

# Bosch Passenger Car Filters

Bodyguard of the engine  
2023



## Contents

1	90 years of Bosch Fuel Filters	4
2	History of Filtration	5
3	Bosch - A Strong Partner in the Filtration Business	6
4	Rely on Bosch Filters	8
5	Bosch Fuel Filters - Diesel	9
6	Bosch Fuel Filters - Gasoline (Petrol)	11
7	Bosch Fuel Filters in Comparison	12
8	Bosch Oil Filters	13
9	Bosch Oil Filters in Comparison	15
10	Bosch Air Filters	16
11	Bosch Air Filters in Comparison	18
12	Bosch Cabin Filters	19
13	Bosch Cabin Filters in Comparison	20
14	Application Chart	21

# 90 years of Bosch Fuel Filters: To be continued!

Since 1930, Bosch Fuel Filters have been protecting the injection systems of motor vehicles. They reliably separate particles and water from fuel and contribute to optimum engine performance.

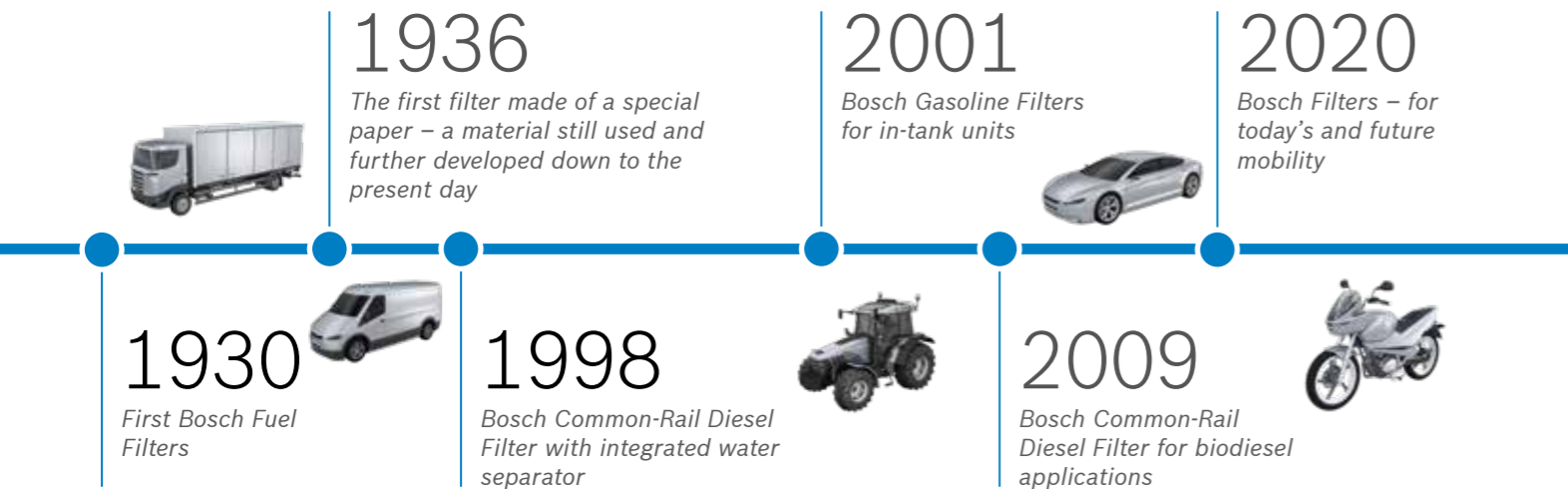

**For tomorrow's mobility, filters will continue being important!**

In future, Bosch will continue to provide accurately fitting and matching filters – no matter which fuels or drive systems will then prevail in the markets. Whether electric drive, fuel cell, or hybrid drive, all of these powertrain systems need clean water, oil, or air for battery and / or engine cooling. And cabin filters will also continue to ensure clean air inside the cabin!



## History of Filtration

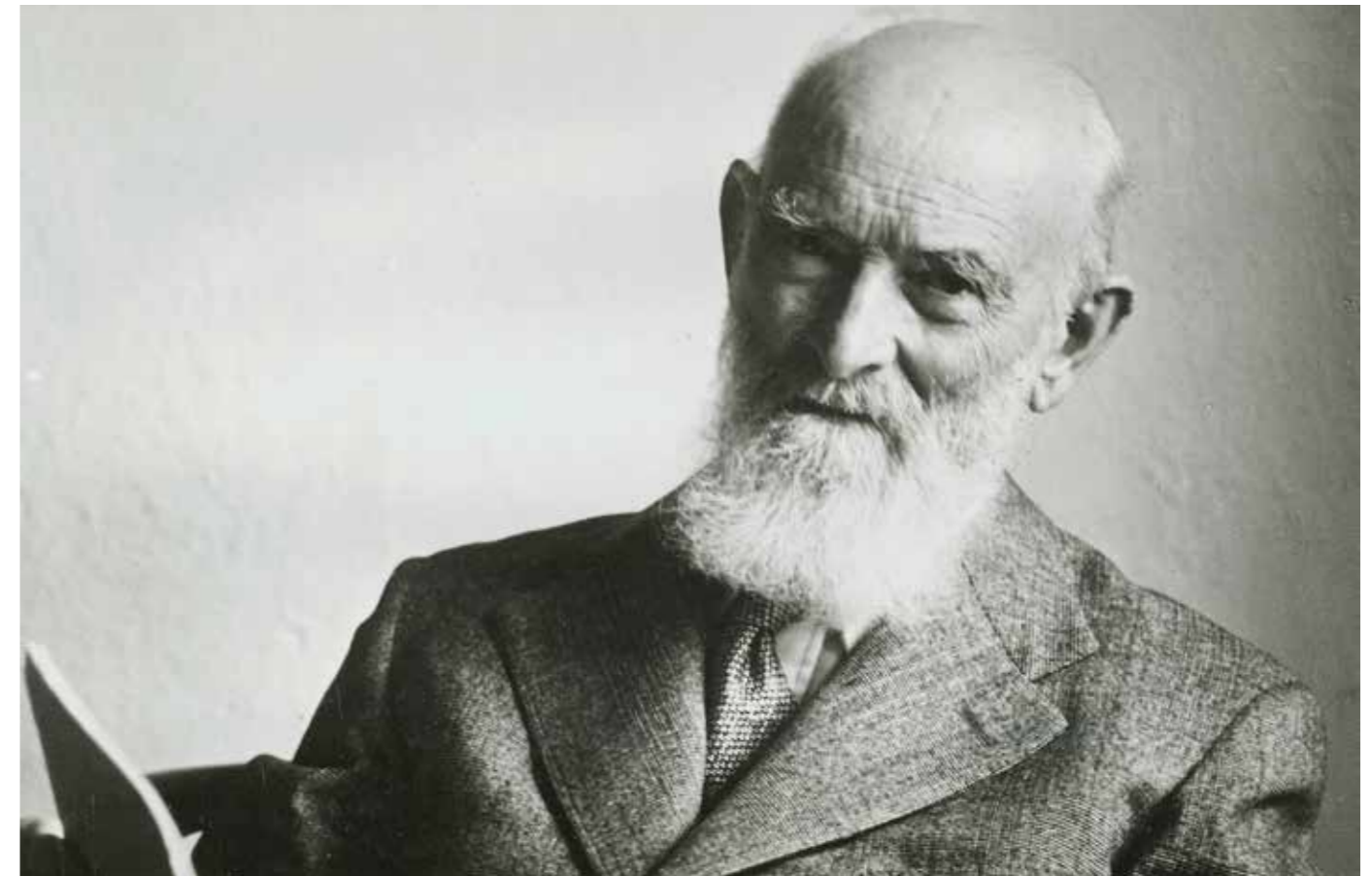

### Understanding Filtration

Bosch filters protect all the important and expensive components in vehicles, especially vehicles with modern gasoline and diesel injection systems which have lower tolerance levels. State-of-the-art technology is used to develop Bosch filters. As a result they are highly reliable in protecting the engine components from the smallest of dirt particles, abrasive particles, and water.

### Why filtration?

- ▶ Engine protection
- ▶ Reduced wear
- ▶ Increased fuel efficiency
- ▶ Environmental protection

### Consequences of inefficient filtration

- ▶ High fuel consumption
- ▶ Expensive damage to fuel injection parts
- ▶ Smoke, poor starting, and rough idling

### Filtration competence for over 80 years

In the beginning of motorised travel, blocked carburettor jets due to contaminated fuel was one of the most common causes for breakdowns.

### Bosch fuel filters solved this problem more than 80 years ago

In 1936, Bosch broke new ground and used a special paper in its filters – a material that has been constantly developed and remains in use to this day.

Ever since the first fuel filters were manufactured back in 1930, they had to meet increasingly strict performance requirements in line with advancements in engine technology. Nowadays, filters play a significant role in a vehicle's performance, economy, and emission values.

Drawing on this exemplary experience and ingenuity, Bosch is currently advancing filter technology and will continue to do so in the future.

# Bosch – A Strong Partner in the Filtration Business

**Satisfied customers, little effort required for warehousing and ordering, consistent use of the latest technologies – numerous USPs signify Bosch filters:**

- ▶ Safety, thanks to first-class product quality
- ▶ Complete range consisting of more than 2,000 filters from a single source
- ▶ Market coverage of 95 %
- ▶ Updated product range with more than 200 new additions each year
- ▶ High availability of goods, in more than 100 countries across the globe
- ▶ Strategic partner for the future through training courses and seminars
- ▶ Strong brand that is trusted by its customers

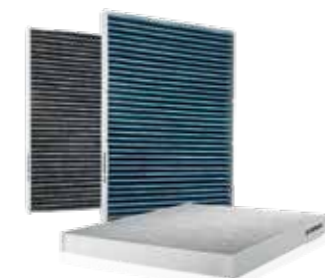

Bosch Oil Filters	Bosch Fuel Filters	Bosch Air Filters	Bosch Cabin Filters
<p>Task: To protect the engine from foreign particles, such as rust or minute pieces of metal in the oil.</p>	<p>Task: To protect the injection system and the engine from foreign particles, water, and other residue in fuel.</p>	<p>Task: To protect the engine against dirt particles in the intake air.</p>	<p>Information: Harmful pollutants like dust, pollen, fungus, and foul-smelling gases fill the air in the car leading to health-related issues. Cabin filters from Bosch absorb up to 100% of all pollen, dust particles, foul-smelling gases, and other harmful pollutants entering the vehicle's interior through its heating, ventilating, and air-conditioning systems, assuring a healthy and hygienic ambience inside the car</p>

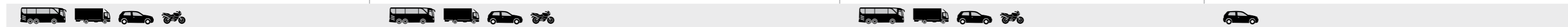



## Rely on Bosch Filters for assured quality and protection

Bosch Filters protect all the crucial components of your vehicle. Our technical expertise and top-of-the-line manufacturing processes and technologies enable us to supply superior and long-lasting products. Manufactured using high-quality materials and designed as per OE specifications, Bosch filters offer uncompromising quality and uninterrupted performance.

## Five steps of quality assurance

### Development

When it comes to development of new filters, our engineering team sticks to precisely defined milestones and follows a well-defined procedure.

### Production

High-quality materials, neat and accurate processing, and well-defined quality checks ensure that we deliver consistently high-quality filters.

### Release

Every Bosch filter is released to the market only after it passes a stringent final round of technical tests.

### Checks

Bosch filters are subjected to random sample tests before being stocked.

### Field observation / monitoring

If a fault is detected, it is taken as a basis to learn and prevent the errors from recurring. In case of a complaint, the cause of the reported problem is analysed and the results are passed on to the engineering team.



## Bosch Fuel Filters – Diesel

### From the specialists for injection systems

#### Task of Bosch Fuel Filters

- To protect the injection system and engine components from any foreign matter, such as dust and other residues in the fuel
- To safeguard against water in the fuel



### Bosch Diesel Filters

#### For conventional systems:

##### Technology from the specialists for diesel systems

Diesel filters are used to eliminate foreign matter and separate the water contained in diesel fuel. Bosch filters combine these two functions in an ideal manner.

#### For common rail systems:

**Designed to satisfy the highest standards** Bosch can supply innovative, economical concepts for common rail technologies. Bosch filters are ideally suited to the high injection pressures and tight tolerances encountered in common rail precision technology.

### Change the diesel filter regularly according to the manufacturer's specifications.

#### Consequences of a clogged filter:

- Power loss of the engine, even to the extent of an engine standstill
- Impairment or interruption of the fuel supply
- Increased rate of wear on the engine
- Internal corrosion of engine components

#### The advantages of Bosch Fuel Filters

- Protection of the injection system through high particle separation rate
- Full engine performance thanks to large filter surface and low flow resistance
- Robust housing
- Long, reliable service life through a special filter medium coating

# Bosch Fuel Filters – Gasoline (Petrol)

## Shield your engine from dust, dirt, and grit

Bosch Fuel Filters – Gasoline (Petrol) protect the engine system by removing impurities from the fuel. Filtered fuel helps improve engine performance and increases service life. Bosch manufactures petrol filters for both carburetted vehicles and MPFI vehicles. The filter prevents impurities in the fuel from obstructing the openings of the carburettor / MPFI system, which would in turn cause difficulties in starting the engine and hamper the vehicle's performance.

Petrol Filters from Bosch ensure maximum engine protection, improved mileage, and effective prevention of power loss even under extreme conditions.

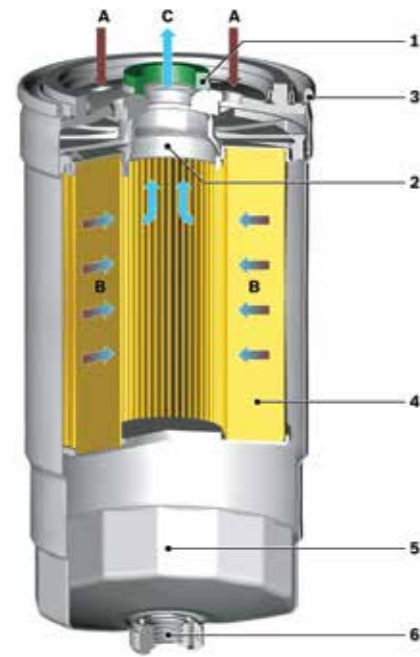

### Explanation

- 1 Sealing
  - 2 Fitting flange
  - 3 Double beading
  - 4 Multilayer filter medium
  - 5 Water chamber
  - 6 Water drain screw
- A Inflow of contaminated diesel  
 B Filtration of the diesel  
 C Cleaned diesel is conveyed to the engine

Features	Advantages	Benefits
Microporous, multilayered filter medium	High particle separation rate	Protection of the expensive injection system
Filter medium with special resin coating	Protection of the filter medium against water and aggressive components in the fuel	Long filter service life
Large filter surface	Excellent dirt collection capacity, low flow resistance	Long filter service life, full engine output
Precise, fuel-resistant connections	No throughput of unfiltered fuel (internal integrity)	Protection of the expensive injection system
Robust finish of the housing	Withstands high pressures (external integrity)	Long filter service life



### Crucial for commercial vehicles:

#### Bosch Diesel Filters with water separators

Due to the high flow rate, water separators are often built into commercial vehicles to pre-filter water and coarse particles. The actual diesel filter then performs the task of finely filtering the fuel.



### Features:











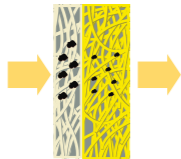
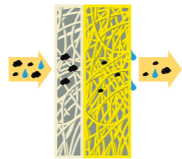

- Application-specific media designed to meet the needs of all kinds of engines
- Long service life and extended service intervals
- Materials, design, and construction of Bosch Petrol Filters contribute to excellent performance in all kinds of operating conditions
- Unmatched fuel-cleansing performance

### The advantages of Bosch Fuel Filters – Gasoline (Petrol)

- Protection of the injection system
- Longer service life
- Optimum engine performance

## Bosch Fuel Filters in comparison

Quality pays off

On the safe side with Bosch filters		Cheap filters – expensive consequences!
High particle separation rate, thanks to microporous multilayer filter medium		
Large dust-holding capacity through high number of pleats		
Reliable filtration thanks to stable pleat geometry		
Corrosion-resistant housing prevents fuel leakages		
Robust connection of the end pleats		
High-quality seal made out of a special rubber prevents any fuel leakage		
Protection cap on the clean side (outlet) of the		

Low-quality filter medium:  
 ▶ Increased engine wear  
 ▶ Injector clogging  
 ▶ Corrosion

Lower number of pleats:  
 ▶ Increased engine wear due to particles  
 ▶ Reduced service life

Unstable pleat geometry:  
 ▶ Insufficient fuel filtration  
 ▶ Increased engine wear

Corrosion caused by spray water:  
 ▶ Hazards caused by leaking fuel  
 ▶ Environmental pollution  
 ▶ Increased engine wear

Bypass of unfiltered fuel caused by missing connection of end pleats:  
 ▶ Increased engine wear

Damaged, porous seal:  
 ▶ Hazards caused by leaking fuel  
 ▶ Environmental pollution

Missing protection cap facilitates filter soiling:

## Bosch Oil Filters

### For optimum engine performance

#### Purpose of the oil

- Minimisation of wear and friction
- Heat dissipation

#### Task of the Bosch Oil Filter

- To protect the engine against impurities in the oil such as dust, metal particles, combustion residue, or soot particles

Change the oil filters regularly according to the vehicle manufacturer's specifications!

#### Consequences of a clogged filter:

##### Urban traffic means stress for the oil

On short-distance trips and in stop-and-go traffic, the oil and the oil filters should be changed more often than the replacement intervals specified by the vehicle manufacturer because frequent cold starts lead to more condensation and excess fuel in the combustion mixture. This means that:

- Unburnt hydrocarbons and condensation enter the oil which leads to premature aging of the oil
- At high engine temperatures, these components evaporate in the oil circuit, which further reduces the lubrication quality

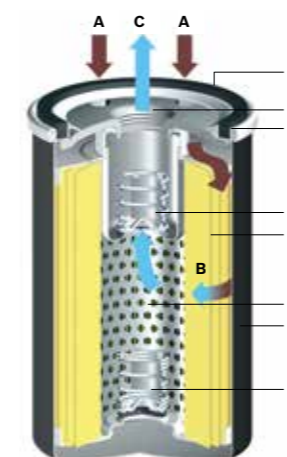

#### Bosch Oil Filters – Design and operation

- 1 Sealing
- 2 Threaded connection
- 3 Double beading
- 4 Non-return valve
- 5 Filter medium
- 6 Support jacket
- 7 Pressure-resistant filter housing
- 8 Bypass valve

#### The advantages of Bosch Oil Filters

- Protection of the engine and retaining engine oil functionality in the long term thanks to high particle separation rate, moisture resistance
- Long service life due to large filter surface  
Protection of the environment and engine as oil losses are prevented
- Immediate engine lubrication during cold starts because of non-return valve

- A Inflow of contaminated oil
- B Filtration of the oil
- C Clean oil is conveyed to the engine



## Bosch Oil Filter designs



### Oil filter insert

The oil filter housing is connected permanently to the engine block. When changing the filter, only the filter insert and the seals are replaced.



### Oil filter exchange box

When changing the filter, the entire oil filter is replaced and bolted directly to the engine block using a connecting flange.

Features	Advantages	Benefits
Microporous, multilayered, specially impregnated filter medium	High particle separation rate, moisture resistance, tensile strength	Protection of the engine, long service life of the engine oil
Large filter surface	Excellent dirt collection capacity, low flow resistance	Long filter service life
Seals made of special rubber	Prevention of oil loss	Protection of the environment and of the engine
Bypass valve	Reliable engine lubrication even in cold conditions (viscous oil) or with silted-up filter	Protection of the engine
Non-return valve	Immediate engine lubrication after a cold start	Protection of the engine
Corrosion-resistant housing materials	No rusting due to spray water, no oil loss	Protection of the environment and of the engine

### How it works

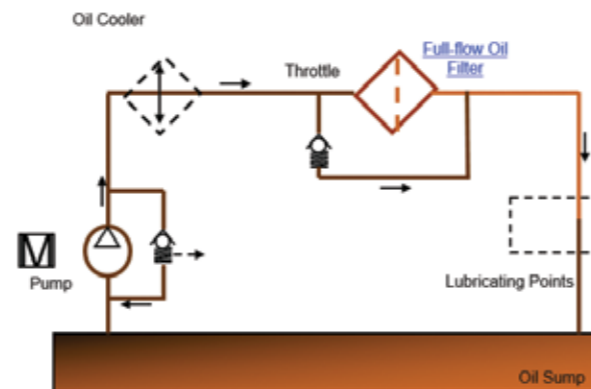

Bypass Circuit Diagram

## Oil Bypass Filtration

### Specially for commercial vehicles

In commercial vehicles, a large amount of particles get collected in the oil over time, above all soot particles. This causes premature aging of the oil and engine wear. In addition to the main flow filter, which filters the entire quantity of oil with each cycle, commercial vehicles usually also have a bypass filter. This cleans 5 to 10% of the oil in a separate circuit.



**Fresh engine oil**  
Good lubrication properties



**Aged engine oil**  
With soot contamination, poor lubrication properties

## Bosch Oil Filters in comparison

### Quality pays off

On the safe side with Bosch filters		Cheap filters – expensive consequences!
High particle separation rate, thanks to microporous filter medium with special impregnation		Low-quality filter medium: ▶ Increased engine wear ▶ Possible increase in fuel consumption
Large dust-holding capacity through large number of pleats		Low number of pleats: ▶ Poor filtration ▶ Increased wear or even engine damage ▶ Reduced service life
Reliable filtration thanks to meticulous processing and stable pleat geometry		Unstable pleat geometry, excess of adhesives: ▶ Increased engine wear ▶ Possible increase in fuel consumption
Corrosion-resistant housing prevents oil leakages		Corrosion caused by spray water: ▶ Increased wear or even engine damage ▶ Environmental pollution caused by leaking oil
Robust felt ring prevents oil leakages		Poorly fitting felt ring: ▶ Loss of internal integrity, poor filtration of oils ▶ Increased wear leading to engine damage
High-quality seal made of a special rubber prevents oil leakages		Damaged, porous seal: ▶ Increased wear or even engine damage ▶ Environmental pollution caused by leaking oil
Accurately set valve-opening pressure ensures reliable engine lubrication – even under cold conditions and in case of a clogged filter.		Poor functioning of the bypass valve: ▶ Increased wear or even engine damage ▶ Bursting of the oil filter



# Bosch Air Filters

## Top quality engine protection



### Tasks of the Bosch Air Filter

- Protect the engine against dirt particles in the intake air
- Protect the engine against wear
- Safeguard the air supply for the mixture preparation
- Reduce the noise level

### Tight fit

The seal in air filters must remain soft, supple, and fit exactly during the entire service life, in order to prevent unfiltered air from reaching the engine. This is why Bosch Air Filters come with a 'high quality' seal and are manufactured in strict compliance with the requirements for each vehicle.

### Change the air filters regularly according to the vehicle manufacturer's specifications

#### Consequences of a clogged filter:

- Poor air-fuel mixture preparation, resulting in reduced engine power and increased pollutant emissions
- More fuel consumption
- Increased wear in the engine due to particles
- Problems when starting the engines

### The advantages of Bosch Air Filters

- High efficiency and reliability during the entire filter service life thanks to robust pleat geometry
- Long service life and thus protection of the engine thanks to high particle separation rate, moisture resistance, and tensile strength, as well as chemical and thermal stability
- Lower fuel consumption thanks to excellent dirt collection capacity and low flow resistance

### Design and operation of the Bosch Air Filter

Microfibre filter medium with artificial resin impregnation

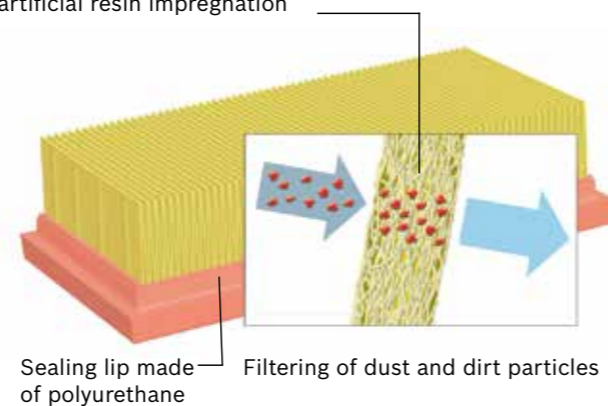

### Why air filters must not be cleaned

To burn one litre of fuel, you need 10,000 litres of air. That makes it all the more important that air filters work perfectly and are changed regularly. If you try to extend the service life of an air filter by cleaning the filter medium with compressed air, it would not serve the purpose.

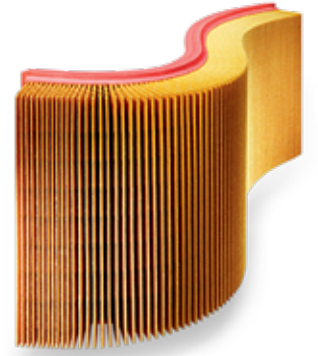







The risks are as follows:

- ▶ Compressed air destroys the folds in the filter medium and so impairs the operation of the air filter
- ▶ Impurities enclosed in the filter medium are released again
- ▶ Dirt and particles penetrate into the engine, leading to loss of power and, in the worst-case scenario, damage to the engine

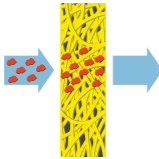
Features	Advantages	Benefits
Microporous, specially impregnated filter medium	High particle separation rate, moisture resistance, tensile strength, chemical and thermal stability	Long filter service life, protection of the engine
Filter medium with special embossing	Robust fold geometry	Full efficiency during the entire filter service life
Large filter surface	Excellent dirt collection capacity, low flow resistance	Long filter service life, low fuel consumption
Precise fit, high-quality sealing material made of polyurethane	Compensation for unevenness in the housing, prevention of unfiltered, unmetred air (bypass)	Optimal mixture preparation, protection against wear

# Bosch Air Filters in comparison

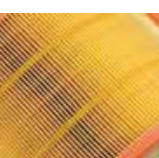
## Quality pays off

On the safe side with Bosch filters		Cheap filters – expensive consequences!
High particle separation rate, thanks to microporous filter medium		Low-quality filter medium: <ul style="list-style-type: none"> <li>▶ Increased engine wear</li> <li>▶ Accumulation of dirt on the air-mass meter</li> </ul>
Large dust-holding capacity thanks to high number of pleats		Low number of pleats: <ul style="list-style-type: none"> <li>▶ Reduced service life</li> </ul>
Moisture resistance thanks to impregnation with special resin		Conglomeration of pleats due to moisture: <ul style="list-style-type: none"> <li>▶ Decreased engine performance</li> <li>▶ Increased fuel consumption</li> </ul>
Inflammation protection thanks to special coating		Fire hazard caused by aspirated cigarette stubs or backfire: <ul style="list-style-type: none"> <li>▶ Vehicle fire</li> </ul>
Permanently stable pleat geometry thanks to sufficiently dimensioned glue beads		Unstable pleat geometry: <ul style="list-style-type: none"> <li>▶ Reduced service life</li> <li>▶ Reduced engine performance</li> <li>▶ Increased fuel consumption</li> </ul>
No bypass of unfiltered air thanks to high-quality polyurethane seal		Poor processing, low-quality sealing material: <ul style="list-style-type: none"> <li>▶ Increased engine wear</li> <li>▶ Accumulation of dirt on the air-mass meter</li> </ul>
No loss of filter surface thanks to careful processing of the sealing material		Excessive use of sealing material: <ul style="list-style-type: none"> <li>▶ Short service life</li> <li>▶ Reduced engine performance</li> </ul>

# Bosch Cabin Filters

## For improved air quality and refreshing interiors

The air inside the vehicle cabin is often polluted due to pollen, dust particles, or emissions. Pollution levels inside the vehicle are often up to six times higher than the levels outside of it, since the emissions from the vehicle ahead are routed directly into the vehicle interior. Cabin filters from Bosch absorb up to 100% of pollen, dust particles, foul-smelling gases, and other harmful pollutants, thus preventing them from entering the interior through its heating, ventilating, or air conditioning systems, assuring a healthy and hygienic ambience inside the car.



### The advantages of Bosch Cabin Filters:

- Filters up to 100% of dust and dirt particles, pollen, bacteria, and spores
- Consistent functionality during the entire filter service life, thanks to its excellent stability
- Filters even the smallest particle, down to the size of 0.0025 mm, offering enhanced protection
- Enhanced fresh air in the cabin, thanks to its considerable air flow

### Features and benefits:

- Multilayered filter medium with a large surface to ensure filtering of both large particles and small pollen spores & bacteria
- Electrostatically charged microfibre fleece filters out even the smallest, respirable particles down to the size of 0.0025 mm
- Allows only fresh air into the cabin, improving driver comfort, and eliminating misted windows
- Protects the passengers from allergies, bacteria, and foul smell

**Important: Cabin filters should be replaced every 15,000 km, or in accordance with manufacturers' recommendations. But you will know it's time to change the filter, when you notice the following occurrences: The windows will fog up faster, dust particles will accumulate inside the vehicle, and the air will smell less pleasant.**

### Bosch Cabin Filters are available in 2 variants:

#### Standard Cabin Filter

- Captures up to 100% of dust and dirt particles, pollen, and bacteria
- Ensures optimum filtration due to the several layers of different polymer fibres









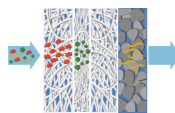
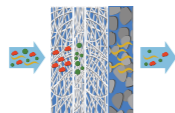

#### Activated Carbon Cabin Filter

- Captures up to 100% of all dust & dirt particles, pollen, and bacteria
- Guarantees flow of fresh air, even in a tunnel or traffic jam
- Filtration of foul-smelling, harmful gases
- Improved level of comfort and concentration
- Improved view of the road due to minimum deposits on the windshield

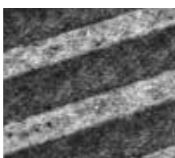
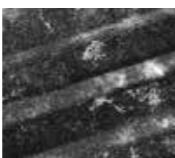
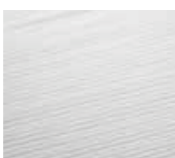

# Bosch Cabin Filters in comparison

Quality pays off

On the safe side with Bosch filters	Cheap filters – unpleasant consequences!
<p>Pure air through several well-coordinated filter layers</p> 	<p>Too thin and badly coordinated filter layers:</p> <ul style="list-style-type: none"> <li>▶ Particles and pollen get into the interior of the vehicle</li> </ul> 
<p>Reliable filtration thanks to high-quality fibres</p> 	<p>Insufficient fibres and low fibre quality:</p> <ul style="list-style-type: none"> <li>▶ Low filtration performance</li> </ul> 
<p>Stability and increased filter surface through special embossing of the filter medium</p> 	<p>Low-quality filter medium without embossing:</p> <ul style="list-style-type: none"> <li>▶ Reduced service life</li> </ul> 
<p>Reliable adsorption of harmful gases and odours with:</p> <ul style="list-style-type: none"> <li>▶ Sufficient activated carbon</li> <li>▶ High quality</li> </ul> 	<p>Insufficient and badly distributed low-quality activated carbon:</p> <ul style="list-style-type: none"> <li>▶ Harmful gases get into the vehicle interior</li> </ul> 
<p>Stable pleat geometry – even when exposed to humidity</p> 	<p>Unstable pleat geometry:</p> <ul style="list-style-type: none"> <li>▶ Unreliable filtration</li> </ul> 
<p>Shape is perfectly geared to the installation space – and is still highly flexible in order to ease the installation under difficult circumstances</p> 	<p>Incorrect fit and bad workmanship:</p> <ul style="list-style-type: none"> <li>▶ Bypass of unfiltered air and accumulation of dirt on the air conditioning</li> </ul> 
<p>Practice-approved installation instructions ease the filter replacement</p> 	<p>Missing installation instructions:</p> <ul style="list-style-type: none"> <li>▶ Loss of time during filter replacement</li> </ul> 

## Brand wise Filter Application Chart

Model Description	Air Filter	Cabin Filter	Fuel Filter	Oil Filter
<b>AUDI</b>				
A3 [8PA] Sportback		1 987 432 097		
A3 [8PA] Sportback		1 987 432 597		
A3 [8V1, 8VK]	F 026 400 287	0 986 628 630		
A3 [8V1, 8VK]	F 026 400 287	1 987 432 540		
A3 [8V1, 8VK] (D) 105 Kw (2014.08 -2020.10)			1 457 070 014	
A3 [8V1, 8VK] (D) 105 Kw (2014.08 -2020.10)			F 026 402 254	
A3 [8VS, 8VM] Limousine, Q2 [GAB, GAG], TT [FV3, FVP] Coupe, A3 [8V7, 8VE] Cabriolet	F 026 400 287	0 986 628 630		F 026 407 278
A3 [8VS, 8VM] Limousine, Q2 [GAB, GAG], TT [FV3, FVP] Coupe, A3 [8V7, 8VE] Cabriolet	F 026 400 287	1 987 432 540		F 026 407 278
A4 [8E2, B6]	1 457 433 046	1 987 432 371		
A4 [8EC, B7]	1 457 433 046	1 987 432 371	0 450 906 374	1 457 429 619
A4 [8K2, B8] (D) 130 Kw (2013.09 -2015.12)				F 026 407 023
A4 [8W2, 8WC, B9]		0 986 628 565	F 026 402 808	
A4 [8W2, 8WC, B9] (D) 140 Kw (2017.02 -2018.06)	F 026 400 422			
A4 [8W2, 8WC, B9] (P) 110 Kw (2015.08 -2019.10)	F 026 400 425			
A5 [8F7] Cabriolet	F 026 400 650	0 986 628 622		
A5 [8F7] Cabriolet	F 026 400 650	1 987 432 369		
A6 [4F2, C6]		1 987 432 422	F 026 403 012	
A6 [4F2, C6] (D) 125 Kw (2008.10 -2011.08), A4 [8K2, B8] (D) 105 Kw (2007.11 -2012.03)				1 457 429 192
A6 [4FH, C6] Allroad		1 987 432 422		
A6 [4G, C7]	F 026 400 289	0 986 628 559		F 026 407 278
A6 [4G, C7]	F 026 400 289	1 987 432 548		F 026 407 278
A6 [AU561]		1 987 432 422		0 451 103 313
A7 [4G, C7] Sportback		0 986 628 559	F 026 402 808	F 026 407 122
A7 [4G, C7] Sportback		1 987 432 548	F 026 402 808	F 026 407 122
A8 [4E, D3]	F 026 400 629		0 450 905 318	
A8 [4E, D3]	F 026 400 629		0 450 906 458	
A8 [4E, D3] (D) 171 Kw (2004.01 -2010.07), A8 [4H, D4] (D) 258 Kw (2009.11 -2014.04), A6 [4F2, C6] (D) 176 Kw (2008.10 -2011.08), Q7 [4LB] (D) 250 Kw (2009.06 -2010.05), Q7 [4LB] (D) 171 Kw (2006.08 -2008.05), A6 [4FH, C6] Allroad (D) 132 Kw (2006.05 -2008.10)				F 026 407 066
A8 [4E, D3] (D) 171 Kw (2004.01 -2010.07), Q7 [4LB] (D) 171 Kw (2006.08 -2008.05), A6 [4F2, C6] (D) 165 Kw (2004.04 -2006.05), A6 [4FH, C6] Allroad (D) 132 Kw (2006.05 -2008.10)				F 026 407 002
A8 [4H, D4]		0 986 628 559		
A8 [4H, D4]		1 987 432 548		
A8 [4H, D4] (D) 184 Kw (2011.01 -2016.02)				F 026 407 122



## Brand wise Filter Application Chart

Model Description	Air Filter	Cabin Filter	Fuel Filter	Oil Filter
A8 [4H, D4] (P) 320 Kw (2013.10 -2018.01), A8 [4H, D4] (P) 309 Kw (2013.07 -2014.04)				F 026 407 313
A8 [4H, D4] (P) 368 Kw (2011.01 -2014.04), A8 [4E, D3] (P) 331 Kw (2004.02 -2010.07), A8 [4H, D4] (P) 368 Kw (2013.09 -2018.01)				F 026 407 344
A8 [4N, D5]		0 986 628 565		F 026 407 274
Q3 [8U]	1 987 429 404	1 987 432 097		F 026 407 023
Q3 [8U]	1 987 429 404	1 987 432 597		F 026 407 023
Q3 [8U] (D) 103 Kw (2013.08 -2015.04), Q3 [8U] (D) 130 Kw (2013.08 -2015.04)			F 026 402 248	
Q3 [8U] (D) 103 Kw (2013.08 -2015.04), Q3 [8U] (D) 130 Kw (2013.08 -2015.04)			F 026 402 809	
Q5 [8RB]		0 986 628 622		F 026 407 122
Q5 [8RB]		1 987 432 369		F 026 407 122
Q7 [4LB]	F 026 400 182	1 987 432 431	1 457 070 010	
Q7 [4LB] (P) 257 Kw (2006.03 -2010.05), R8 [4S3, 4SP], A8 [4H, D4] (P) 273 Kw (2009.11 -2014.04)				F 026 407 011
Q7 [4MB, 4MG] (D) 183 Kw (2015.06 -2019.12)				F 026 407 270
Q7 [4MB, 4MG] (P) 185 Kw (2017.09 -2019.12)				F 026 407 278
Q7 [4MB, 4MG] (P+E) 250 Kw (2019.07-->)				F 026 407 274
R8 [423], R8 [429] Spyder		1 987 432 422	F 026 403 012	F 026 407 011
RS5 [8T3] Coupe		0 986 628 622		F 026 407 011
RS5 [8T3] Coupe		1 987 432 369		F 026 407 011
RS7 [4G, C7] Sportback, S6 [4G, C7], RS6 [4G, C7] Avant		0 986 628 559		F 026 407 313
RS7 [4G, C7] Sportback, S6 [4G, C7], RS6 [4G, C7] Avant		1 987 432 548		F 026 407 313
S5 [8F7] Cabriolet, S4 [8K2, B8], A4 [8K2, B8]		0 986 628 622		
S5 [8F7] Cabriolet, S4 [8K2, B8], Q5 2.0 TDI quattro, A4 [8K2, B8]		1 987 432 369		
S5 [F5A, F5F] Sportback	F 026 400 677	0 986 628 565		F 026 407 274
TT [8J3] Coupe		1 987 432 097		1 457 429 192
TT [8J3] Coupe		1 987 432 097		F 026 407 080
TT [8J3] Coupe		1 987 432 597		1 457 429 192
TT [8J3] Coupe		1 987 432 597		F 026 407 080
TT [8J3] Coupe (P) 155 Kw (2010.05 -2014.06)	1 987 429 404		0 450 905 959	
TT [8J3] Coupe (P) 184 Kw (2006.07 -2010.06)	F 026 400 180		F 026 403 006	
TT [8N3] Coupe	1 457 433 714	1 987 432 300	0 450 905 318	
TT [8N3] Coupe (P) 110 Kw (2001.01 -2006.06)				0 451 103 314
TT [8N3] Coupe (P) 110 Kw (2001.01 -2006.06)				0 986 MF0 081
e-tron [GEN], Q7 [4MB, 4MG], e-tron [GEA] Sportback		0 986 628 565		
<b>BENTLEY</b>				
Bentayga [4V1]		0 986 628 565		

## Brand wise Filter Application Chart

Model Description	Air Filter	Cabin Filter	Fuel Filter	Oil Filter
Continental Flying Spur [3W]			0 450 905 318	F 026 407 344
Continental GT [393]			0 450 905 318	
Continental GT [393] (P) 412 Kw (2003.06 -2012.10), Flying Spur [4W] (P+A) 453 Kw (2013.03 -2015.05), Continental GT [393] (P+A) 460 Kw (2012.09 -2014.05)				F 026 407 344
Continental GT [393] (P+A) 388 Kw (2016.05 -2017.11), Flying Spur [4W] (P) 373 Kw (2014.02 -2015.08), Continental GT [393] (P) 373 Kw (2012.01 -2014.12)				F 026 407 313
Mulsanne [3Y]		0 986 628 559		
Mulsanne [3Y]		1 987 432 548		
<b>BMW</b>				
1 [F 20]	F 026 400 374		F 026 402 824	
1 [F 20] (P) 100 Kw (2013.09 -2015.02)				F 026 407 173
2 [F 44] Gran Coupe	F 026 400 360	1 987 435 582	F 026 402 257	F 026 407 277
3 [E 90]	F 026 400 119	1 987 432 424		
3 [E 90] (D) 130 Kw (2007.09 -2010.03)			F 026 402 085	F 026 407 072
3 [E 90] (D) 130 Kw (2007.09 -2010.03)			F 026 402 106	F 026 407 072
3 [E 90] (P) 110 Kw (2005.03 -2011.12), X 1 [E 84] (P) 100 Kw (2010.03 -2015.06)				1 457 429 262
3 [E 90], 3 [E 93] Cabrio	F 026 400 119	0 986 628 608		
3 [E 93] Cabrio (D) 180 Kw (2009.03 -2013.09)		1 987 432 424	F 026 402 085	F 026 407 094
3 [E 93] Cabrio (D) 180 Kw (2009.03 -2013.09)		1 987 432 424	F 026 402 106	F 026 407 094
3 [E 93] Cabrio (P) 309 Kw (2008.03 -2013.10), 3 [E 92] Coupe		1 987 435 587		F 026 407 255
3 [F 30]			F 026 402 824	
3 [F 30] (D) 135 Kw (2012.02 -2016.03)	F 026 400 374			F 026 407 123
3 [F 30] (P) 135 Kw (2015.07 -2018.10)	F 026 400 270			F 026 407 205
3 [F 30] (P) 160 Kw (2012.02 -2015.08), 3 [F 30] (P) 135 Kw (2012.03 -2018.10)	F 026 400 374			F 026 407 175
3 [F 34] GT	F 026 400 374		F 026 402 824	F 026 407 123
3 [G 20]	F 026 400 692	0 986 628 580	F 026 402 358	F 026 407 205
3 [G 20]	F 026 400 692	1 987 435 604	F 026 402 358	F 026 407 205
330 Li 2.0 T	F 026 400 270			
330 i			0 450 904 058	
5 [E 60]		1 987 432 402	0 450 906 457	1 457 429 252
5 [E 60] (D) 170 Kw (2005.09 -2007.02), 7 [E 65] (D) 170 Kw (2005.04 -2008.10)	1 457 433 589			
5 [E 60] (P) 130 Kw (2005.03 -2010.02), 5 [E 60] (P) 187 Kw (2005.03 -2010.02), 5 [E 60] (P) 160 Kw (2007.03 -2008.07)	1 457 433 094			
5 [F 07] GT	F 026 400 365	0 986 628 558	0 450 906 457	F 026 407 094
5 [F 07] GT	F 026 400 365	1 987 435 064	0 450 906 457	F 026 407 094

### Brand wise Filter Application Chart

Model Description	Air Filter	Cabin Filter	Fuel Filter	Oil Filter
5 [F 10] (D) 150 Kw (2010.03 -2011.08), 5 [F 10] (D) 180 Kw (2010.03 -2011.08)	F 026 400 365			F 026 407 094
5 [F 10] (D) 160 Kw (2011.09 -2016.10), 5 [F 10] (D) 100 Kw (2010.05 -2016.10)	F 026 400 365			F 026 407 123
5 [F 10] (P) 135 Kw (2012.01 -2013.09)	F 026 400 149			F 026 407 175
5 [F 10] (P) 135 Kw (2012.01 -2013.09)	F 026 400 149			F 026 407 178
5 [F 10] (P) 225 Kw (2010.09 -2016.10), 5 [F 10] (P) 225 Kw (2010.03 -2016.10)				F 026 407 228
5 [F 10] (P) 412 Kw (2011.09 -2016.10)	F 026 400 508			F 026 407 158
5 [G 30]	F 026 400 713	0 986 628 571	F 026 402 358	F 026 407 205
6 [E 63], 6 [E 64] Cabrio	1 457 433 101	1 987 432 402		
6 [F 06] Gran Coupe (D) 230 Kw (2012.05 -2018.10), 6 [F 13] Coupe (D) 230 Kw (2012.03 -2017.10), X 1 [E 84] (D) 135 Kw (2012.07 -2015.06), 6 [F 12] Cabrio (D) 230 Kw (2012.03 -2018.05), 7 [F 02] (D) 180 Kw (2012.07 -2015.05), X 3 [F 25] (D) 120 Kw (2010.10 -2017.08), X 3 [F 25] (D) 155 Kw (2011.04 -2017.08), 1 [F 20] (D) 105 Kw (2013.09 -2015.02), 5 [F 10] (D) 190 Kw (2011.09 -2016.10)				F 026 407 123
6 [F 06] Gran Coupe, 6 [F 12] Cabrio, 5 [F 10], 6 [F 13] Coupe		0 986 628 558	0 450 906 457	
6 [F 06] Gran Coupe, 6 [F 12] Cabrio, 5 [F 10], 6 [F 13] Coupe		1 987 435 064	0 450 906 457	
6 [F 14] Gran Coupe	F 026 400 508	0 986 628 558		F 026 407 158
6 [F 14] Gran Coupe	F 026 400 508	1 987 435 064		F 026 407 158
7 [E 65]			0 450 906 457	1 457 429 252
7 [E 65] (P) 327 Kw (2002.12 -2008.10)	1 457 433 091			
7 [F 02]	F 026 400 365	0 986 628 558	0 450 906 457	
7 [F 02]	F 026 400 365	1 987 435 064	0 450 906 457	
7 [F 02] (D) 180 Kw (2009.03 -2012.06), X 6 [E 71] (D) 155 Kw (2010.04 -2014.06), X 6 [E 71] (D) 225 Kw (2010.04 -2014.06)				F 026 407 094
7 [G 12]	F 026 400 713	0 986 628 571	F 026 402 358	
7 [G 12] (D) 155 Kw (2015.09 -2020.06)				F 026 407 264
7 [G 12] (P+E) 190 Kw (2016.07 -2019.02), X 3 [F 25] (D) 120 Kw (2014.04 -2017.08), 5 [F 10] (D) 120 Kw (2014.06 -2016.10)				F 026 407 205
8 [G 16] Gran Coupe		0 986 628 571		F 026 407 264
M 3 [F 80], M 4 [F 82], M 2 [F 87]	F 026 400 508			
X 1 [E 84]	F 026 400 119	0 986 628 608	F 026 402 106	
X 1 [E 84]	F 026 400 119	1 987 432 424	F 026 402 106	
X 1 [E 84] (D) 120 Kw (2009.10 -2012.06)				F 026 407 072
X 1 [F 48]	F 026 400 360		F 026 402 257	
X 1 [F 48] (D) 120 Kw (2015.10 -2019.07), X 1 [F 48] (P) 141 Kw (2017.05 -2018.03), X 1 [F 48] (D) 120 Kw (2015.11 -2019.07)		1 987 435 538		F 026 407 204

### Brand wise Filter Application Chart

Model Description	Air Filter	Cabin Filter	Fuel Filter	Oil Filter
X 1 [F 48] (D) 120 Kw (2015.10 -2019.07), X 1 [F 48] (P) 141 Kw (2017.05 -2018.03), X 1 [F 48] (D) 120 Kw (2015.11 -2019.07)		1 987 435 582		F 026 407 204
X 1 [F 48] (D) 140 Kw (2017.11-->), X 1 [F 48] (P) 141 Kw (2019.09-->)		1 987 435 582		F 026 407 277
X 3 [E 83]		1 987 432 336	0 450 906 457	F 026 407 072
X 3 [E 83] (D) 120 Kw (2008.09 -2010.08)	F 026 400 147			
X 3 [E 83] (P) 160 Kw (2006.09 -2008.08)	F 026 400 463			
X 3 [F 25]	F 026 400 366	1 987 432 242	F 026 402 106	
X 3 [F 25]	F 026 400 366	1 987 432 542	F 026 402 106	
X 5 M [F 85], X 6 M [F 86]		1 987 432 419		F 026 407 158
X 5 [E 70]		1 987 432 419	0 450 906 457	
X 5 [E 70] (D) 155 Kw (2010.04 -2013.06)	F 026 400 366			F 026 407 094
X 5 [E 70] (D) 173 Kw (2008.10 -2010.03)	1 457 433 589			1 457 429 252
X 5 [F 15], X 6 [F 16]		1 987 432 419	0 450 906 457	F 026 407 123
X 6 [E 71]	F 026 400 366	1 987 432 419	0 450 906 457	
X 6 [E 71] (P) 408 Kw (2009.09 -2014.06), 6 [F 13] Coupe (P) 300 Kw (2011.10 -2012.06), 7 [G 12] (P) 330 Kw (2015.11 -2018.12), 7 [G 12] (P) 448 Kw (2017.05 -2018.12), X 6 [E 71] (P) 300 Kw (2008.05 -2014.06), 7 [F 02] (P) 300 Kw (2008.11 -2012.06), 7 [F 02] (P) 400 Kw (2009.09 -2015.04), X 5 [E 70] (P) 300 Kw (2010.04 -2013.06), 7 [G 12] (P) 442 Kw (2016.09-->), 6 [F 06] Gran Coupe (P) 330 Kw (2012.07 -2018.10), 6 [F 12] Cabrio (P) 300 Kw (2011.03 -2014.01)				F 026 407 158
X 7 [G 07]		0 986 628 571	F 026 402 358	F 026 407 264
Z 4 [E 89]		1 987 432 368		
i 8 [I 12]		1 987 435 623		F 026 407 204
<b>BMW Mini</b>				
Mini [F 54] Clubman	F 026 400 360			F 026 407 204
Mini [F 54] Clubman (P) 120 Kw (2015.10 -2018.06)		1 987 435 538		
Mini [F 54] Clubman (P) 120 Kw (2015.10 -2018.06)		1 987 435 582		
Mini [F 56]	F 026 400 360		F 026 402 257	
Mini [F 56] (P) 120 Kw (2014.03 -2018.06), Mini [F 56] (D) 85 Kw (2014.03 -2018.02)		1 987 435 538		F 026 407 204
Mini [F 56] (P) 120 Kw (2014.03 -2018.06), Mini [F 56] (D) 85 Kw (2014.03 -2018.02)		1 987 435 582		F 026 407 204
Mini [F 56] (P) 155 Kw (2017.09 -2018.03)		1 987 435 582		F 026 407 277
Mini [F 57] Cabrio	F 026 400 360	1 987 435 582		F 026 407 204
Mini [R 56] (P) 85 Kw (2010.03 -2013.11), Mini [R 57] Cabrio (P) 85 Kw (2010.03 -2015.06), Mini [R 60] Countryman (P) 85 Kw (2010.09 -2016.10)	F 026 400 050			
Mini [R 56] (P) 85 Kw (2010.03 -2013.11), Mini [R 57] Cabrio (P) 85 Kw (2010.03 -2015.06), Mini [R 60] Countryman (P) 85 Kw (2010.09 -2016.10)	F 026 400 549			

## Brand wise Filter Application Chart

Model Description	Air Filter	Cabin Filter	Fuel Filter	Oil Filter
Mini [R 56], Mini [R 57] Cabrio		0 986 628 579		
Mini [R 56], Mini [R 57] Cabrio		1 987 432 296		
Mini [R 60] Countryman		0 986 628 579	F 026 402 824	F 026 407 123
Mini [R 60] Countryman		1 987 432 296	F 026 402 824	F 026 407 123
Mini [R 60] Countryman (P) 135 Kw (2010.09 -2014.06), Mini [R 56] (P) 135 Kw (2010.03 -2013.11)	F 026 400 219			
<b>CHEVROLET</b>				
Beat 0.9D	F 002 H24 974		F 002 H24 990	
Beat 1.2i				F 002 H24 521
Captiva [C140] (D) 135 Kw (2009.01-->)			F 026 402 353	
Captiva [C140] (D) 135 Kw (2009.01-->)			F 026 402 360	
Cruze [J300]				F 026 407 006
Spark 1.0 LPG/CNG, Spark 1.0 i	1 987 429 166	1 987 432 171		
Tavera 2.0D	F 002 H24 400		F 002 H23 415	
Tavera 2.5D	F 002 H24 400		F 002 H23 415	F 002 H23 412
<b>CITROEN</b>				
C5 Aircross [C84]	F 026 400 433	0 986 628 610	F 026 402 533	F 026 407 268
C5 Aircross [C84]	F 026 400 433	1 987 435 026	F 026 402 533	F 026 407 268
C5 Aircross [C84]	F 026 400 433	1 987 435 522	F 026 402 533	F 026 407 268
<b>DACIA</b>				
Duster [HS]		0 986 628 502		F 026 407 022
Duster [HS]		1 987 435 501		F 026 407 022
Lodgy [JS]	F 026 400 343			
Lodgy [JS] (D) 66 Kw (2012.03 -2018.12)				F 026 407 176
Lodgy [JS] (D) 79 Kw (2012.03 -2018.12)				F 026 407 022
<b>DAEWOO</b>				
Matiz 0.8i	1 987 429 166		0 450 905 316	
<b>FIAT</b>				
500 [312]		1 987 435 005	1 457 070 001	
500 [312]		1 987 435 589	1 457 070 001	
500 [312] (D) 55 Kw (2007.07 -2012.12), Punto '03 [188] (D) 52 Kw (2009.06 -2010.12)				1 457 429 256
500 [312] (D) 55 Kw (2007.07 -2012.12), Punto '03 [188] (D) 52 Kw (2009.06 -2010.12)				F 026 407 067
Linea 1.2 TD			F 026 402 076	
Linea 1.4 i.e. 16V, Linea 1.3 Diesel Classic, Punto 1.2D		1 987 432 072		
Linea [323]		1 987 432 537		1 457 429 256
Linea [323] (P) 88 Kw (2007.03 -2017.12)		1 987 432 188		
Linea [323] (P) 88 Kw (2007.03 -2017.12)		1 987 432 228		
Palio [178] Weekend, Palio [178]			F 026 403 036	0 451 103 354

## Brand wise Filter Application Chart

Model Description	Air Filter	Cabin Filter	Fuel Filter	Oil Filter
Petra 1.9 Ds			1 457 434 293	
Punto '03 [188]		1 987 432 072	1 457 070 001	
Punto 1.4i		1 987 432 072		0 451 103 300
Punto Evo [199]		1 987 432 188	F 026 402 076	F 026 407 096
Punto Evo [199]		1 987 432 537	F 026 402 076	F 026 407 096
Punto Evo [199] (D) 68 Kw (2009.10 -2011.12), Punto Evo [199] (D) 56 Kw (2010.05 -2011.12)	F 026 400 346			
Punto Evo [199] (P) 66 Kw (2009.10 -2011.12), Punto Evo [199] (P) 50 Kw (2010.09 -2011.12)	F 026 400 036			
Siena [178]			1 457 434 106	0 451 103 354
Uno '98 [146]	1 457 433 286			0 451 103 354
<b>FORCE MOTORS</b>				
Challenger 2.4 Diesel, Gurkha 2.6D 4WD, Kargo King 2.6 Diesel, Gurkha 2.4 Turbodiesel 4WD, Judo 2.4 Diesel 4WD, Gama Classic 2.6 Diesel 4WD, Challenger 1.8 Diesel, Gama 2.6 Diesel, Town & Country 2.4 Diesel, Judo 2.4 Diesel, Challenger 2.6 Diesel, Gama Classic 2.6 Diesel			F 002 H26 307	
Cruiser Classic 2.6 Diesel	F 002 H60 012		F 002 H27 407	
Toofan Classic 2.6 Diesel, Trax 2.4D Tempo	F 002 H60 012		F 002 H26 307	
<b>FORD</b>				
EcoSport '14 [JK8]		1 987 432 415		F 026 407 078
Fiesta 1.4 Turbodiesel, Figo 1.4D, Fusion 1.4 Diesel 8V, Fiesta 1.5 Turbodiesel, Figo Aspire 1.5 TDCi, EcoSport 1.5 TD		F 002 H26 399		F 002 H23 487
Fiesta 1.5i, Fiesta 1.6i, Fiesta 1.4i, EcoSport 1.5, Figo Aspire 1.5 Ti-VCT, Figo [B517]		F 002 H26 399		
Freestyle Hatchback				F 002 H23 487
Fusion 1.6i 16V	1 457 433 593	F 002 H26 399		
Mondeo '01 [B4Y]		1 987 432 073		1 457 429 257
Mondeo '01 [B4Y]		1 987 432 073		F 026 407 203
Mondeo III		1 987 432 073		
<b>HINDUSTAN MOTORS LIMITED (HML)</b>				
Ambassador 2000 2.0 Diesel			9 450 030 116	
<b>HONDA</b>				
Amaze First Gen 1.5	F 002 H24 976			F 002 H24 987
City 1.5 i 8V, City 1.5, City 1.5i 16V	F 026 400 223			F 002 H23 467
City 1.5i 16V (P) 87 Kw (2008.09 -2013.12), City [2CT] (P) 66 Kw (1998.01 -2003.10), City 1.5 i 8V (P) 57 Kw (2003.10 -2006.12)				F 026 407 077
City [2CT] (P) 66 Kw (1998.01 -2003.10)				0 986 452 036



### Brand wise Filter Application Chart

Model Description	Air Filter	Cabin Filter	Fuel Filter	Oil Filter
Civic 1.8i, Accord 2.3i 16V, Accord 3.0i, CR-V 2.4i 4WD, City 1.5i 16V VTEC, CR-V 2.0i 4WD, City 1.5i 16V (P) 87 Kw (2008.09 -2013.12), City 1.5i ZX VTEC, CR-V 2.0i, CR-V 2.4 4WD, BR-V 1.5 i-VTEC, Accord 3.5i, Accord 2.4i 16V, City 1.5 i 8V (P) 57 Kw (2003.10 -2006.12), Civic 1.3i 16V				F 002 H23 467
Jazz 1.2	F 026 400 223			
Jazz [2TF]	F 026 400 223	0 986 628 584		F 026 407 077
Jazz [2TF]	F 026 400 223	1 987 432 234		F 026 407 077
Mobilio 1.5 TD				F 002 H24 987
<b>HYUNDAI</b>				
Accent 1.5 CRDi, Getz 1.3 i, Getz 1.1 i		0 986 AF5 529		F 002 H23 490
Accent 1.5 DLS				1 457 429 308
Accent 1.5i 12V			0 450 902 161	
Accent 1.6 i, Sonata 2.0i 16V, Sonata 2.7i, Accent 1.5 CNG				F 002 H23 490
Accent 1.6i 16V			0 450 902 161	0 451 103 316
Accent [LC]			1 457 434 443	F 026 407 332
Creta 1.4 TD	F 002 H26 339	F 002 H24 944	F 002 H26 500	
Creta 1.6	F 002 H26 396	F 002 H24 944		
Creta 1.6 CRDi	F 002 H26 339	F 002 H24 944		
Creta 1.6 CRDi (D) 94 Kw (2015.10 -2021.06)			1 457 434 511	
Elantra 1.6 TD		F 002 H24 944	F 002 H26 500	
Elantra 1.8 i		F 002 H24 944		F 002 H23 490
Elantra 2.0		F 002 H24 944		
Elantra 2.0 CRDi		F 002 H24 944		1 457 429 308
Elantra [MD, UD]		0 986 628 572	F 026 402 813	0 451 103 316
Elantra [MD, UD]		0 986 628 572	F 026 402 813	F 026 407 147
Elite i20 1.4, i20 Active 1.2		F 002 H24 945		
Elite i20 [IB]	F 026 400 558	0 986 628 572		F 026 407 209
Elite i20 [IB]	F 026 400 558	F 002 H24 945		F 026 407 209
Eon 0.8 i	F 002 H24 977			F 002 H20 371
Eon 1.0 Magna Plus		1 987 432 164		F 002 H20 371
Getz 1.5 CRDi 16V		0 986 AF5 529		
Grand i10 1.1 CRDi			1 457 434 511	F 002 H20 371
Grand i10 1.1 TD	F 002 H24 975		F 002 H26 500	
Grand i10 1.2, Xcent 1.2	F 002 H24 981			F 002 H20 371
Santa Fe [DM]			F 026 402 362	F 026 407 156
Santro 1.0i 12V (P+GAS) 46 Kw (2007.07 -2014.11), Santro 1.1 i 12V (P) 46 Kw (2002.03 -2003.07), Santro 1.0i 12V (P) 40 Kw (1998.09 -2002.01)				F 002 H20 371
Santro 1.1 i 12V, Santro 1.0i 12V	F 026 400 273			
Sonata 2.0 CRDi		0 986 AF5 531	F 002 H23 441	

### Brand wise Filter Application Chart

Model Description	Air Filter	Cabin Filter	Fuel Filter	Oil Filter
Sonata [NF] (P) 129 Kw (2009.01 -2011.12), Santa Fe [CM] (D) 110 Kw (2006.03 -2009.11)		0 986 AF5 531		
Sonata [NF] (P) 129 Kw (2009.01 -2011.12), Santa Fe [CM] (D) 110 Kw (2006.03 -2009.11)		0 986 AF5 562		
Sonata [NF], i20 [BC3] (P) 62 Kw (2020.08-->), Sonata [YF]				0 451 103 316
Tucson 2.0 CRDi GLS AT 4WD, Tucson 2.0 Diesel 4WD (D) 82 Kw (2005.04 -2010.01), Creta 1.6 CRDi (D) 94 Kw (2015.10 -2021.06), Verna 1.6 TD, Elantra 2.0 CRDi (D) 83 Kw (2004.04 -2008.12)			F 002 H26 500	
Tucson 2.0 Diesel 4WD (D) 82 Kw (2005.04 -2010.01), Elantra 2.0 CRDi (D) 83 Kw (2004.04 -2008.12)			F 026 402 813	
Verna 1.4 i		F 002 H24 946		
Verna 1.4D, Verna 1.6D	F 002 H24 967	F 002 H24 946	F 002 H26 500	
Verna 1.5 CRDi		F 002 H24 946	F 002 H23 441	F 002 H23 435
Verna 1.6i		F 002 H24 946	F 002 H26 500	F 002 H23 490
Verna 1.6i 16V		F 002 H24 946		F 002 H23 490
Xcent 1.1 TD	F 002 H24 975			
i10 1.1 i	F 002 H23 595	0 986 AF5 541		F 002 H23 470
i10 1.1 i	F 002 H23 595	1 987 432 164		F 002 H23 470
i10 1.2 i 16V	F 002 H26 334			F 002 H23 470
i10 [IA] (P+GAS) 49 Kw (2013.09 -2020.03)				F 002 H23 470
i10 [IA] (P+GAS) 49 Kw (2013.09 -2020.03), Santro 1.1 i 12V (P) 46 Kw (2002.03 -2003.07), Santro 1.0i 12V (P) 40 Kw (1998.09 -2002.01)				F 026 407 209
i10 [IA], Eon LPG 0.8, i10 1.1 CNG		1 987 432 164		
i10 [PA]		1 987 432 164		F 026 407 209
i20 1.2i	F 002 H23 596	1 987 432 132		
i20 1.2i 16V	F 002 H23 596	1 987 432 132		F 002 H23 470
i20 1.4 TD	F 002 H23 596		F 002 H26 500	
i20 [BC3]	F 026 400 558	0 986 628 572		
i20 [BC3] (P) 88 Kw (2020.08-->)				F 026 407 142
i20 [IB] Active, i20 [GB]	F 026 400 558	0 986 628 572	1 457 434 511	F 026 407 147
i20 [PB, PBT]	F 002 H23 596		F 026 402 813	F 026 407 147
<b>ICML</b>				
Rhino 2.0D 4x4 (D) 54 Kw (2006.01 -2007.05), Rhino 2.0D 4x4 (D) 74 Kw (2007.06 -2012.08)			F 002 H26 307	
Rhino 2.0D 4x4 (D) 74 Kw (2007.06 -2012.08)			1 457 434 314	
<b>ISUZU</b>				
D-Max	0 986 AF2 359			F 026 407 304
<b>JAGUAR</b>				
F-Pace [X761] (P) 280 Kw (2015.09 -2020.08), F-Pace [X761] (P) 405 Kw (2020.09-->)	F 026 400 089			F 026 407 269

### Brand wise Filter Application Chart

Model Description	Air Filter	Cabin Filter	Fuel Filter	Oil Filter
F-Pace [X761] (P) 280 Kw (2015.09 -2020.08), F-Pace [X761] (P) 405 Kw (2020.09-->)	F 026 400 699			F 026 407 269
F-Pace [X761] Diesel and electric engine 120 Kw (2020.10-->), F-Pace [X761] (D) 132 Kw (2015.09 -2020.08)	F 026 400 089			F 026 407 275
F-Type Cabriolet [X152], F-Type Coupe [X152], XK [X150] Convertible, XK [X150] Coupe		1 987 435 509		F 026 407 269
XE [X760]	F 026 400 089	1 987 432 190		F 026 407 203
XE [X760], XF Sportbrake [X260]	F 026 400 089	1 987 432 190		F 026 407 275
XF [X250]		1 987 432 568	F 026 402 846	F 026 407 203
XF [X250] (P) 346 Kw (2009.02 -2015.10), XF [X250] (P) 346 Kw (2009.02 -2013.07), XF [X250] (P) 283 Kw (2009.02 -2012.08), XJ [X351] (P) 375 Kw (2010.08 -2019.07), XJ [X351] (P) 283 Kw (2009.11 -2013.10)				F 026 407 269
XF [X260], F-Pace [X761], I-Pace [X590]		1 987 432 190		
XJ [X351]		1 987 432 568		F 026 407 203
XJ [X351] (D) 202 Kw (2010.08 -2015.07), XF [X250] (D) 202 Kw (2009.03 -2015.10)				F 026 407 155
<b>JEEP</b>				
Grand Cherokee [WK2]		1 987 435 079		F 026 407 258
<b>LAND ROVER GROUP</b>				
Evoque [LV,L538], Discovery Sport [LC,L550]	F 026 400 423	0 986 628 561	F 026 402 846	F 026 407 203
Evoque [LV,L538], Discovery Sport [LC,L550]	F 026 400 423	0 986 628 561	F 026 402 846	F 026 407 275
Evoque [LV,L538], Discovery Sport [LC,L550]	F 026 400 423	1 987 432 405	F 026 402 846	F 026 407 203
Evoque [LV,L538], Discovery Sport [LC,L550]	F 026 400 423	1 987 432 405	F 026 402 846	F 026 407 275
Freelander [L359]		0 986 628 561	F 026 402 846	
Freelander [L359]		1 987 432 405	F 026 402 846	
Freelander [LN, L314]			F 026 402 002	1 457 429 119
Freelander [LN, L314]			F 026 402 095	1 457 429 119
Freelander [LN, L314] (D) 140 Kw (2013.03 -2015.09)	1 457 433 588	1 987 432 116		
Freelander [LN, L314] (D) 140 Kw (2013.03 -2015.09)	1 457 433 588	1 987 432 210		
Freelander [LN, L314] (D) 140 Kw (2013.03 -2015.09)	1 457 433 781	1 987 432 116		
Freelander [LN, L314] (D) 140 Kw (2013.03 -2015.09)	1 457 433 781	1 987 432 210		
Range Rover III [LM,L322]		1 987 432 425		
Range Rover III [LM,L322]		1 987 435 117		

### Brand wise Filter Application Chart

Model Description	Air Filter	Cabin Filter	Fuel Filter	Oil Filter
Range Rover IV [LG,L405] (D) 155 Kw (2017.01 -2021.08), Range Rover IV [LG,L405] (D) 183 Kw (2013.02 -2021.08), Discovery IV [LA,L319] (D) 190 Kw (2017.10 -2017.12), Range Rover Sport [LS,L320] (D) 183 Kw (2011.06 -2013.08), Range Rover Sport [LW,L494] (D) 215 Kw (2013.09 -2020.09), Range Rover Sport [LW,L494] (D) 183 Kw (2013.09 -2020.09)				F 026 407 155
Range Rover IV [LG,L405] (P) 375 Kw (2012.11 -2018.04), Range Rover Sport [LS,L320] (P) 372 Kw (2009.09 -2013.08), Range Rover IV [LG,L405] (P) 405 Kw (2015.06 -2017.08), Range Rover III [LM,L322] (P) 375 Kw (2009.09 -2013.01), Range Rover IV [LG,L405] (P) 386 Kw (2017.09 -2020.08), Discovery IV [LA,L319] (P) 180 Kw (2009.07 -2017.12), Range Rover Sport [LW,L494] (P) 375 Kw (2013.10 -2018.04), Range Rover Sport [LW,L494] (P) 280 Kw (2015.06 -2019.09), Range Rover IV [LG,L405] (P) 416 Kw (2017.04 -2020.08)				F 026 407 269
Range Rover IV [LG,L405], Range Rover Sport [LW,L494]		1 987 432 190		
Range Rover Sport [LS,L320] (D) 200 Kw (2006.04 -2009.08), Range Rover III [LM,L322] (D) 200 Kw (2006.09 -2009.08), Range Rover III [LM,L322] (D) 200 Kw (2009.09 -2013.01)				F 026 407 126
<b>LEXUS</b>				
ES [V6]	F 026 400 415	1 987 432 190		
ES [Z]	F 026 400 674	0 986 628 581		F 026 407 306
ES [Z]	F 026 400 674	1 987 435 590		F 026 407 306
LX [J2]	F 026 400 226	1 987 432 190		
NX 300h 4WD		0 986 AF4 431		
RX	F 026 400 456	0 986 628 519		F 026 407 090
RX	F 026 400 456	1 987 432 075		F 026 407 090
<b>MAHINDRA</b>				
BOLERO neo mHawk100, XUV 700 2.2, BOLERO BS6, THAR BS6 4x4			F 002 H26 537	
Bolero 1.5 TD Power+	F 002 H60 012		F 002 H26 514	F 002 H23 439
Bolero 2.5 BS III, Bolero Invader 2.5 Diesel, Bolero 2.5 Diesel 4WD, Bolero 2.5 BS II, Bolero XLS 2.5 Diesel	F 002 H60 012		F 002 H26 625	F 002 H23 439
Bolero 2.5 Diesel	F 002 H23 584		F 002 H21 299	F 002 H23 439
Bolero 2.5 Diesel	F 002 H60 012		F 002 H21 299	F 002 H23 439
Bolero Invader 2.5 Diesel 4WD	F 002 H60 012			F 002 H23 439
Bolero XL 2.5 Diesel, Maxx 2.5 Diesel Pik-Up (2005)	F 002 H60 012		F 002 H24 496	F 002 H23 439
CL 500/550 DI 2.5 Diesel 4WD, CL 500/550 MDI 2.5 Diesel, CL 500/550 MDI 2.5 Diesel 4WD, Major 2.5 Diesel 4WD, Commander 650 2.5 Diesel, Maxx 2.5 Diesel 4WD, CL 500/550 2.5 Diesel			9 451 037 404	

### Brand wise Filter Application Chart

Model Description	Air Filter	Cabin Filter	Fuel Filter	Oil Filter
CL 500/550 DI 2.5 Diesel 4WD, CL 500/550 MDI 2.5 Diesel, CL 500/550 MDI 2.5 Diesel 4WD, Major 2.5 Diesel 4WD, Commander 650 2.5 Diesel, Maxx 2.5 Diesel 4WD, CL 500/550 2.5 Diesel			9 451 037 405	
KUV100 1.2			F 002 H26 625	F 002 H26 539
KUV100 1.2, Scorpio 2.0, Scorpio 2.0i			F 002 H26 625	F 002 H23 439
Logan 1.4i			0 450 902 161	F 002 H23 551
Logan 1.5 Diesel				F 002 H23 551
MARAZZO 1.5 BS6			F 002 H26 537	F 002 H26 539
MM 440 2.2				F 002 H20 215
MM 540/550 DP 2.1 Diesel 4WD, MM 2.1i 4WD, MM 540/550 XDB 2.5 Diesel, MM 540/550 DP 2.1 Diesel, Armada Grand 2.5 Diesel, MM 540 XDB 4x4, CL 340 DP 2.1 Diesel 4WD, Armada 2.1 Diesel, MM 540/550 XDB 2.5 Diesel 4WD				9 451 037 446
Major 2.5 Diesel	F 002 H60 012		9 451 037 404	F 002 H20 244
Major 2.5 Diesel	F 002 H60 012		9 451 037 405	F 002 H20 244
Marazzo 1.5			F 002 H24 496	F 002 H23 439
Marshal 2.1 Diesel			F 002 H26 307	9 451 037 446
Marshal 2.5 Diesel 4WD	F 002 H60 012		9 451 037 404	
Marshal 2.5 Diesel 4WD	F 002 H60 012		9 451 037 405	
Marshal 2.5 Diesel 4WD	F 002 H60 012		F 002 H24 496	
Marshal 2.5 Diesel 4WD	F 002 H60 012		F 002 H26 307	
Marshal 2.5 Diesel, Bolero Invader 2.5 Diesel, Bolero Invader GLX 2.5 Diesel, Bolero Invader GLX 2.5 Diesel 4WD, Bolero 2.5 Diesel 4WD, Bolero 2.5 BS II	F 002 H60 012		F 002 H26 307	F 002 H23 439
Marshal 2.5 Diesel, Maxx 2.5 Diesel	F 002 H60 012		9 451 037 404	F 002 H23 439
Marshal 2.5 Diesel, Maxx 2.5 Diesel	F 002 H60 012		9 451 037 405	F 002 H23 439
NuvoSport 1.5TD, TUV 300 Plus 2.2, Scorpio 2.2 mHawk140 CRDe 4WD			F 002 H26 514	
Quanto 1.5D		1 987 432 057	F 002 H26 625	F 002 H26 539
Quanto 1.5D, Scorpio 1.9TD 4x4, Scorpio 2.2TD 4x4		1 987 432 057	F 002 H26 625	F 002 H23 439
Scorpio 2.2 TD	F 002 H23 584		F 002 H20 152	F 002 H23 439
Scorpio 2.2 TD	F 002 H23 584		F 002 H26 514	F 002 H23 439
Scorpio 2.2 TD 4WD		1 987 432 057	F 002 H20 152	F 002 H23 439
Scorpio 2.2 TD 4WD		1 987 432 057	F 002 H26 514	F 002 H23 439
Scorpio 2.2 TD 4x4			1 457 434 314	F 002 H23 439

### Brand wise Filter Application Chart

Model Description	Air Filter	Cabin Filter	Fuel Filter	Oil Filter
Scorpio 2.2 mHawk140 CRDe 4WD (D) 103 Kw (2017.11-->), KUV100 1.2 TD (D) 57 Kw (2016.01-->), XUV500 2.2D (D) 103 Kw (2011.09 -2018.04), XUV500 2.2D 4x4 (D) 103 Kw (2011.09 -2018.04), Scorpio 2.2 mHawk140 CRDe 2WD (D) 103 Kw (2017.11-->), TUV300 1.5 TD (D) 62 Kw (2015.09-->), TUV 300 Plus 2.2 (D) 88 Kw (2018.05-->), Scorpio 2.5D (D) 55 Kw (2015.01-->), NuvoSport 1.5TD (D) 74 Kw (2016.04-->), TUV300 T10 1.5 mHawk100 (D) 74 Kw (2015.09-->), Bolero 1.5 TD Power+ (D) 51 Kw (2016.09-->), Scorpio 2.2 TD (D) 88 Kw (2015.01-->), TUV300 1.5 TD Auto (D) 59 Kw (2015.09-->), XUV500 2.2 W9 (D) 103 Kw (2017.12-->), Scorpio 2.2 TD 4WD (D) 88 Kw (2015.01-->), Scorpio 2.2 mHawk140 CRDe 4WD, Scorpio 2.2 TD (D) 87 Kw (2007.11 -2014.12), Bolero 2.5 Diesel (D) 46 Kw (2011.11-->)			F 002 H20 152	
Scorpio 2.2 mHawk140 CRDe 4WD (D) 103 Kw (2017.11-->), XYLO 2.2 TD mHawk (D) 91 Kw (2013.05-->), KUV100 1.2 TD (D) 57 Kw (2016.01-->), XUV500 2.2D (D) 103 Kw (2011.09 -2018.04), XUV500 2.2D 4x4 (D) 103 Kw (2011.09 -2018.04), CL 500/550 2.5 Diesel, Scorpio 2.2 mHawk140 CRDe 2WD (D) 103 Kw (2017.11-->), TUV300 1.5 TD (D) 62 Kw (2015.09-->), TUV 300 Plus 2.2 (D) 88 Kw (2018.05-->), Scorpio 2.5D (D) 55 Kw (2015.01-->), NuvoSport 1.5TD (D) 74 Kw (2016.04-->), XUV300 1.2, TUV300 T10 1.5 mHawk100 (D) 74 Kw (2015.09-->), Bolero Invader 2.5 Diesel 4WD (D) 51 Kw (2004.12 -2006.10), Bolero 2.5 Diesel (D) 53 Kw (2000.08 -2005.04), Bolero 1.5 TD Power+ (D) 51 Kw (2016.09-->), Scorpio 2.2 TD (D) 88 Kw (2015.01-->), TUV300 1.5 TD Auto (D) 59 Kw (2015.09-->), XUV500 2.2 W9 (D) 103 Kw (2017.12-->), Scorpio 2.2 TD 4WD (D) 88 Kw (2015.01-->)			F 002 H26 625	
Scorpio 2.5D	F 002 H60 012	1 987 432 057	F 002 H20 152	F 002 H26 539
Scorpio 2.5D	F 002 H60 012	1 987 432 057	F 002 H26 514	F 002 H23 439
Scorpio 2.5D	F 002 H60 012	1 987 432 057	F 002 H26 514	F 002 H26 539
Scorpio 2.6 CRDe (D) 85 Kw (2005.02 -2009.06), Bolero 2.5 Diesel (D) 53 Kw (2000.08 -2005.04), XUV500 2.2D (D) 103 Kw (2011.09 -2018.04), Quanto 1.5D (D) 74 Kw (2012.09 -2016.04), Commander 2.5 Diesel, XUV500 2.2D 4x4 (D) 103 Kw (2011.09 -2018.04), Scorpio 2.5D (D) 52 Kw (2007.10 -2014.10), Scorpio 2.6 Diesel Turbo 4x4 (D) 85 Kw (2007.06 -2019.06), XYLO 2.5 TD MDI (D) 68 Kw (2009.01 -2012.02), Commander 2.1D 4WD Hard Top, Commander 2.1D Hard Top, Bolero XLS 2.5 Diesel (D) 44.5 Kw (2004.02 -2005.12), Scorpio 2.2 TD (D) 87 Kw (2007.11 -2014.12)			F 002 H26 307	



## Brand wise Filter Application Chart

Model Description	Air Filter	Cabin Filter	Fuel Filter	Oil Filter
Scorpio 2.6 CRDe (D) 85 Kw (2005.02 -2009.06), XUV500 2.2D (D) 103 Kw (2011.09 -2018.04), Quanto 1.5D (D) 74 Kw (2012.09 -2016.04), XUV500 2.2D 4x4 (D) 103 Kw (2011.09 -2018.04), Scorpio 2.5D (D) 52 Kw (2007.10 -2014.10), Scorpio 2.6 Diesel Turbo 4x4 (D) 85 Kw (2007.06 -2019.06), XYLO 2.5 TD MDI (D) 68 Kw (2009.01 -2012.02), Scorpio 2.2 TD (D) 87 Kw (2007.11 -2014.12)			1 457 434 314	
Scorpio 2.6 CRDe, Scorpio 2.5D	F 002 H60 012	1 987 432 057	F 002 H20 152	F 002 H23 439
Scorpio 2.6 Diesel Turbo (D) 80 Kw (2002.06 -2006.03)	F 002 H60 012		9 450 030 116	
Scorpio 2.6 Diesel Turbo (D) 80 Kw (2002.06 -2006.03)	F 002 H60 012		F 002 H21 229	
Scorpio 2.6 Diesel Turbo (D) 85 Kw (2007.06 -2009.06)	F 002 H23 584		1 457 434 314	
Scorpio 2.6 Diesel Turbo (D) 85 Kw (2007.06 -2009.06)	F 002 H23 584		F 002 H21 229	
Scorpio 2.6 Diesel Turbo (D) 85 Kw (2007.06 -2009.06)	F 002 H23 584		F 002 H26 307	
Scorpio 2.6 Diesel Turbo 4WD	F 002 H60 012		F 002 H20 152	F 002 H23 439
Scorpio 2.6 Diesel Turbo 4WD (D) 80 Kw (2002.06 -2006.03), Bolero 2.5 Diesel (D) 53 Kw (2000.08 -2005.04), Bolero XLS 2.5 Diesel (D) 44.5 Kw (2004.02 -2005.12)			9 450 030 116	
Scorpio 2.6 Diesel Turbo 4WD (D) 80 Kw (2002.06 -2006.03), Scorpio 2.6 CRDe (D) 85 Kw (2005.02 -2009.06), Scorpio 2.6 Diesel Turbo 4x4 (D) 85 Kw (2007.06 -2019.06)			F 002 H21 229	
Scorpio 2.6 Diesel Turbo, Scorpio 2.6 Diesel Turbo 4x4, Scorpio 2.2 mHawk140 CRDe 2WD, XUV300 1.5			F 002 H20 152	F 002 H23 439
Scorpio SUV 2.2 CRDe, KUV100 1.2 D75				F 002 H26 539
TUV300 T10 1.5 mHawk100, KUV100 1.2 TD, Scorpio 2.2 mHawk140 CRDe 2WD, TUV300 1.5 TD Auto, TUV300 1.5 TD			F 002 H26 514	F 002 H23 439
Thar 2.5D 4x4 (D) 47 Kw (2010.12 -2013.04), Thar 2.5 TD	F 002 H23 584		F 002 H24 496	
Thar 2.5D 4x4 (D) 77 Kw (2010.12 -2013.04)	F 002 H60 012		F 002 H26 625	
Thar 2.5D 4x4, Commander 655 2.5 Diesel 4WD				F 002 H23 439
XUV 500 BS6, Scorpio			F 002 H26 538	
XUV500 1.9TD		F 002 H24 984	F 002 H26 625	F 002 H23 439
XUV500 2.2D, XUV500 2.2 W9, XUV500 2.2D 4x4	F 002 H23 586	F 002 H24 984	F 002 H26 514	F 002 H23 439
XYLO	F 002 H23 585		F 002 H24 496	F 002 H23 439
XYLO 2.2 TD mHawk	F 002 H23 585	1 987 432 057		F 002 H23 439
XYLO 2.2 TD mHawk (D) 91 Kw (2013.05-->), Bolero Invader 2.5 Diesel 4WD (D) 40 Kw (2003.03 -2004.10), Bolero 2.5 Diesel (D) 47 Kw (2007.03 -2011.09), Bolero 2.5 Diesel (D) 46 Kw (2011.11-->)			F 002 H24 496	
XYLO 2.5 TD MDI, XYLO 2.5 TD mEagle	F 002 H23 585	1 987 432 057	F 002 H26 625	F 002 H23 439

## Brand wise Filter Application Chart

Model Description	Air Filter	Cabin Filter	Fuel Filter	Oil Filter
XYLO 2.5 TD mEagle	F 002 H23 585	1 987 432 057	F 002 H22 012	F 002 H23 439
<b>MARUTI</b>				
800 0.8i 12V			F 002 H23 423	F 002 H20 377
A-Star 1.0i 12V	F 002 H23 427	F 002 H24 938	F 002 H26 307	F 002 H23 550
Alto 0.8i 12V (P) 33 Kw (2000.09 -2006.01), Baleno 1.6i (P) 67 Kw (2005.10 -2007.04), Celerio 1.0 VXi Green CNG (P+GAS) 43 Kw (2014.05-->)				F 002 H23 550
Alto 0.8i 12V, Alto 0.8i	F 002 H20 378		F 002 H23 423	F 002 H23 550
Alto 0.8i 12V, Alto 0.8i	F 002 H20 378		F 002 H26 307	F 002 H23 550
Alto 1.0 CNG/LPG	F 002 H24 979	F 002 H24 938		F 002 H23 523
Alto 1.0i	F 002 H24 979	F 002 H24 938	F 002 H23 423	F 002 H23 523
Alto 1.0i	F 002 H24 979	F 002 H24 938	F 002 H26 307	F 002 H23 523
Alto 1.1i 16V	F 002 H20 378		F 002 H23 423	F 002 H20 377
Alto 1.1i 16V	F 002 H20 378		F 002 H26 307	F 002 H20 377
Alto 800	F 002 H24 978		F 002 H23 423	F 002 H23 550
Alto 800	F 002 H24 978		F 002 H26 307	F 002 H23 550
Alto 800 CNG	F 002 H24 978		F 002 H23 423	F 002 H20 377
Baleno 1.2	F 002 H26 332	F 002 H24 939	1 457 070 001	F 002 H23 550
Baleno 1.2 (P) 62 Kw (2015.10-->), Baleno 1.6i (P) 69 Kw (1999.11 -2005.10), Ertiga 1.5 Smart Hybrid Generation II, 800 0.8 i 6V, Alto 0.8i 12V (P) 35 Kw (2006.02 -2012.10), Celerio X 1.0 2WD				F 002 H20 377
Baleno 1.6i, Baleno Altura 1.6i	1 457 433 953			F 002 H20 377
Celerio 1.0	F 002 H24 979			F 002 H23 550
Celerio 1.0 VXi Green CNG	F 002 H23 426	F 002 H24 939	1 457 070 001	F 002 H23 550
Ciaz 1.4 Generation I	F 002 H23 427	F 002 H24 940		F 002 H23 550
Dzire 1.2	F 002 H23 426	F 002 H24 939	F 002 H23 421	F 002 H23 432
Dzire 1.2	F 002 H23 426	F 002 H24 939	F 002 H23 421	F 002 H23 550
Dzire BS IV	F 002 H26 540	F 002 H24 939	1 457 070 001	F 002 H20 377
Eeco 1.2i	F 002 H26 329			F 002 H23 550
Ertiga 1.3 TD Generation I, Ciaz 1.3 TD	F 002 H23 426	F 002 H24 939	1 457 070 001	F 002 H23 432
Ertiga 1.4 CNG Generation I, Ertiga 1.4 Generation I	F 002 H23 427	F 002 H24 939		F 002 H23 550
Esteem 1.3i, 1000 1.0i 8V, 800 LPG				F 002 H24 311
Gypsy 1.3 4WD, Gypsy 1.3i 4WD	1 987 429 125			F 002 H24 311
Ignis 1.2		F 002 H24 942		F 002 H20 377
Ignis 1.3 TD		F 002 H24 942	1 457 070 001	
Omni 0.8 Generation I, Omni 0.8 LPG Generation II, Gypsy 1.0 4WD, Omni 0.8 Generation II	9 951 030 131			F 002 H24 311
Ritz 1.2 Generation I		1 987 432 214	F 002 H23 421	F 002 H23 550
Ritz 1.2 Generation I (D) 55 Kw (2009.05 -2012.07)	F 002 H23 426		1 457 434 314	F 002 H23 432
Ritz 1.2 Generation I (D) 55 Kw (2009.05 -2012.07)	F 002 H23 426		F 002 H21 249	F 002 H23 432
Ritz 1.2 Generation I (D) 55 Kw (2009.05 -2012.07)	F 002 H23 426		F 002 H26 307	F 002 H23 432

### Brand wise Filter Application Chart

Model Description	Air Filter	Cabin Filter	Fuel Filter	Oil Filter
Ritz 1.2 Generation I (P) 63 Kw (2009.05 -2012.07)	F 002 H23 427			F 002 H23 550
S-cross 1.2			F 002 H24 990	F 002 H23 432
S-cross 1.2 (D) 66 Kw (2015.08-->), S-cross 1.6 TD 2WD		F 002 H24 940		
S-cross 1.2 (D) 66 Kw (2015.08-->), SX4 1.6i, Dzire Tour S CNG 1.2		F 002 H24 939		
SX4 1.3D, Baleno 1.2 (D) 55 Kw (2015.10-->), Celerio 1.0 VXi Green CNG (P+GAS) 43 Kw (2014.05-->)				F 002 H23 432
Swift 1.2, Swift 1.2i, Swift 1.2i Dzire	F 002 H23 427	F 002 H24 939	F 002 H23 421	F 002 H23 550
Swift 1.3 Dzire TD	F 002 H23 426	F 002 H24 939		F 002 H23 432
Swift 1.3 Dzire TD (D) 56 Kw (2008.03 -2012.02)			1 457 434 314	
Swift 1.3 Dzire TD (D) 56 Kw (2008.03 -2012.02)			F 002 H26 625	
Swift 1.3 Dzire TD (D) 56 Kw (2008.03 -2012.02), Swift 1.3 Dzire TD (D) 56 Kw (2012.02-->)			F 002 H26 307	
Swift 1.3 Dzire TD (D) 56 Kw (2012.02-->)			1 457 070 001	
Swift 1.3 TD		F 002 H24 939	F 002 H21 249	F 002 H23 432
Swift 1.3 TD (D) 55 Kw (2011.08-->)	F 002 H23 426		1 457 070 001	
Swift 1.3 TD (D) 55 Kw (2011.08-->)	F 002 H23 426		F 002 H21 249	
Swift 1.3 TD (D) 55 Kw (2011.08-->), Swift 1.3 TD (D) 56 Kw (2007.01 -2011.07)	F 002 H23 426		F 002 H26 307	
Swift 1.3 TD (D) 56 Kw (2007.01 -2011.07)	F 002 H23 426		1 457 434 314	
Swift 1.3 TD (D) 56 Kw (2007.01 -2011.07)	F 002 H23 426		F 002 H26 625	
Swift 1.3 TD (D) 56 Kw (2007.01 -2011.07)	F 002 H23 427		1 457 434 314	
Swift 1.3 TD (D) 56 Kw (2007.01 -2011.07)	F 002 H23 427		F 002 H26 307	
Swift 1.3 TD (D) 56 Kw (2007.01 -2011.07)	F 002 H23 427		F 002 H26 625	
Swift 1.3i	F 002 H23 427		F 002 H23 421	F 002 H20 377
Swift 1.3i Dzire	F 002 H23 427		F 002 H23 421	F 002 H23 550
Swift BS IV		F 002 H24 939	1 457 070 001	F 002 H20 377
Tour S 1.2	F 002 H26 540			
Versa 1.3i 16V	F 002 H26 329			F 002 H20 377
Vitara Brezza 1.2	F 002 H24 982	F 002 H24 940		F 002 H23 432
Wagon R 1.0	F 002 H27 540		F 002 H23 423	F 002 H23 523
Wagon R 1.0, Zen 1.0i Estilo CNG, Zen 1.0i Estilo	F 002 H27 540		F 002 H26 307	F 002 H23 523
Wagon R 1.0i LPG	F 002 H27 540	F 002 H24 943	F 002 H26 307	F 002 H23 523
Wagon R 1.1i 16V	F 002 H20 378	F 002 H24 943	F 002 H23 423	F 002 H20 377
Zen 1.0i 16V	9 951 030 130			F 002 H20 377
Zen 1.0i, 800 0.8i 6V	9 951 030 130			F 002 H24 311
Zen 1.1 Estilo			F 002 H23 423	F 002 H24 311
Zen 1.1 Estilo			F 002 H26 307	F 002 H24 311
<b>MERCEDES-BENZ</b>				
124-Serie [124]		1 987 432 081		1 457 429 122

### Brand wise Filter Application Chart

Model Description	Air Filter	Cabin Filter	Fuel Filter	Oil Filter
A-Klasse [177]	F 026 400 600	1 987 435 143	F 026 402 262	
A-Klasse [177]	F 026 400 600	1 987 435 609	F 026 402 262	
A-Klasse [177] Limousine, GLA-Klasse [247]	F 026 400 593	1 987 435 143		F 026 407 231
A-Klasse [177] Limousine, GLA-Klasse [247]	F 026 400 593	1 987 435 609		F 026 407 231
C 220 CDI		1 987 432 070		
C 220 CDI (D) 125 Kw (2015.02-->), C-Klasse [205] (D) 150 Kw (2016.03-->), GLC-Klasse [253] (D) 120 Kw (2015.07 -2019.03)				F 026 407 112
C-Klasse [203]				F 00E 369 874
C-Klasse [203] (D) 100 Kw (2004.01 -2007.12), C-Klasse [203] (D) 75 Kw (2000.07 -2003.06)	1 457 433 065			1 457 437 001
C-Klasse [203] (P) 120 Kw (2002.05 -2007.02), SLK-Klasse [171] (P) 135 Kw (2007.12 -2010.11), SLK-Klasse [171] (P+GAS) 120 Kw (2004.04 -2007.11)	1 987 429 401			1 457 429 261
C-Klasse [203] (P) 95 Kw (2000.10 -2002.08)	1 457 433 043			1 457 429 122
C-Klasse [204] (D) 150 Kw (2008.09 -2014.12), C-Klasse [204] (D) 125 Kw (2012.10 -2014.12)			F 026 402 103	F 026 407 112
C-Klasse [204] (D) 150 Kw (2008.09 -2014.12), C-Klasse [204] (D) 125 Kw (2012.10 -2014.12)			F 026 402 839	F 026 407 112
C-Klasse [204] (P) 135 Kw (2009.04 -2014.12)				F 026 407 132
C-Klasse [204], AMG GT [190] Roadster		0 986 628 600		
C-Klasse [204], AMG GT [190] Roadster		1 987 435 001		
C-Klasse [205]		0 986 628 567	F 026 402 262	
C-Klasse [205]		1 987 435 058	F 026 402 262	
C-Klasse [205]		1 987 435 601	F 026 402 262	
C-Klasse [205] (D) 110 Kw (2018.10-->), GLC-Klasse [253] (D) 180 Kw (2019.04 -2022.05), G-Klasse [463] (D) 210 Kw (2019.01-->)	F 026 400 468			F 026 407 238
C-Klasse [205] (P) 135 Kw (2013.12 -2019.02), GLC-Klasse [253] (P) 180 Kw (2016.05 -2019.03), E-Klasse [212] (P) 135 Kw (2012.08 -2016.08)	F 026 400 480			
C-Klasse [205], GLC-Klasse [253]		0 986 628 567	F 026 402 839	
C-Klasse [205], GLC-Klasse [253]		1 987 435 058	F 026 402 839	
C-Klasse [205], GLC-Klasse [253]		1 987 435 601	F 026 402 839	
CL-Klasse [216]	1 457 433 071	1 987 432 438		F 00E 369 874
CL-Klasse [216] (P) 285 Kw (2006.06 -2010.07), E-Klasse [210] (P) 125 Kw (1997.09 -2000.04)				1 457 429 263
CLA-Klasse [117], A-Klasse [176]	F 026 400 379	1 987 435 505		F 026 407 112
CLS-Klasse [218] Coupe	F 026 400 712	0 986 628 600		
CLS-Klasse [218] Coupe	F 026 400 712	1 987 435 001		
CLS-Klasse [218] SB		0 986 628 600	F 026 402 839	F 026 407 112
CLS-Klasse [218] SB		1 987 435 001	F 026 402 839	F 026 407 112
CLS-Klasse [219]		1 987 432 081	1 457 434 437	1 457 429 263
CLS-Klasse [219]		1 987 432 081	1 457 434 437	F 00E 369 874

## Brand wise Filter Application Chart

Model Description	Air Filter	Cabin Filter	Fuel Filter	Oil Filter
CLS-Klasse [219] (P) 285 Kw (2006.04 -2011.08), M-Klasse [164] (P) 200 Kw (2005.09 -2011.06), CLS-Klasse [219] (P) 200 Kw (2004.06 -2009.12), R-Klasse [251] (P) 200 Kw (2005.09 -2012.10), SLK-Klasse [171] (P) 265 Kw (2004.04 -2010.11)	1 457 433 071			
E-Klasse [124]		1 987 432 051		1 457 429 274
E-Klasse [207] Cabrio, E-Klasse [207] Coupe	1 457 433 071	0 986 628 600		1 457 429 263
E-Klasse [207] Cabrio, E-Klasse [207] Coupe	1 457 433 071	0 986 628 600		F 00E 369 874
E-Klasse [207] Cabrio, E-Klasse [207] Coupe	1 457 433 071	1 987 435 001		1 457 429 263
E-Klasse [207] Cabrio, E-Klasse [207] Coupe	1 457 433 071	1 987 435 001		F 00E 369 874
E-Klasse [210]	1 457 433 065		0 450 905 030	
E-Klasse [210] (P) 100 Kw (1998.01 -2000.02), E-Klasse [210] (P) 110 Kw (1995.06 -1997.08)				1 457 429 122
E-Klasse [211]		1 987 435 053	1 457 434 437	
E-Klasse [211] (D) 110 Kw (2002.03 -2006.03), C 220 CDI (D) 125 Kw (2010.11 -2011.12), E-Klasse [210] (D) 100 Kw (1999.08 -2002.03), E-Klasse [211] (D) 120 Kw (2002.03 -2005.03)				1 457 437 001
E-Klasse [211] (D) 140 Kw (2005.09 -2008.12), E-Klasse [211] (D) 145 Kw (2006.01 -2009.08), CLS-Klasse [219] (D) 155 Kw (2005.05 -2009.04)	F 026 400 388			
E-Klasse [211] (D) 140 Kw (2005.09 -2008.12), E-Klasse [211] (D) 145 Kw (2006.01 -2009.08), CLS-Klasse [219] (D) 155 Kw (2005.05 -2009.04)	F 026 400 389			
E-Klasse [212]		0 986 628 600		F 026 407 112
E-Klasse [212]		1 987 435 001		F 026 407 112
E-Klasse [212] (D) 150 Kw (2008.12 -2016.08), E-Klasse [212] (D) 170 Kw (2008.08 -2010.11), E-Klasse [212] (D) 120 Kw (2008.12 -2014.12)			F 026 402 103	
E-Klasse [212] (D) 170 Kw (2008.08 -2010.11), E-Klasse [212] (D) 195 Kw (2010.12 -2013.12), GLE-Klasse [166] (D) 190 Kw (2015.04 -2018.10), R-Klasse [251] (D) 195 Kw (2010.05 -2012.10), M-Klasse [166] (D) 190 Kw (2011.06 -2015.08)			F 026 402 836	
E-Klasse [212] (P) 410 Kw (2011.04 -2015.08)	F 026 400 712			
E-Klasse [213]	F 026 400 468	0 986 628 567	F 026 402 262	F 026 407 238
E-Klasse [213]	F 026 400 468	0 986 628 567	F 026 402 836	F 026 407 238
E-Klasse [213]	F 026 400 468	1 987 435 058	F 026 402 262	F 026 407 238
E-Klasse [213]	F 026 400 468	1 987 435 058	F 026 402 836	F 026 407 238
E-Klasse [213]	F 026 400 468	1 987 435 601	F 026 402 262	F 026 407 238
E-Klasse [213]	F 026 400 468	1 987 435 601	F 026 402 836	F 026 407 238
EQC-Klasse [293]		0 986 628 567		
EQC-Klasse [293]		1 987 435 058		
EQC-Klasse [293]		1 987 435 601		
G-Klasse [463]			0 450 905 275	F 00E 369 874
G-Klasse [463]			F 026 402 261	F 00E 369 874

## Brand wise Filter Application Chart

Model Description	Air Filter	Cabin Filter	Fuel Filter	Oil Filter
G-Klasse [463] (P) 350 Kw (2004.04 -2011.08)	F 026 400 155			1 457 429 263
GL-Klasse [164]		0 986 628 560		
GL-Klasse [164]		1 987 435 585		
GLA-Klasse [156], B-Klasse [246]	F 026 400 379	1 987 435 505	F 026 402 836	F 026 407 112
GLC-Klasse [253]		0 986 628 567	F 026 402 261	
GLC-Klasse [253]		1 987 435 058	F 026 402 261	
GLC-Klasse [253]		1 987 435 601	F 026 402 261	
GLC-Klasse [253] Coupe		0 986 628 567	F 026 402 839	F 026 407 112
GLC-Klasse [253] Coupe		1 987 435 058	F 026 402 839	F 026 407 112
GLC-Klasse [253] Coupe		1 987 435 601	F 026 402 839	F 026 407 112
GLE-Klasse [166]		1 987 435 058		F 026 407 112
GLE-Klasse [166]		1 987 435 618		F 026 407 112
GLE-Klasse [167]	F 026 400 468	1 987 435 163	F 026 402 261	F 026 407 238
GLE-Klasse [167]	F 026 400 468	1 987 435 617	F 026 402 261	F 026 407 238
GLS-Klasse [166], GL-Klasse [166]	F 026 400 712	1 987 435 058	F 026 402 836	
GLS-Klasse [166], GL-Klasse [166]	F 026 400 712	1 987 435 618	F 026 402 836	
GLS-Klasse [167]	F 026 400 468	1 987 435 163		
GLS-Klasse [167]	F 026 400 468	1 987 435 617		
M-Klasse [164], R-Klasse [251]		0 986 628 560		1 457 429 263
M-Klasse [164], R-Klasse [251]		0 986 628 560		F 00E 369 874
M-Klasse [164], R-Klasse [251]		1 987 435 585		1 457 429 263
M-Klasse [164], R-Klasse [251]		1 987 435 585		F 00E 369 874
M-Klasse [166]	F 026 400 712	1 987 435 618		F 026 407 112
M-Klasse [166] (D) 150 Kw (2011.06 -2015.08), E-Klasse [212] (D) 150 Kw (2008.12 -2016.08), E-Klasse [212] (D) 120 Kw (2008.12 -2014.12), GLE-Klasse [166] (D) 150 Kw (2015.04 -2018.10)			F 026 402 839	
S-Klasse [217] Coupe, S-Klasse [217] Cabrio	F 026 400 712	1 987 435 546		
S-Klasse [221]		1 987 432 438		
S-Klasse [221] (D) 173 Kw (2005.12 -2009.04), R-Klasse [251] (D) 140 Kw (2009.05 -2010.05), S-Klasse [221] (D) 173 Kw (2009.05 -2013.12), GL-Klasse [164] (D) 165 Kw (2009.05 -2010.08), M-Klasse [164] (D) 140 Kw (2009.05 -2010.12)	F 026 400 388		1 457 434 437	
S-Klasse [221] (D) 173 Kw (2005.12 -2009.04), R-Klasse [251] (D) 140 Kw (2009.05 -2010.05), S-Klasse [221] (D) 173 Kw (2009.05 -2013.12), GL-Klasse [164] (D) 165 Kw (2009.05 -2010.08), M-Klasse [164] (D) 140 Kw (2009.05 -2010.12)	F 026 400 388		F 026 402 103	
S-Klasse [221] (D) 173 Kw (2005.12 -2009.04), R-Klasse [251] (D) 140 Kw (2009.05 -2010.05), S-Klasse [221] (D) 173 Kw (2009.05 -2013.12), GL-Klasse [164] (D) 165 Kw (2009.05 -2010.08), M-Klasse [164] (D) 140 Kw (2009.05 -2010.12)	F 026 400 389		1 457 434 437	



## Brand wise Filter Application Chart

Model Description	Air Filter	Cabin Filter	Fuel Filter	Oil Filter
S-Klasse [221] (D) 173 Kw (2005.12 -2009.04), R-Klasse [251] (D) 140 Kw (2009.05 -2010.05), S-Klasse [221] (D) 173 Kw (2009.05 -2013.12), GL-Klasse [164] (D) 165 Kw (2009.05 -2010.08), M-Klasse [164] (D) 140 Kw (2009.05 -2010.12)	F 026 400 389		F 026 402 103	
S-Klasse [221] (P) 170 Kw (2005.09 -2009.12), G-Klasse [463] (P) 350 Kw (2004.04 -2011.08), SLK-Klasse [171] (P) 200 Kw (2004.04 -2008.12), E-Klasse [211] (P) 130 Kw (2002.03 -2006.06), S-Klasse [220], C-Klasse [203] (P) 270 Kw (2004.02 -2007.08), E-Klasse [211] (P) 170 Kw (2006.01 -2009.03), S-Klasse [221] (P) 200 Kw (2009.01 -2012.12), CLK-Klasse [209] Cabrio, E-Klasse [211] (P) 150 Kw (2007.09 -2009.03)	1 457 433 071			1 457 429 263
S-Klasse [221] (P) 386 Kw (2006.12 -2010.07), C-Klasse [204] (P) 336 Kw (2008.02 -2014.12), CL-Klasse [216] (P) 386 Kw (2007.01 -2010.07)				F 026 407 341
S-Klasse [222]	F 026 400 712	1 987 435 546	F 026 402 836	F 026 407 319
S-Klasse [222] Maybach		1 987 435 546		
S-Klasse [222] Maybach (P) 345 Kw (2017.07 -2020.09)				F 026 407 345
S-Klasse [222] Maybach (P) 390 Kw (2014.12 -2017.06), S-Klasse [221] (P) 380 Kw (2005.12 -2013.06), S-Klasse [222] Maybach (P) 463 Kw (2017.07 -2020.09), CL-Klasse [216] (P) 380 Kw (2006.09 -2014.12)				F 026 407 319
S-Klasse [223]	F 026 400 468		F 026 402 261	F 026 407 238
SL-Klasse [230]	1 457 433 071	1 987 435 508		1 457 429 263
SL-Klasse [230]	1 457 433 071	1 987 435 508		F 00E 369 874
SLC-Klasse [172]		1 987 432 571		
SLK-Klasse [172]		1 987 432 571		0 986 MF2 356
SLK-Klasse [172], SLK-Klasse [171]		1 987 432 571		F 00E 369 874
SLS-Klasse [197] Coupe		0 986 628 600		F 026 407 341
SLS-Klasse [197] Coupe		1 987 435 001		F 026 407 341
<b>MITSUBISHI</b>				
Lancer 2.0 Diesel			1 457 434 435	
<b>NISSAN</b>				
370 Z [Z34] Coupe	F 026 400 130			F 026 407 209
Micra 1.2 i	F 026 400 222	1 987 432 246		
Micra [K13K]		1 987 432 246	0 450 907 013	
Micra [K13K] (D) 47 Kw (2010.11-->)	F 026 400 051			F 026 407 022
Micra [K13K] (P) 59 Kw (2010.05 -2015.10)	F 026 400 222			F 026 407 209
Sunny 1.5D		1 987 432 246		
Teana 2.5i				F 026 407 209
Terrano 1.6, Terrano 1.5 D		F 002 H24 948		
X-Trail [T30]		1 987 435 517		0 986 452 003
X-Trail [T30]		1 987 435 592		0 986 452 003

## Brand wise Filter Application Chart

Model Description	Air Filter	Cabin Filter	Fuel Filter	Oil Filter
X-Trail [T31]	F 026 400 126			F 026 407 014
<b>OPEL</b>				
Astra F [T92]			0 450 905 280	0 451 103 370
Corsa 1.4i Swing Hatchback				0 451 103 079
Corsa 1.6i Sail Hatchback, Corsa 1.4i, Corsa 1.6i, Corsa 1.4i Sail Hatchback			0 450 905 280	0 451 103 079
Vectra C [Z02]			0 450 905 316	
<b>PORSCHE</b>				
718 Boxster [982], 718 Cayman [982C]				F 026 407 314
911 [991], 911 [991] Cabriolet	F 026 400 755			F 026 407 102
911 [997], Boxster [987], Cayman [987C]		1 987 432 200		
911 [997], Boxster [987], Cayman [987C]		1 987 432 407		
Boxster [987] (P) 217 Kw (2006.09 -2008.08), Cayman [987C] (P) 217 Kw (2005.11 -2009.01), 911 [997] (P) 235 Kw (2004.07 -2008.05), Cayenne [9PA] (P) 250 Kw (2002.09 -2007.01)				1 457 429 144
Boxster [987] (P) 235 Kw (2010.09 -2012.09), Boxster [981], Cayman [987C] (P) 235 Kw (2009.02 -2012.12), Cayman [987C] (P) 243 Kw (2010.02 -2012.12), Boxster [987] (P) 188 Kw (2009.02 -2012.09), Cayman [981C]				F 026 407 312
Cayenne [92A]	F 026 400 182	0 986 628 591		
Cayenne [92A]	F 026 400 182	1 987 435 512		
Cayenne [92A] (D) 281 Kw (2012.09 -2014.08), Cayenne [92A] (D) 176 Kw (2010.09 -2011.08)				F 026 407 066
Cayenne [92A] (P) 220 Kw (2010.07 -2014.08)				F 026 407 320
Cayenne [92A] (P) 294 Kw (2010.09 -2014.08), Panamera [970] (P) 309 Kw (2013.07 -2016.08), Panamera [970] (P) 368 Kw (2009.03 -2013.09), Cayenne [9PA] (P) 283 Kw (2007.02 -2010.09), Cayenne [92A] (P) 419 Kw (2014.09 -2018.05), Panamera [970] (P) 294 Kw (2009.03 -2013.09), Panamera [970] (P) 220 Kw (2010.05 -2013.09), Cayenne [9PA] (P) 368 Kw (2007.02 -2010.08), 911 [997] (P) 254 Kw (2008.06 -2012.09)				F 026 407 102
Cayenne [9PA]	F 026 400 182	1 987 432 431		
Macan [95B]		0 986 628 622		
Macan [95B]		1 987 432 369		
Macan [95B] (P) 174 Kw (2015.10 -2018.08), Macan [95B] (P) 195 Kw (2021.09-->)				F 026 407 278
Macan [95B] (P) 280 Kw (2021.09-->), Macan [95B] (P) 324 Kw (2021.09-->)				F 026 407 274
Panamera [970] (D) 185 Kw (2011.08 -2016.08), Macan [95B] (D) 190 Kw (2014.03 -2018.08)				F 026 407 122
<b>RENAULT</b>				
Duster 1.5 TD		F 002 H24 948		F 026 407 022
Duster 1.6		F 002 H24 948	0 450 902 161	

### Brand wise Filter Application Chart

Model Description	Air Filter	Cabin Filter	Fuel Filter	Oil Filter
Duster dCi, Duster [HS]		0 986 628 502		F 026 407 022
Duster dCi, Duster [HS]		1 987 435 501		F 026 407 022
Fluence [L3]		1 987 432 247	0 450 902 161	
Fluence [L3]		1 987 435 574	0 450 902 161	
Fluence [L3] (P) 103 Kw (2010.02 -2016.12)				F 026 407 209
Koleos [HY]	F 026 400 738			F 026 407 014
Kwid 0.8	F 002 H27 541			F 002 H26 501
Kwid 1.0				F 002 H26 501
Laguna III [BT], Fluence [L3] (D) 78 Kw (2009.11 -2016.12)				F 026 407 022
Logan 1.4i			0 450 902 161	F 002 H23 551
Logan [KS/FS] MCV		0 986 628 502		
Logan [KS/FS] MCV		1 987 435 501		
Pulse 1.2i	F 026 400 222			
<b>ROLLS-ROYCE</b>				
Phantom [RR1]	1 457 433 091			
Wraith [RR5], Dawn [RR6], Ghost [RR4]		0 986 628 558		F 026 407 158
Wraith [RR5], Dawn [RR6], Ghost [RR4]		1 987 435 064		F 026 407 158
<b>SKODA</b>				
Fabia 1.6 i		1 987 432 057		F 026 407 183
Fabia [5J2, 542]		1 987 432 057	0 450 906 500	F 026 407 183
Fabia [5J2, 542] (D) 51 Kw (2007.02 -2010.03)	1 457 433 575	1 987 432 357		1 457 429 192
Fabia [5J2, 542] (D) 55 Kw (2010.03 -2014.12)	F 026 400 391	1 987 432 357		F 026 407 144
Fabia [5J2, 542] (D) 55 Kw (2010.03 -2014.12)	F 026 400 391	1 987 435 502		F 026 407 144
Fabia [5J2, 542] (P) 44 Kw (2006.12 -2009.05)		1 987 432 357	F 026 403 006	1 457 429 194
Fabia [5J2, 542] (P) 63 Kw (2007.01 -2010.03)	F 026 400 035	1 987 432 357	F 026 403 006	
Fabia [5J2, 542] (P) 63 Kw (2010.03 -2014.12)	F 026 400 391	1 987 432 357	0 450 905 959	
Fabia [5J2, 542] (P) 63 Kw (2010.03 -2014.12)	F 026 400 391	1 987 435 502	0 450 905 959	
Kodiaq [NS]	F 026 400 287	0 986 628 630		
Kodiaq [NS]	F 026 400 287	1 987 432 540		
Kodiaq [NS] (D) 140 Kw (2016.10-->), Kodiaq [NS] (D) 130 Kw (2018.07-->)			1 457 070 014	
Kodiaq [NS] (D) 140 Kw (2016.10-->), Kodiaq [NS] (D) 130 Kw (2018.07-->)			F 026 402 254	
Laura	1 987 429 404	1 987 432 097	1 457 070 007	1 457 429 192
Laura	1 987 429 404	1 987 432 597	1 457 070 007	1 457 429 192
Laura 2.0 TDI, Laura 1.9 TDI		1 987 432 097		
Octavia [1U2]	1 457 433 714	1 987 432 012	0 450 905 318	0 451 103 314
Octavia [1U2]	1 457 433 714	1 987 432 012	0 450 905 318	1 457 429 619
Octavia [1U2]	1 457 433 714	1 987 432 012	0 450 906 374	0 451 103 314

### Brand wise Filter Application Chart

Model Description	Air Filter	Cabin Filter	Fuel Filter	Oil Filter
Octavia [1U2] (P) 110 Kw (1998.03 -2010.12), Octavia [1U2] (D) 66 Kw (2001.11 -2009.12), Octavia [1U5] Combi (D) 66 Kw (1998.05 -2009.12), Octavia [1U2] (P) 85 Kw (2000.08 -2005.01)		1 987 432 300		
Octavia [1U2] (P) 110 Kw (1998.03 -2010.12), Octavia [1U2] (D) 66 Kw (2001.11 -2009.12), Octavia [1U5] Combi (D) 66 Kw (1998.05 -2009.12), Octavia [1U2] (P) 85 Kw (2000.08 -2005.01)		1 987 432 312		
Octavia [1U2], Octavia [1U5] Combi	1 457 433 714	1 987 432 012	0 450 906 374	1 457 429 619
Octavia [5E3]		0 986 628 630		F 026 407 278
Octavia [5E3]		1 987 432 540		F 026 407 278
Octavia [5E3] (D) 105 Kw (2013.10 -2020.10)	F 026 400 287		1 457 070 014	
Octavia [5E3] (D) 105 Kw (2013.10 -2020.10)	F 026 400 287		F 026 402 254	
Octavia [5E3] (P) 103 Kw (2013.10 -2015.05)	F 026 400 342			
Octavia [5E3] (P) 169 Kw (2017.09 -2017.02), Octavia [5E3] (P) 132 Kw (2013.10 -2020.10)	F 026 400 287			
Rapid 1.6			F 026 403 006	F 026 407 183
Rapid 1.6D		1 987 432 057	0 450 906 500	
Superb 2.5 TDI			0 986 450 509	1 457 429 152
Superb [3T4]		1 987 432 097	0 450 905 959	
Superb [3T4]		1 987 432 097	F 026 402 217	
Superb [3T4]		1 987 432 597	0 450 905 959	
Superb [3T4]		1 987 432 597	F 026 402 217	
Superb [3T4] (D) 103 Kw (2009.01 -2010.03)	1 987 429 404			1 457 429 192
Superb [3T4] (D) 103 Kw (2010.02 -2015.05)	1 987 429 404			F 026 407 023
Superb [3T4] (P) 191 Kw (2008.11 -2015.05)	F 026 400 180			1 457 429 192
Superb [3T4] (P) 191 Kw (2008.11 -2015.05)	F 026 400 180			F 026 407 320
Superb [3U4]	1 457 433 698	0 986 628 563	0 450 905 264	0 451 103 313
Superb [3U4]	1 457 433 698	1 987 432 012	0 450 905 264	0 451 103 313
Superb [3U4]	1 457 433 698	1 987 432 312	0 450 905 264	0 451 103 313
Superb [3V3]	F 026 400 287	0 986 628 630		F 026 407 278
Superb [3V3]	F 026 400 287	1 987 432 540		F 026 407 278
Yeti [5L7]	1 987 429 404	1 987 432 097		F 026 407 023
Yeti [5L7]	1 987 429 404	1 987 432 597		F 026 407 023
<b>SUZUKI</b>				
Baleno 1.3 TD	F 002 H26 332	F 002 H24 939		F 002 H23 432
S-Cross 1.3 TD		F 002 H24 940	F 002 H24 990	F 002 H23 432
S-Cross 1.6 TD		F 002 H24 940		
<b>TATA MOTORS</b>				
1.4TD eV2, Indigo 1.4i, Indica 1.4 Turbodiesel, Indigo 1.2i eCS	F 002 H26 323			F 002 H23 434
207 DI 3.0 Diesel	F 002 H24 419		9 451 037 404	
207 DI 3.0 Diesel	F 002 H24 419		9 451 037 405	

### Brand wise Filter Application Chart

Model Description	Air Filter	Cabin Filter	Fuel Filter	Oil Filter
207 DI 3.0 Diesel	F 002 H24 419		F 002 H26 307	
207 DI 3.0 Diesel	F 002 H24 419		F 002 H26 625	
207 DI 3.0 Diesel (D) 48 Kw (2002.05 -2013.06), 207 DI EX (D) 48 Kw (2005.05 -2013.07)				F 002 H20 236
207 DI 3.0 Diesel (D) 48 Kw (2002.05 -2013.06), 207 DI EX (D) 48 Kw (2005.05 -2013.07)				F 002 H23 566
207 DI Crew Cab	F 002 H24 419			F 002 H20 236
207 DI EX	F 002 H24 419			
Aria 2.2D				3 397 005 295
Bolt 1.2 T, Indigo Marina 1.4TD (D) 46 Kw (2004.09 -2005.05), ZEST 1.2 T				F 002 H60 001
Indica 1.2 CNG			F 002 R20 002	F 002 H23 434
Indica 1.2 CNG			F 002 R20 002	F 002 H60 001
Indica 1.2 LPG, Indica 1.2i 8V (P) 48 Kw (2006.11 -2011.10), Indica 1.2 CNG (P+GAS) 41 Kw (2013.11 -2016.04)	F 002 H26 323			
Indica 1.2i 8V (P) 48 Kw (2006.11 -2011.10), Indica 1.2 CNG (P+GAS) 41 Kw (2013.11 -2016.04), Indica 1.4i (P) 55 Kw (2001.07 -2008.05)	F 002 H20 272			
Indica 1.4 Diesel			F 002 H21 299	F 002 H20 264
Indica 1.4 Diesel			F 002 H21 299	F 002 H21 221
Indica 1.4 Diesel (D) 39 Kw (1998.12 -2012.06)	F 002 H20 272			F 002 H20 264
Indica 1.4 Diesel (D) 39 Kw (1998.12 -2012.06)	F 002 H20 272			F 002 H23 432
Indica 1.4 Diesel (D) 39 Kw (1998.12 -2012.06)	F 002 H26 323			F 002 H20 264
Indica 1.4 Diesel (D) 39 Kw (1998.12 -2012.06)	F 002 H26 323			F 002 H23 432
Indica 1.4 Diesel 8V (D) 50 Kw (2008.05 -2010.01)	F 002 H20 272		F 002 H21 299	F 002 H23 434
Indica 1.4 Diesel 8V (D) 50 Kw (2008.05 -2010.01)	F 002 H20 272		F 002 H21 299	F 002 H60 001
Indica 1.4 Diesel 8V (D) 50 Kw (2008.05 -2010.01)	F 002 H20 272		F 002 H26 625	F 002 H23 434
Indica 1.4 Diesel 8V (D) 50 Kw (2008.05 -2010.01)	F 002 H20 272		F 002 H26 625	F 002 H60 001
Indica 1.4 Diesel 8V (D) 50 Kw (2008.05 -2010.01)	F 002 H26 323		F 002 H21 299	F 002 H60 001
Indica 1.4 Diesel 8V, Indigo Marina 1.4TD (D) 51 Kw (2005.06 -2010.03), Indigo Marina 1.4TD (D) 46 Kw (2004.09 -2005.05), Bolt 1.2 TD, Indigo 1.4i eCS				F 002 H23 434
Indica 1.4 Turbodiesel (D) 50 Kw (2005.10 -2010.01)			F 002 H21 299	F 002 H60 001
Indica 1.4 Turbodiesel (D) 50 Kw (2005.10 -2010.01)			F 002 H26 359	F 002 H60 001
Indica 1.4 Turbodiesel (D) 50 Kw (2005.10 -2010.01)			F 002 H26 625	F 002 H60 001
Indica 1.4 Turbodiesel (D) 50 Kw (2005.10 -2010.01), Indigo 1.2i (P) 74 Kw (2007.02 -2011.01), Indigo 1.4i (D) 51 Kw (2007.02 -2011.01)			F 002 H26 359	F 002 H23 434

### Brand wise Filter Application Chart

Model Description	Air Filter	Cabin Filter	Fuel Filter	Oil Filter
Indica 1.4 Turbodiesel (D) 50 Kw (2005.10 -2010.01), Indigo 1.2i (P) 74 Kw (2007.02 -2011.01), Indigo 1.4i (D) 51 Kw (2007.02 -2011.01)			F 002 H26 625	F 002 H23 434
Indica 1.4 Turbodiesel (D) 50 Kw (2005.10 -2010.01), Indigo 1.4D CS			F 002 H21 299	F 002 H23 434
Indica 1.4i			F 002 R20 002	F 002 H20 264
Indica 1.4i (P) 44 Kw (1998.12 -2000.04)	F 002 H20 272		F 002 H21 299	F 002 H20 264
Indica 1.4i (P) 44 Kw (1998.12 -2000.04)	F 002 H20 272		F 002 H21 299	F 002 H23 432
Indica 1.4i (P) 44 Kw (1998.12 -2000.04)	F 002 H20 272		F 002 H26 359	F 002 H20 264
Indica 1.4i (P) 44 Kw (1998.12 -2000.04)	F 002 H20 272		F 002 H26 359	F 002 H23 432
Indica 1.4i (P) 44 Kw (1998.12 -2000.04)	F 002 H26 323		F 002 H21 299	F 002 H20 264
Indica 1.4i (P) 44 Kw (1998.12 -2000.04)	F 002 H26 323		F 002 H26 359	F 002 H20 264
Indica 1.4i (P) 44 Kw (1998.12 -2000.04)	F 002 H26 323		F 002 H26 359	F 002 H23 432
Indica 1.4i (P) 44 Kw (1998.12 -2000.04), Indica Vista 1.4 Diesel 8V	F 002 H26 323		F 002 H21 299	F 002 H23 432
Indica Vista 1.2D	F 002 H24 980			F 002 H23 432
Indica Vista 1.2i 8V	F 002 H24 980		F 002 H24 518	F 002 H23 434
Indica Vista 1.4i	F 002 H24 980		F 002 H24 518	
Indigo 1.2i (P) 74 Kw (2007.02 -2011.01)			F 002 H24 518	F 002 H23 432
Indigo 1.2i (P) 74 Kw (2007.02 -2011.01)			F 002 H26 359	F 002 H20 264
Indigo 1.2i (P) 74 Kw (2007.02 -2011.01)			F 002 H26 359	F 002 H23 432
Indigo 1.2i (P) 74 Kw (2007.02 -2011.01)			F 002 H26 625	F 002 H20 264
Indigo 1.2i (P) 74 Kw (2007.02 -2011.01)			F 002 H26 625	F 002 H23 432
Indigo 1.2i (P) 74 Kw (2007.02 -2011.01), Indica 1.2i 8V, Indica 1.2 CNG			F 002 H24 518	F 002 H23 434
Indigo 1.2i (P) 74 Kw (2007.02 -2011.01), Indica 1.4i			F 002 H24 518	F 002 H20 264
Indigo 1.2i CS	F 002 H26 323		F 002 H24 518	F 002 H23 434
Indigo 1.2i CS	F 002 H26 323		F 002 H24 518	F 002 H60 001
Indigo 1.2i eCS (P) 48 Kw (2011.09 -2018.08), Indigo Manza 1.4i (P) 66 Kw (2009.10 -2011.02)			F 002 H24 518	
Indigo 1.2i eCS (P) 48 Kw (2011.09 -2018.08), Sumo 3.0 Diesel BS2 Spacio, Movus 2.2TD, Sumo 1.9 Turbodiesel, Sumo 1.9 Turbodiesel 4x4 (D) 66 Kw (2001.01 -2004.01), Sumo 3.0D Spacio (D) 48 Kw (2000.02 -2004.10), Indigo 1.4D (D) 51 Kw (2005.06 -2009.10), Winger 1.9 Diesel (D) 66 Kw (2007.05 -2016.06), Sierra 1.9 Diesel, Safari 2.0 Turbodiesel, Sumo 2.2D Grande (D) 88 Kw (2008.02-->), Safari 2.2 Diesel P5, Safari 3.0D 4x4 Dicor (D) 85 Kw (2005.08 -2007.09), Estate 1.9 Diesel, Safari 2.0 Turbodiesel 4x4, Sierra 1.9 Turbodiesel			F 002 H26 625	
Indigo 1.2i, Indigo 1.2i eCS, Indigo 1.2i eCS CNG	F 002 H26 323			F 002 H60 001
Indigo 1.4 Turbodiesel	F 002 H26 323		F 002 H26 359	F 002 H60 001
Indigo 1.4D CS (D) 51 Kw (2008.05 -2009.10)	F 002 H26 323		F 002 H26 625	



## Brand wise Filter Application Chart

Model Description	Air Filter	Cabin Filter	Fuel Filter	Oil Filter
Indigo 1.4D eCS, Indica 1.4 Diesel 8V (D) 50 Kw (2008.05 -2010.01), Indigo 1.4D	F 002 H26 323		F 002 H21 299	F 002 H23 434
Indigo 1.4i (P) 63 Kw (2006.09 -2009.10), Indica 1.2i 8V, Indica 1.2 CNG			F 002 H24 518	F 002 H60 001
Indigo 1.4i eCS (D) 51 Kw (2011.09 -2017.06), Indica 1.4i (P) 55 Kw (2000.05 -2010.01)	F 002 H20 272		F 002 H24 518	
Indigo 1.4i eCS (D) 51 Kw (2011.09 -2017.06), Indica 1.4i (P) 55 Kw (2000.05 -2010.01)	F 002 H26 323		F 002 H24 518	
Indigo 1.4i eCS (D) 51 Kw (2011.09 -2017.06), Indigo 1.4D CS (D) 51 Kw (2008.03 -2011.09)	F 002 H20 272		F 002 H21 299	
Indigo 1.4i eCS (D) 51 Kw (2011.09 -2017.06), Indigo 1.4D CS (D) 51 Kw (2008.03 -2011.09)	F 002 H26 323		F 002 H21 299	
Indigo Manza 1.4i (P) 66 Kw (2009.10 -2011.02)			F 026 402 076	
Indigo Marina 1.4 Diesel 16V, Indica 1.4 Diesel 8V (D) 50 Kw (2008.05 -2010.01)	F 002 H26 323		F 002 H26 625	F 002 H23 434
Indigo Marina 1.4TD	F 002 H26 323		F 002 H26 359	
Indigo Marina 1.4i, Indica 1.4 Diesel 8V (D) 50 Kw (2008.05 -2010.01)	F 002 H26 323		F 002 H26 625	F 002 H60 001
Nano 0.6i, Nano 0.6i CNG, Nano Twist 0.6, Nano 0.6				F 002 H24 495
Safari 2.0 Turbodiesel 4x4 (D) 66 Kw (1998.02 -2007.09), Safari 2.0 Turbodiesel (D) 66 Kw (1998.02 -2008.12)			F 002 H20 113	
Safari 2.2			F 002 H21 299	F 002 H23 566
Sierra 1.9 Turbodiesel 4WD				F 002 H26 361
Sumo 1.9 Diesel			F 002 H26 307	9 951 030 134
Sumo 1.9 Diesel			F 002 H26 625	9 951 030 134
Sumo 1.9 Turbodiesel 4x4, Sumo 3.0 Diesel BS2 Spacio, Safari 2.0 Turbodiesel 4x4 (D) 66 Kw (1998.02 -2007.09), Safari 2.0 Turbodiesel (D) 66 Kw (1998.02 -2008.12), Estate 1.9 Diesel, Sumo 1.9 Turbodiesel, Sierra 1.9 Turbodiesel, Sierra 1.9 Diesel			F 002 H26 307	
Sumo 2.2D Grande (D) 88 Kw (2008.02-->), Indigo 1.4D (D) 51 Kw (2007.02 -2009.10), Sumo 1.9 Turbodiesel 4x4 (D) 66 Kw (2001.01 -2004.01), Safari 4x2 Dicor (D) 85 Kw (2005.08 -2008.12), Sumo 1.9D Grande, Safari 4x2 Dicor, Winger 1.9 Diesel (D) 66 Kw (2007.05 -2016.06)			F 002 H21 299	
Sumo 2.2D Grande (D) 88 Kw (2008.02-->), Safari 3.0D 4x4 Dicor (D) 85 Kw (2005.08 -2007.09), Safari 4x2 Dicor (D) 85 Kw (2005.08 -2008.12)			F 002 H26 359	
Sumo 3.0 Diesel	F 002 H24 419		F 002 H26 307	F 002 H20 236
Sumo 3.0 Diesel	F 002 H24 419		F 002 H26 625	F 002 H20 236
Sumo 3.0 Diesel BS2 Spacio (D) 48 Kw (2000.02-->)				9 451 037 456
Sumo 3.0 Diesel BS2 Spacio (D) 48 Kw (2000.02-->)				F 002 H60 003
Sumo 3.0D Spacio			9 451 037 404	9 451 037 456
Sumo 3.0D Spacio			9 451 037 404	F 002 H60 003
Sumo 3.0D Spacio			9 451 037 405	9 451 037 456

## Brand wise Filter Application Chart

Model Description	Air Filter	Cabin Filter	Fuel Filter	Oil Filter
Sumo 3.0D Spacio			9 451 037 405	F 002 H60 003
Sumo 3.0D Spacio			F 002 H26 307	9 451 037 456
Sumo 3.0D Spacio			F 002 H26 307	F 002 H60 003
Sumo 3.0D Spacio (D) 48 Kw (2000.02 -2004.10)			9 451 037 405	
Sumo Gold 3.0 d	F 002 H24 419		F 002 H26 307	9 451 037 456
Sumo Gold 3.0 d, Sumo 3.0 Diesel 8V	F 002 H24 419		F 002 H26 625	9 451 037 456
Tiago 1.0 BS IV Multi Drive, TIGOR 1.0	F 002 H26 395			
Winger 1.9 Diesel			F 002 H24 509	F 002 H23 566
Winger Van 1.9 D			F 002 H24 509	
ZEST 1.2 TD, Indigo Manza 1.4i	F 002 H24 980			F 002 H23 434
ZEST 1.24 TD XTA, Indica Vista 1.3 TD, Indigo Manza 1.2 TD			F 026 402 076	F 002 H23 434
<b>TOYOTA</b>				
Camry 2.4 i Sedan (P) 123 Kw (2006.01 -2011.09)				0 986 AF1 043
Camry 2.4, Camry 2.4 i Sedan (P) 123 Kw (2006.01 -2011.09)				0 986 452 044
Corolla 1.8i, Corolla Altis 1.8i, Corolla Altis 1.8 i, New Corolla Altis 1.8i, Corolla Altis 1.8	F 026 400 017			
Corolla [E15]		1 987 432 190	F 026 402 110	0 986 452 044
Etios 1.4D Liva, Etios 1.4D, Etios Cross 1.4TD	F 002 H24 971	F 002 H24 983		F 002 H24 988
Etios 1.5i, Etios 1.5 Liva, Etios Cross 1.5 V, Etios 1.2i Liva		F 002 H24 983		
Etios Cross 1.2 G	F 002 H24 971	F 002 H24 983		
Fortuner 2.5 D-4D	F 026 400 344	F 002 H24 941	F 002 H23 416	0 986 452 044
Fortuner 3.0 Diesel Turbo	F 026 400 344	1 987 432 190		0 986 452 044
Fortuner [N5,N6]	F 026 400 344			0 986 452 044
Fortuner [N5,N6] (D) 120 Kw (2005.01 -2012.04)		1 987 432 084		
Innova 2.0 CNG		F 002 H24 941		0 986 452 044
Innova 2.0 CNG (P+GAS) 100 Kw (2009.02 -2013.05), Innova 2.5 CRDi (D) 75 Kw (2004.12 -2019.01)	F 002 H23 418			
Innova 2.0 CNG (P+GAS) 100 Kw (2009.02 -2013.05), Innova 2.5 CRDi (D) 75 Kw (2004.12 -2019.01)	F 026 400 344			
Innova 2.0i, Innova 2.0	F 026 400 344	F 002 H24 941		0 986 452 044
Innova 2.5 CRDi		F 002 H24 941	F 002 H23 416	F 002 H23 413
Land Cruiser Prado [J12]		1 987 432 085	F 026 403 756	0 986 452 044
Prius [W30], Fortuner [N5,N6] (D) 120 Kw (2005.01 -2012.04)		1 987 432 190		
<b>VOLKSWAGEN</b>				
Beetle [5C1]	F 026 400 342	1 987 432 097	0 450 905 959	
Beetle [5C1]	F 026 400 342	1 987 432 597	0 450 905 959	
Jetta 1.9TDI	1 457 433 714			
Jetta [162]	1 987 429 404	1 987 432 097	0 450 905 959	F 026 407 023
Jetta [162]	1 987 429 404	1 987 432 097	0 450 905 959	F 026 407 183







### Brand wise Filter Application Chart

Model Description	Air Filter	Cabin Filter	Fuel Filter	Oil Filter
Jetta [162]	1 987 429 404	1 987 432 597	0 450 905 959	F 026 407 023
Jetta [162]	1 987 429 404	1 987 432 597	0 450 905 959	F 026 407 183
Jetta [9M2]				0 986 MFO 081
New Beetle [1C1, 9C1]	1 457 433 714	1 987 432 300		
New Beetle [1C1, 9C1] (P) 85 Kw (2001.06 -2010.09)			0 450 905 318	0 451 103 314
New Beetle [1C1, 9C1] (P) 85 Kw (2001.06 -2010.09)			0 450 905 318	0 986 MFO 081
New Beetle [1C1, 9C1] (P) 85 Kw (2001.06 -2010.09)			0 450 905 925	0 451 103 314
New Beetle [1C1, 9C1] (P) 85 Kw (2001.06 -2010.09)			0 450 905 925	0 986 MFO 081
New Beetle [1C1, 9C1] (P) 85 Kw (2001.06 -2010.09)			F 026 403 006	0 451 103 314
New Beetle [1C1, 9C1] (P) 85 Kw (2001.06 -2010.09)			F 026 403 006	0 986 MFO 081
Passat 1.8i		1 987 432 012		
Passat [362]	1 987 429 404	1 987 432 097	F 026 402 809	F 026 407 023
Passat [362]	1 987 429 404	1 987 432 597	F 026 402 809	F 026 407 023
Passat [3C2]	1 987 429 404	1 987 432 097		1 457 429 192
Passat [3C2]	1 987 429 404	1 987 432 597		1 457 429 192
Polo 1.2D, CrossPolo 1.5 TDi			0 450 906 500	
Polo 1.5 TD		1 987 432 012	0 450 906 500	
Polo 1.5 TD, Polo 1.5 TDi, Vento 1.5 TD, Vento 1.6 D, Vento 1.5 TDi		1 987 432 312	0 450 906 500	
Polo 1.6, Vento 1.6 MPI				F 026 407 183
Polo MPI, Ameo BS6 Corporate Edition				1 457 429 194
Polo [6R1]	F 026 400 391	1 987 432 057	0 450 905 959	
Polo [6R1]	F 026 400 391	1 987 432 057	0 450 906 500	
Polo [6R1] (D) 55 Kw (2013.09 -2014.09)		1 987 432 357		F 026 407 144
Polo [6R1] (D) 55 Kw (2013.09 -2014.09)		1 987 435 502		F 026 407 144
Polo [6R1] (D) 77 Kw (2013.09 -2014.06)		1 987 432 357		F 026 407 023
Polo [6R1] (D) 77 Kw (2013.09 -2014.06)		1 987 435 502		F 026 407 023
Polo [6R1] (P) 77 Kw (2013.04 -2014.05)		1 987 432 357		F 026 407 181
Polo [6R1] (P) 77 Kw (2013.04 -2014.05)		1 987 432 357		F 026 407 183
Polo [6R1] (P) 77 Kw (2013.04 -2014.05)		1 987 435 502		F 026 407 181
Polo [6R1] (P) 77 Kw (2013.04 -2014.05)		1 987 435 502		F 026 407 183
TIGUAN BS-VI 4WD	F 026 400 287			F 026 407 278
Tiguan [AD1]	F 026 400 287	0 986 628 630		
Tiguan [AD1]	F 026 400 287	1 987 432 540		
Tiguan [AD1] (D) 140 Kw (2017.05 -2020.07)			1 457 070 014	
Tiguan [AD1] (D) 140 Kw (2017.05 -2020.07)			F 026 402 254	
Touareg [7LA]	F 026 400 182	1 987 432 431	1 457 070 010	F 026 407 002
Touareg [7P5]	F 026 400 182	0 986 628 591		F 026 407 122
Touareg [7P5]	F 026 400 182	1 987 435 512		F 026 407 122
VENTO BS-VI	F 026 400 391			F 026 407 183

### Brand wise Filter Application Chart

Model Description	Air Filter	Cabin Filter	Fuel Filter	Oil Filter
Vento 1.2, POLO, Ameo 1.0, Cross Polo 1.2, Passat 1.8i, Vento 1.6 i, Polo 1.5 TDI, Ameo 1.2, Ameo 1.5TDi		1 987 432 312		
Vento 1.5 TDI HIGHLINE, POLO BS-VI, Ameo BS-VI	F 026 400 391		0 450 906 500	F 026 407 023
<b>VOLVO</b>				
S60 I [384], XC90 I [275]	F 026 400 026	1 987 432 531		
S60 I [384], XC90 I [275]	F 026 400 026	1 987 435 061		
S80 I [184]		1 987 432 531		
S80 I [184]		1 987 435 061		
S80 II [124]		0 986 628 561		
S80 II [124]		1 987 432 405		
S80 II [124] (D) 136 Kw (2006.03 -2009.07), S80 II [124] (D) 120 Kw (2012.08 -2016.08)	F 026 400 513			
S80 II [124] (P) 232 Kw (2006.03 -2010.12)	F 026 400 181			
V40 [526] Cross Country		1 987 435 018		F 026 407 078
V90 II [235], XC60 II [246], XC90 II [256], S90 II [234]		0 986 628 575		
XC60 I [156], V60 [155], S60 II [134], S60 [134] Cross Country	F 026 400 513	0 986 628 561		
XC60 I [156], V60 [155], S60 II [134], S60 [134] Cross Country	F 026 400 513	1 987 432 405		

### Filter Application Chart









Part Number	Product Description	Image	Model Description 	Potential OE Part No	Potential Comp. Part No	MRP (₹)
F 002 H24 419	Air Filter Element Primary, Engine		TATA MOTORS- 207 DI EX, 207 DI 3.0 Diesel	254709130241, 253409130258, 253409130241, 253409130262, 253409130368		835.00
0 986 AF2 359	Air Filter Element, Engine		ISUZU- D-Max	8979445700		On Request
1 457 433 043	Air Filter Element, Engine		MERCEDES-BENZ- C-Klasse [203] (P) 95 Kw (2000.10 -2002.08)	1110940304		1,345.00
1 457 433 046	Air Filter Element, Engine		AUDI- A4 [8EC, B7], A4 [8E2, B6]			On Request
1 457 433 065	Air Filter Element, Engine		MERCEDES-BENZ- C-Klasse [203] (D) 100 Kw (2004.01 -2007.12), C-Klasse [203] (D) 75 Kw (2000.07 -2003.06), E-Klasse [210]	6110940104		1,045.00

### Filter Application Chart





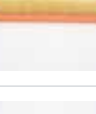

Part Number	Product Description	Image	Model Description 	Potential OE Part No	Potential Comp. Part No	MRP (₹)
1 457 433 071	Air Filter Element, Engine		MERCEDES-BENZ- S-Klasse [221] (P) 170 Kw (2005.09 -2009.12), SLK-Klasse [171] (P) 200 Kw (2004.04 -2008.12), G-Klasse [463] (P) 350 Kw (2004.04 -2011.08), E-Klasse [211] (P) 130 Kw (2002.03 -2006.06), E-Klasse [207] Cabrio, CLS-Klasse [219] (P) 285 Kw (2006.04 -2011.08), M-Klasse [164] (P) 200 Kw (2005.09 -2011.06), CLK-Klasse [209] Cabrio, CL-Klasse [216], CLS-Klasse [219] (P) 200 Kw (2004.06 -2009.12), R-Klasse [251] (P) 200 Kw (2005.09 -2012.10), SLK-Klasse [171] (P) 265 Kw (2004.04 -2010.11), S-Klasse [220], C-Klasse [203] (P) 270 Kw (2004.02 -2007.08), E-Klasse [211] (P) 170 Kw (2006.01 -2009.03), S-Klasse [221] (P) 200 Kw (2009.01 -2012.12), E-Klasse [211] (P) 150 Kw (2007.09 -2009.03), SL-Klasse [230], E-Klasse [207] Coupe	2730940404		On Request
1 457 433 091	Air Filter Element, Engine		ROLLS-ROYCE- Phantom [RR1]			On Request
1 457 433 091	Air Filter Element, Engine		BMW- 7 [E 65] (P) 327 Kw (2002.12 -2008.10)	13717505007, 13717526008		On Request
1 457 433 094	Air Filter Element, Engine		BMW- 5 [E 60] (P) 130 Kw (2005.03 -2010.02), 5 [E 60] (P) 187 Kw (2005.03 -2010.02), 5 [E 60] (P) 160 Kw (2007.03 -2008.07)	13717521033		On Request
1 457 433 101	Air Filter Element, Engine		BMW- 6 [E 63], 6 [E 64] Cabrio	13717521023		On Request



### Filter Application Chart

Part Number	Product Description	Image	Model Description 	Potential OE Part No	Potential Comp. Part No	MRP (₹)
1 457 433 286	Air Filter Element, Engine		FIAT- Uno '98 [146]	71754227		963.00
1 457 433 575	Air Filter Element, Engine		SKODA- Fabia [5J2, 542] (D) 51 Kw (2007.02 -2010.03)			995.00
1 457 433 588	Air Filter Element, Engine		LAND ROVER GROUP- Freelander [LN, L314] (D) 140 Kw (2013.03 -2015.09)			On Request
1 457 433 589	Air Filter Element, Engine		BMW- 5 [E 60] (D) 170 Kw (2005.09 -2007.02), X 5 [E 70] (D) 173 Kw (2008.10 -2010.03), 7 [E 65] (D) 170 Kw (2005.04 -2008.10)	13712247444		2,495.00
1 457 433 593	Air Filter Element, Engine		FORD- Fusion 1.6i 16V			On Request
1 457 433 698	Air Filter Element, Engine		SKODA- Superb [3U4]			708.00
1 457 433 714	Air Filter Element, Engine		SKODA- Octavia [1U2], Octavia [1U5] Combi; AUDI- TT [8N3] Coupe			550.00
1 457 433 714	Air Filter Element, Engine		VOLKSWAGEN- New Beetle [1C1, 9C1], Jetta 1.9TDI	1J0129620, 1K0129620D		550.00
1 457 433 781	Air Filter Element, Engine		LAND ROVER GROUP- Freelander [LN, L314] (D) 140 Kw (2013.03 -2015.09)			On Request

### Filter Application Chart

Part Number	Product Description	Image	Model Description 	Potential OE Part No	Potential Comp. Part No	MRP (₹)
1 457 433 953	Air Filter Element, Engine		MARUTI- Baleno 1.6i, Baleno Altura 1.6i	1378060G00		677.00
1 987 429 125	Air Filter Element, Engine		MARUTI- Gypsy 1.3 4WD, Gypsy 1.3i 4WD	1378083000		1,334.00
1 987 429 166	Air Filter Element, Engine		DAEWOO- Matiz 0.8i	96314494		670.00
1 987 429 166	Air Filter Element, Engine		CHEVROLET- Spark 1.0 LPG/CNG, Spark 1.0 i	96314494, J990435L0		670.00
1 987 429 401	Air Filter Element, Engine		MERCEDES-BENZ- C-Klasse [203] (P) 120 Kw (2002.05 -2007.02), SLK-Klasse [171] (P) 135 Kw (2007.12 -2010.11), SLK-Klasse [171] (P+GAS) 120 Kw (2004.04 -2007.11)	2710940204		On Request
1 987 429 404	Air Filter Element, Engine		AUDI- TT [8J3] Coupe (P) 155 Kw (2010.05 -2014.06), Q3 [8U]; SKODA- Superb [3T4] (D) 103 Kw (2010.02 -2015.05), Laura, Yeti [5L7], Superb [3T4] (D) 103 Kw (2009.01 -2010.03)			852.00
1 987 429 404	Air Filter Element, Engine		VOLKSWAGEN- Passat [362], Passat [3C2], Jetta [162]	1K0129620G, 1K0129620D		852.00
9 951 030 130	Air Filter Element, Engine		MARUTI- Zen 1.0i 16V, Zen 1.0i, 800 0.8i 6V	13780M78122, 1378054E00, 13780M78131		319.00
9 951 030 131	Air Filter Element, Engine		MARUTI- Omni 0.8 Generation I, Omni 0.8 LPG Generation II, Gypsy 1.0 4WD, Omni 0.8 Generation II	13780M797D0, 13780M797D1, 13780M79201, 13780M79250		400.00











### Filter Application Chart

Part Number	Product Description	Image	Model Description 	Potential OE Part No	Potential Comp. Part No	MRP (₹)
F 002 H20 272	Air Filter Element, Engine		TATA MOTORS- Indica 1.4i (P) 44 Kw (1998.12 -2000.04), Indigo 1.4i eCS (D) 51 Kw (2011.09 -2017.06), Indica 1.4i (P) 55 Kw (2000.05 -2010.01), Indica 1.2i 8V (P) 48 Kw (2006.11 -2011.10), Indica 1.2 CNG (P+GAS) 41 Kw (2013.11 -2016.04), Indica 1.4i (P) 55 Kw (2001.07 -2008.05), Indigo 1.4D CS (D) 51 Kw (2008.03 -2011.09), Indica 1.4 Diesel 8V (D) 50 Kw (2008.05 -2010.01), Indica 1.4 Diesel (D) 39 Kw (1998.12 -2012.06)	279009130147, 279009130159, 279109130112, 279709130103, 279009130158, 279109130120, G279009130131		440.00
F 002 H20 378	Air Filter Element, Engine		MARUTI- Alto 0.8i 12V, Alto 0.8i, Alto 1.1i 16V, Wagon R 1.1i 16V	13780M79F00		330.00
F 002 H23 418	Air Filter Element, Engine		TOYOTA- Innova 2.0 CNG (P+GAS) 100 Kw (2009.02 -2013.05), Innova 2.5 CRDi (D) 75 Kw (2004.12 -2019.01)	J1322083	ELF -EK5059	810.00
F 002 H23 426	Air Filter Element, Engine		MARUTI- Ritz 1.2 Generation I (D) 55 Kw (2009.05 -2012.07), Dzire 1.2, Swift 1.3 Dzire TD, Celerio 1.0 VXi Green CNG, Swift 1.3 TD (D) 56 Kw (2007.01 -2011.07), Swift 1.3 TD (D) 55 Kw (2011.08-->), Ertiga 1.3 TD Generation I, Ciaz 1.3 TD	13780M86J00		336.00
F 002 H23 427	Air Filter Element, Engine		MARUTI- Ritz 1.2 Generation I (P) 63 Kw (2009.05 -2012.07), Ertiga 1.4 CNG Generation I, Swift 1.2, Swift 1.2i, Swift 1.2i Dzire, Swift 1.3i, Swift 1.3i Dzire, Swift 1.3 TD (D) 56 Kw (2007.01 -2011.07), A-Star 1.0i 12V, Ciaz 1.4 Generation I, Ertiga 1.4 Generation I	13780M83K00, 13780M75J00, 13780M74L00		314.00
F 002 H23 584	Air Filter Element, Engine		MAHINDRA- Thar 2.5D 4x4 (D) 47 Kw (2010.12 -2013.04), Scorpio 2.2 TD, Thar 2.5 TD	0313AC0280N, 0313AAM01480N		793.00







### Filter Application Chart

Part Number	Product Description	Image	Model Description 	Potential OE Part No	Potential Comp. Part No	MRP (₹)
F 002 H23 584	Air Filter Element, Engine		MAHINDRA- Scorpio 2.6 Diesel Turbo (D) 85 Kw (2007.06 -2009.06)	0313AC0280N, 0313AAM01480N		793.00
F 002 H23 585	Air Filter Element, Engine		MAHINDRA- XYLO 2.2 TD mHawk, XYLO 2.5 TD MDI, XYLO, XYLO 2.5 TD mEagle	0313AAC04390N		977.00
F 002 H23 586	Air Filter Element, Engine		MAHINDRA- XUV500 2.2D, XUV500 2.2 W9, XUV500 2.2D 4x4	0313AAM02871N, 0313AAM00521N		972.00
F 002 H23 595	Air Filter Element, Engine		HYUNDAI- i10 1.1 i			300.00
F 002 H23 596	Air Filter Element, Engine		HYUNDAI- i20 1.2i 16V, i20 1.4 TD, i20 1.2i, i20 [PB, PBT]	281131J000, 28113C7000		480.00
F 002 H24 400	Air Filter Element, Engine		CHEVROLET- Tavera 2.0D, Tavera 2.5D	T97691462		575.00
F 002 H24 419	Air Filter Element, Engine		TATA MOTORS- Sumo Gold 3.0 d, 207 DI EX, 207 DI Crew Cab, Sumo 3.0 Diesel, Sumo 3.0 Diesel 8V, 207 DI 3.0 Diesel	254709130241, 253409130258, 253409130241, 253409130262, 253409130368		835.00
F 002 H24 967	Air Filter Element, Engine		HYUNDAI- Verna 1.4D, Verna 1.6D	281131V100		363.00
F 002 H24 971	Air Filter Element, Engine		TOYOTA- Etios Cross 1.2 G, Etios 1.4D Liva, Etios 1.4D, Etios Cross 1.4TD	178010N050		315.00

### Filter Application Chart









Part Number	Product Description	Image	Model Description 	Potential OE Part No	Potential Comp. Part No	MRP (₹)
F 002 H24 974	Air Filter Element, Engine		CHEVROLET- Beat 0.9D	J96827715		410.00
F 002 H24 975	Air Filter Element, Engine		HYUNDAI- Grand i10 1.1 TD, Xcent 1.1 TD			302.00
F 002 H24 976	Air Filter Element, Engine		HONDA- Amaze First Gen 1.5	17220RNYE01		450.00
F 002 H24 977	Air Filter Element, Engine		HYUNDAI- Eon 0.8 i	281134N000		244.00
F 002 H24 978	Air Filter Element, Engine		MARUTI- Alto 800 CNG, Alto 800	13870M53M00, 13870M53M30		230.00
F 002 H24 979	Air Filter Element, Engine		MARUTI- Celerio 1.0, Alto 1.0i, Alto 1.0 CNG/LPG	13780M65L00, 13780M76M00		265.00
F 002 H24 980	Air Filter Element, Engine		TATA MOTORS- Indica Vista 1.4i, Indica Vista 1.2i 8V, Indica Vista 1.2D, ZEST 1.2 TD, Indigo Manza 1.4i	570309130108, 571209130103, 570309130107		427.00
F 002 H24 981	Air Filter Element, Engine		HYUNDAI- Grand i10 1.2, Xcent 1.2			320.00
F 002 H24 982	Air Filter Element, Engine		MARUTI- Vitara Brezza 1.2	13780M82P50		425.00

### Filter Application Chart

Part Number	Product Description	Image	Model Description 	Potential OE Part No	Potential Comp. Part No	MRP (₹)
F 002 H26 323	Air Filter Element, Engine		TATA MOTORS- Indigo 1.4D eCS, Indigo 1.4i eCS (D) 51 Kw (2011.09 -2017.06), Indica 1.2 LPG, Indigo 1.2i, Indigo Marina 1.4i, Indica 1.2i 8V (P) 48 Kw (2006.11 -2011.10), Indigo 1.4 Turbodiesel, Indica 1.2 CNG (P+GAS) 41 Kw (2013.11 -2016.04), Indica 1.4 Diesel 8V (D) 50 Kw (2008.05 -2010.01), Indigo 1.2i eCS CNG, Indica 1.4 Diesel (D) 39 Kw (1998.12 -2012.06), Indigo 1.2i CS, Indigo 1.4D CS (D) 51 Kw (2008.05 -2009.10), Indigo Marina 1.4TD, 1.4TD eV2, Indica 1.4i (P) 44 Kw (1998.12 -2000.04), Indigo Marina 1.4 Diesel 16V, Indica 1.4i (P) 55 Kw (2000.05 -2010.01), Indigo 1.4i, Indica Vista 1.4 Diesel 8V, Indica 1.4 Turbodiesel, Indigo 1.4D CS (D) 51 Kw (2008.03 -2011.09), Indigo 1.2i eCS, Indigo 1.4D	279009130133, 279009130123, 279709130127, 279109130120, 279009130132, 279109130121, 279009130122, 279709130126, 279009130131, 279109130112, G279109130120, 279709130103, G279009130132, G279009130131		300.00
F 002 H26 329	Air Filter Element, Engine		MARUTI- Versa 1.3i 16V, Eeco 1.2i	13780M83B00		300.00
F 002 H26 332	Air Filter Element, Engine		SUZUKI- Baleno 1.3 TD; MARUTI- Baleno 1.2			315.00
F 002 H26 334	Air Filter Element, Engine		HYUNDAI- i10 1.2 i 16V	281130X200		305.00
F 002 H26 339	Air Filter Element, Engine		HYUNDAI- Creta 1.4 TD, Creta 1.6 CRDi	28113A0200		337.00
F 002 H26 395	Air Filter Element, Engine		TATA MOTORS- Tiago 1.0 BS IV Multi Drive, TIGOR 1.0	570709130114, 570709130105		412.00













### Filter Application Chart

Part Number	Product Description	Image	Model Description 	Potential OE Part No	Potential Comp. Part No	MRP (₹)
F 002 H26 396	Air Filter Element, Engine		HYUNDAI- Creta 1.6	28113A0100		370.00
F 002 H26 540	Air Filter Element, Engine		MARUTI- Dzire BS IV, Tour S 1.2	13780M55R50	MHL -LX4847	330.00
F 002 H27 540	Air Filter Element, Engine		MARUTI- Wagon R 1.0, Wagon R 1.0i LPG, Zen 1.0i Estilo CNG, Zen 1.0i Estilo			250.00
F 002 H27 541	Air Filter Element, Engine		RENAULT- Kwid 0.8			220.00
F 002 H60 012	Air Filter Element, Engine		FORCE MOTORS- Toofan Classic 2.6 Diesel, Cruiser Classic 2.6 Diesel, Trax 2.4D Tempo			360.00
F 002 H60 012	Air Filter Element, Engine		MAHINDRA- Marshal 2.5 Diesel, Scorpio 2.6 Diesel Turbo 4WD, Bolero 2.5 BS III, Thar 2.5D 4x4 (D) 77 Kw (2010.12 -2013.04), Bolero Invader 2.5 Diesel 4WD, Major 2.5 Diesel, Bolero XL 2.5 Diesel, Bolero Invader 2.5 Diesel, Marshal 2.5 Diesel 4WD, Bolero 2.5 Diesel 4WD, Bolero 2.5 Diesel, Bolero 1.5 TD Power+, Maxx 2.5 Diesel Pik-Up (2005), Bolero XLS 2.5 Diesel, Scorpio 2.5D, Scorpio 2.6 Diesel Turbo (D) 80 Kw (2002.06 -2006.03), Bolero Invader GLX 2.5 Diesel, Bolero Invader GLX 2.5 Diesel 4WD, Maxx 2.5 Diesel, Bolero 2.5 BS II, Scorpio 2.6 CRDe	0313AAM02031N, 0313AC0280N, 71817, 0313AC2261N, 70632		360.00
F 026 400 017	Air Filter Element, Engine		TOYOTA- Corolla 1.8i, Corolla Altis 1.8i, Corolla Altis 1.8 i, New Corolla Altis 1.8i, Corolla Altis 1.8	178010M020		1,075.00



### Filter Application Chart

Part Number	Product Description	Image	Model Description 	Potential OE Part No	Potential Comp. Part No	MRP (₹)
F 026 400 026	Air Filter Element, Engine		VOLVO- S60 I [384], XC90 I [275]			On Request
F 026 400 035	Air Filter Element, Engine		SKODA- Fabia [5J2, 542] (P) 63 Kw (2007.01 -2010.03)			On Request
F 026 400 036	Air Filter Element, Engine		FIAT- Punto Evo [199] (P) 66 Kw (2009.10 -2011.12), Punto Evo [199] (P) 50 Kw (2010.09 -2011.12)	6000633297		On Request
F 026 400 050	Air Filter Element, Engine		BMW Mini- Mini [R 56] (P) 85 Kw (2010.03 -2013.11), Mini [R 57] Cabrio (P) 85 Kw (2010.03 -2015.06), Mini [R 60] Countryman (P) 85 Kw (2010.09 -2016.10)			On Request
F 026 400 051	Air Filter Element, Engine		NISSAN- Micra [K13K] (D) 47 Kw (2010.11-->)	1654600Q1F		On Request
F 026 400 089	Air Filter Element, Engine		JAGUAR- F-Pace [X761] Diesel and electric engine 120 Kw (2020.10-->), F-Pace [X761] (P) 280 Kw (2015.09 -2020.08), F-Pace [X761] (P) 405 Kw (2020.09-->), XE [X760], F-Pace [X761] (D) 132 Kw (2015.09 -2020.08), XF Sportbrake [X260]	T4A6124	LRG -LR092258	On Request
F 026 400 119	Air Filter Element, Engine		BMW- 3 [E 90], X 1 [E 84], 3 [E 93] Cabrio	13717797465		2,287.00
F 026 400 126	Air Filter Element, Engine		NISSAN- X-Trail [T31]	16546JD20B		On Request









### Filter Application Chart

Part Number	Product Description	Image	Model Description 	Potential OE Part No	Potential Comp. Part No	MRP (₹)
F 026 400 130	Air Filter Element, Engine		NISSAN- 370 Z [Z34] Coupe	16546JK20A		On Request
F 026 400 147	Air Filter Element, Engine		BMW- X 3 [E 83] (D) 120 Kw (2008.09 -2010.08)	13713428558		On Request
F 026 400 149	Air Filter Element, Engine		BMW- 5 [F 10] (P) 135 Kw (2012.01 -2013.09)	13717582908		On Request
F 026 400 155	Air Filter Element, Engine		MERCEDES-BENZ- G-Klasse [463] (P) 350 Kw (2004.04 -2011.08)	1130940004		On Request
F 026 400 180	Air Filter Element, Engine		SKODA- Superb [3T4] (P) 191 Kw (2008.11 -2015.05); AUDI- TT [8J3] Coupe (P) 184 Kw (2006.07 -2010.06)			1,180.00
F 026 400 181	Air Filter Element, Engine		VOLVO- S80 II [124] (P) 232 Kw (2006.03 -2010.12)			On Request
F 026 400 182	Air Filter Element, Engine		AUDI- Q7 [4LB]			1,050.00
F 026 400 182	Air Filter Element, Engine		VOLKSWAGEN- Touareg [7LA], Touareg [7P5]	7L0129620A, 7P0129620A		1,050.00
F 026 400 182	Air Filter Element, Engine		PORSCHE- Cayenne [9PA], Cayenne [92A]	95811013010, 95511013110		1,050.00







### Filter Application Chart

Part Number	Product Description	Image	Model Description 	Potential OE Part No	Potential Comp. Part No	MRP (₹)
F 026 400 219	Air Filter Element, Engine		BMW Mini- Mini [R 60] Countryman (P) 135 Kw (2010.09 -2014.06), Mini [R 56] (P) 135 Kw (2010.03 -2013.11)			On Request
F 026 400 222	Air Filter Element, Engine		NISSAN- Micra [K13K] (P) 59 Kw (2010.05 -2015.10), Micra 1.2 i; RENAULT- Pulse 1.2i	165461HC2A		1,138.00
F 026 400 223	Air Filter Element, Engine		HONDA- Jazz 1.2, City 1.5 i 8V, City 1.5, Jazz [2TF], City 1.5i 16V	17220RB0000, 17220REAZ00, 17220RNYE01, 17220RB6Z00		836.00
F 026 400 226	Air Filter Element, Engine		LEXUS- LX [J2]			On Request
F 026 400 270	Air Filter Element, Engine		BMW- 330 Li 2.0 T, 3 [F 30] (P) 135 Kw (2015.07 -2018.10)	13718605164		On Request
F 026 400 273	Air Filter Element, Engine		HYUNDAI- Santro 1.1 i 12V, Santro 1.0i 12V	2811302750		On Request
F 026 400 287	Air Filter Element, Engine		AUDI- A3 [8VS, 8VM] Limousine, Q2 [GAB, GAG], TT [FV3, FVP] Coupe, A3 [8V1, 8VK], A3 [8V7, 8VE] Cabriolet; SKODA- Octavia [5E3] (P) 169 Kw (2017.09 -2017.02), Octavia [5E3] (P) 132 Kw (2013.10 -2020.10), Octavia [5E3] (D) 105 Kw (2013.10 -2020.10), Kodiahq [NS], Superb [3V3]			On Request
F 026 400 287	Air Filter Element, Engine		VOLKSWAGEN- TIGUAN BS-VI 4WD, Tiguan [AD1]	5Q0129620B, 5Q0129620C		On Request

### Filter Application Chart











Part Number	Product Description	Image	Model Description 	Potential OE Part No	Potential Comp. Part No	MRP (₹)
F 026 400 289	Air Filter Element, Engine		AUDI- A6 [4G, C7]			1,310.00
F 026 400 342	Air Filter Element, Engine		SKODA- Octavia [5E3] (P) 103 Kw (2013.10 -2015.05)			On Request
F 026 400 342	Air Filter Element, Engine		VOLKSWAGEN- Beetle [5C1]	04E129620		On Request
F 026 400 343	Air Filter Element, Engine		DACIA- Lodgy [JS]	165467674R		On Request
F 026 400 344	Air Filter Element, Engine		TOYOTA- Fortuner [N5,N6], Innova 2.0i, Innova 2.0 CNG (P+GAS) 100 Kw (2009.02 -2013.05), Innova 2.0, Innova 2.5 CRDi (D) 75 Kw (2004.12 -2019.01), Fortuner 3.0 Diesel Turbo, Fortuner 2.5 D-4D	178010C030, 178010C010, 178010C020		On Request
F 026 400 346	Air Filter Element, Engine		FIAT- Punto Evo [199] (D) 68 Kw (2009.10 -2011.12), Punto Evo [199] (D) 56 Kw (2010.05 -2011.12)	6000633306		On Request
F 026 400 360	Air Filter Element, Engine		BMW Mini- Mini [F 57] Cabrio, Mini [F 56], Mini [F 54] Clubman			On Request
F 026 400 360	Air Filter Element, Engine		BMW- 2 [F 44] Gran Coupe, X 1 [F 48]	13718513944		On Request

### Filter Application Chart









Part Number	Product Description	Image	Model Description 	Potential OE Part No	Potential Comp. Part No	MRP (₹)
F 026 400 365	Air Filter Element, Engine		BMW- 5 [F 10] (D) 160 Kw (2011.09 -2016.10), 5 [F 10] (D) 150 Kw (2010.03 -2011.08), 5 [F 07] GT, 5 [F 10] (D) 180 Kw (2010.03 -2011.08), 7 [F 02], 5 [F 10] (D) 100 Kw (2010.05 -2016.10)	13717800151		4,175.00
F 026 400 366	Air Filter Element, Engine		BMW- X 5 [E 70] (D) 155 Kw (2010.04 -2013.06), X 6 [E 71], X 3 [F 25]	13717811026		4,223.00
F 026 400 374	Air Filter Element, Engine		BMW- 3 [F 30] (P) 160 Kw (2012.02 -2015.08), 3 [F 30] (P) 135 Kw (2012.03 -2018.10), 3 [F 30] (D) 135 Kw (2012.02 -2016.03), 3 [F 34] GT, 1 [F 20]	13718511668		1,751.00
F 026 400 379	Air Filter Element, Engine		MERCEDES-BENZ- GLA-Klasse [156], CLA-Klasse [117], B-Klasse [246], A-Klasse [176]	6510940204		1,020.00
F 026 400 388	Air Filter Element, Engine		MERCEDES-BENZ- S-Klasse [221] (D) 173 Kw (2005.12 -2009.04), R-Klasse [251] (D) 140 Kw (2009.05 -2010.05), E-Klasse [211] (D) 140 Kw (2005.09 -2008.12), E-Klasse [211] (D) 145 Kw (2006.01 -2009.08), CLS-Klasse [219] (D) 155 Kw (2005.05 -2009.04), S-Klasse [221] (D) 173 Kw (2009.05 -2013.12), GL-Klasse [164] (D) 165 Kw (2009.05 -2010.08), M-Klasse [164] (D) 140 Kw (2009.05 -2010.12)	6420942804		On Request
F 026 400 389	Air Filter Element, Engine		MERCEDES-BENZ- S-Klasse [221] (D) 173 Kw (2005.12 -2009.04), R-Klasse [251] (D) 140 Kw (2009.05 -2010.05), E-Klasse [211] (D) 140 Kw (2005.09 -2008.12), E-Klasse [211] (D) 145 Kw (2006.01 -2009.08), CLS-Klasse [219] (D) 155 Kw (2005.05 -2009.04), S-Klasse [221] (D) 173 Kw (2009.05 -2013.12), GL-Klasse [164] (D) 165 Kw (2009.05 -2010.08), M-Klasse [164] (D) 140 Kw (2009.05 -2010.12)	6420943004		On Request













### Filter Application Chart

Part Number	Product Description	Image	Model Description 	Potential OE Part No	Potential Comp. Part No	MRP (₹)
F 026 400 391	Air Filter Element, Engine		SKODA- Fabia [5J2, 542] (D) 55 Kw (2010.03 -2014.12), Fabia [5J2, 542] (P) 63 Kw (2010.03 -2014.12)			875.00
F 026 400 391	Air Filter Element, Engine		VOLKSWAGEN- Vento 1.5 TDI HIGHLINE, POLO BS-VI, Polo [6R1], VENTO BS-VI, Ameo BS-VI	6RF129620, 6R0129620A		875.00
F 026 400 415	Air Filter Element, Engine		LEXUS- ES [V6]			On Request
F 026 400 422	Air Filter Element, Engine		AUDI- A4 [8W2, 8WC, B9] (D) 140 Kw (2017.02 -2018.06)			On Request
F 026 400 423	Air Filter Element, Engine		LAND ROVER GROUP- Evoque [LV,L538], Discovery Sport [LC,L550]	LR071942	JAG -T2H8107	On Request
F 026 400 425	Air Filter Element, Engine		AUDI- A4 [8W2, 8WC, B9] (P) 110 Kw (2015.08 -2019.10)			On Request
F 026 400 433	Air Filter Element, Engine		CITROEN- C5 Aircross [C84]	9800097580		On Request
F 026 400 456	Air Filter Element, Engine		LEXUS- RX			On Request
F 026 400 463	Air Filter Element, Engine		BMW- X 3 [E 83] (P) 160 Kw (2006.09 -2008.08)	13717542545		On Request

### Filter Application Chart

Part Number	Product Description	Image	Model Description 	Potential OE Part No	Potential Comp. Part No	MRP (₹)
F 026 400 468	Air Filter Element, Engine		MERCEDES-BENZ- C-Klasse [205] (D) 110 Kw (2018.10-->), E-Klasse [213], GLS-Klasse [167], S-Klasse [223], GLE-Klasse [167], GLC-Klasse [253] (D) 180 Kw (2019.04 -2022.05), G-Klasse [463] (D) 210 Kw (2019.01-->)	6540940004		On Request
F 026 400 480	Air Filter Element, Engine		MERCEDES-BENZ- C-Klasse [205] (P) 135 Kw (2013.12 -2019.02), GLC-Klasse [253] (P) 180 Kw (2016.05 -2019.03), E-Klasse [212] (P) 135 Kw (2012.08 -2016.08)	2740940004		On Request
F 026 400 508	Air Filter Element, Engine		BMW- 5 [F 10] (P) 412 Kw (2011.09 -2016.10), M 4 [F 82], M 3 [F 80], M 2 [F 87], 6 [F 14] Gran Coupe	13727843283		On Request
F 026 400 513	Air Filter Element, Engine		VOLVO- XC60 I [156], V60 [155], S80 II [124] (D) 136 Kw (2006.03 -2009.07), S80 II [124] (D) 120 Kw (2012.08 -2016.08), S60 II [134], S60 [134] Cross Country			On Request
F 026 400 549	Air Filter Element, Engine		BMW Mini- Mini [R 56] (P) 85 Kw (2010.03 -2013.11), Mini [R 57] Cabrio (P) 85 Kw (2010.03 -2015.06), Mini [R 60] Countryman (P) 85 Kw (2010.09 -2016.10)			On Request
F 026 400 558	Air Filter Element, Engine		HYUNDAI- Elite i20 [IB], i20 [IB] Active, i20 [BC3], i20 [GB]	28113C8000		On Request
F 026 400 593	Air Filter Element, Engine		MERCEDES-BENZ- A-Klasse [177] Limousine, GLA-Klasse [247]	2820940004		On Request
F 026 400 600	Air Filter Element, Engine		MERCEDES-BENZ- A-Klasse [177]	6540940204		On Request











### Filter Application Chart

Part Number	Product Description	Image	Model Description 	Potential OE Part No	Potential Comp. Part No	MRP (₹)
F 026 400 629	Air Filter Element, Engine		AUDI- A8 [4E, D3]			On Request
F 026 400 650	Air Filter Element, Engine		AUDI- A5 [8F7] Cabriolet			On Request
F 026 400 674	Air Filter Element, Engine		LEXUS- ES [Z]			On Request
F 026 400 677	Air Filter Element, Engine		AUDI- S5 [F5A, F5F] Sportback			On Request
F 026 400 692	Air Filter Element, Engine		BMW- 3 [G 20]	13718580429		On Request
F 026 400 699	Air Filter Element, Engine		JAGUAR- F-Pace [X761] (P) 280 Kw (2015.09 -2020.08), F-Pace [X761] (P) 405 Kw (2020.09-->)	T4A6123	LRG -LR092246	On Request
F 026 400 712	Air Filter Element, Engine		MERCEDES-BENZ- M-Klasse [166], E-Klasse [212] (P) 410 Kw (2011.04 -2015.08), GLS-Klasse [166], S-Klasse [217] Coupe, S-Klasse [217] Cabrio, S-Klasse [222], GL-Klasse [166], CLS-Klasse [218] Coupe	2780940004		On Request
F 026 400 713	Air Filter Element, Engine		BMW- 5 [G 30], 7 [G 12]	13718577171		On Request
F 026 400 738	Air Filter Element, Engine		RENAULT- Koleos [HY]	165463205R		On Request

### Filter Application Chart

Part Number	Product Description	Image	Model Description 	Potential OE Part No	Potential Comp. Part No	MRP (₹)
F 026 400 755	Air Filter Element, Engine		PORSCHE- 911 [991], 911 [991] Cabriolet	99111013000		On Request
F 002 H23 584	Air Filter, Complete, Engine		MAHINDRA- Bolero 2.5 Diesel	0313AC0280N, 0313AAM01480N		793.00
0 986 AF5 529	Cabin Filter		HYUNDAI- Accent 1.5 CRDi, Getz 1.5 CRDi 16V, Getz 1.3 i, Getz 1.1 i	976171C001		On Request
1 987 432 012	Cabin Filter		SKODA- Superb [3U4], Octavia [1U2], Octavia [1U5] Combi			385.00
1 987 432 012	Cabin Filter		VOLKSWAGEN- Polo 1.5 TD, Passat 1.8i	1J0819644A		385.00
1 987 432 051	Cabin Filter		MERCEDES-BENZ- E-Klasse [124]	1248350047		2,817.00
1 987 432 057	Cabin Filter		SKODA- Rapid 1.6D, Fabia 1.6 i, Fabia [5J2, 542]			712.00
1 987 432 057	Cabin Filter		MAHINDRA- Scorpio 2.2TD 4x4, XYLO 2.2 TD mHawk, Scorpio 2.6 CRDe, Quanto 1.5D, XYLO 2.5 TD MDI, Scorpio 2.2 TD 4WD, XYLO 2.5 TD mEagle, Scorpio 1.9TD 4x4, Scorpio 2.5D	1203CA2120N, 1203CAA02621N, 1203CAA02820N		712.00
1 987 432 057	Cabin Filter		VOLKSWAGEN- Polo [6R1]	6Q0820367B		712.00

### Filter Application Chart











Part Number	Product Description	Image	Model Description 	Potential OE Part No	Potential Comp. Part No	MRP (₹)
1 987 432 070	Cabin Filter		MERCEDES-BENZ- C 220 CDI	2038300118		945.00
1 987 432 072	Cabin Filter		FIAT- Punto '03 [188], Linea 1.4 i.e. 16V, Linea 1.3 Diesel Classic, Punto 1.2D, Punto 1.4i	59116510, 59064502, 46723331		422.00
1 987 432 073	Cabin Filter		FORD- Mondeo III, Mondeo '01 [B4Y]			979.00
1 987 432 075	Cabin Filter		LEXUS- RX			On Request
1 987 432 081	Cabin Filter		MERCEDES-BENZ- 124-Serie [124], CLS-Klasse [219]	2118300218		1,115.00
1 987 432 084	Cabin Filter		TOYOTA- Fortuner [N5,N6] (D) 120 Kw (2005.01 -2012.04)			785.00
1 987 432 085	Cabin Filter		TOYOTA- Land Cruiser Prado [J12]	8713947010		927.00
1 987 432 097	Cabin Filter		AUDI- A3 [8PA] Sportback, TT [8J3] Coupe, Q3 [8U]			785.00
1 987 432 097	Cabin Filter		VOLKSWAGEN- Passat [362], Passat [3C2], Beetle [5C1], Jetta [162]; SKODA- Laura 2.0 TDI, Laura, Superb [3T4], Laura 1.9 TDI, Yeti [5L7]	1K0819644B		785.00

### Filter Application Chart











Part Number	Product Description	Image	Model Description 	Potential OE Part No	Potential Comp. Part No	MRP (₹)
1 987 432 116	Cabin Filter		LAND ROVER GROUP- Freelander [LN, L314] (D) 140 Kw (2013.03 -2015.09)			On Request
1 987 432 132	Cabin Filter		HYUNDAI- i20 1.2i 16V, i20 1.2i	971331J000, 971331J500		1,730.00
1 987 432 164	Cabin Filter		HYUNDAI- Eon 1.0 Magna Plus, i10 [PA], i10 [IA], i10 1.1 i, Eon LPG 0.8, i10 1.1 CNG	9713307010, 971330X900		On Request
1 987 432 171	Cabin Filter		CHEVROLET- Spark 1.0 LPG/CNG, Spark 1.0 i	96425700, J96425700		1,205.00
1 987 432 188	Cabin Filter		FIAT- Linea [323] (P) 88 Kw (2007.03 -2017.12), Punto Evo [199]	55702456		On Request
1 987 432 190	Cabin Filter		LAND ROVER GROUP- Range Rover IV [LG,L405], Range Rover Sport [LW,L494]; LEXUS- ES [V6], LX [J2]			745.00
1 987 432 190	Cabin Filter		TOYOTA- Prius [W30], Fortuner 3.0 Diesel Turbo, Fortuner [N5,N6] (D) 120 Kw (2005.01 -2012.04), Corolla [E15]	8713906080, 87139YZZ16		745.00
1 987 432 190	Cabin Filter		JAGUAR- XF [X260], XE [X760], F-Pace [X761], XF Sportbrake [X260], I-Pace [X590]	T2H8151		745.00
1 987 432 200	Cabin Filter		PORSCHE- 911 [997], Boxster [987], Cayman [987C]			On Request











### Filter Application Chart

Part Number	Product Description	Image	Model Description 	Potential OE Part No	Potential Comp. Part No	MRP (₹)
1 987 432 210	Cabin Filter		LAND ROVER GROUP- Freelander [LN, L314] (D) 140 Kw (2013.03 -2015.09)			On Request
1 987 432 214	Cabin Filter		MARUTI- Ritz 1.2 Generation I			1,300.00
1 987 432 228	Cabin Filter		FIAT- Linea [323] (P) 88 Kw (2007.03 -2017.12)	77364561		On Request
1 987 432 234	Cabin Filter		HONDA- Jazz [2TF]	80292TF0G01, 80291TF0E01		On Request
1 987 432 242	Cabin Filter		BMW- X 3 [F 25]	64319312316, 64312284827		On Request
1 987 432 246	Cabin Filter		NISSAN- Micra [K13K], Sunny 1.5D, Micra 1.2 i	272771HD0B, 272771HDOC, 272771HD0A, 272771HA0A		765.00
1 987 432 247	Cabin Filter		RENAULT- Fluence [L3]	272772100R		On Request
1 987 432 296	Cabin Filter		BMW Mini- Mini [R 60] Countryman, Mini [R 56], Mini [R 57] Cabrio			On Request
1 987 432 540	Cabin Filter		AUDI- A3 [8VS, 8VM] Limousine, Q2 [GAB, GAG], TT [FV3, FVP] Coupe, A3 [8V1, 8VK], A3 [8V7, 8VE] Cabriolet; SKODA- Octavia [5E3], Kodiaq [NS], Superb [3V3]			On Request

### Filter Application Chart

Part Number	Product Description	Image	Model Description 	Potential OE Part No	Potential Comp. Part No	MRP (₹)
1 987 432 540	Cabin Filter		VOLKSWAGEN- Tiguan [AD1]	5Q0819644A		On Request
1 987 435 005	Cabin Filter		FIAT- 500 [312]	51854923		On Request
1 987 435 018	Cabin Filter		VOLVO- V40 [526] Cross Country			On Request
1 987 435 026	Cabin Filter		CITROEN- C5 Aircross [C84]			On Request
1 987 435 053	Cabin Filter		MERCEDES-BENZ- E-Klasse [211]	2118301218		On Request
1 987 435 058	Cabin Filter		MERCEDES-BENZ- EQC-Klasse [293], E-Klasse [213], C-Klasse [205], GLS-Klasse [166], GLC-Klasse [253], GLE-Klasse [166], GLC-Klasse [253] Coupe, GL-Klasse [166]	1668300218		2,322.00
1 987 435 061	Cabin Filter		VOLVO- S80 I [184], S60 I [384], XC90 I [275]			On Request
1 987 435 064	Cabin Filter		ROLLS-ROYCE- Wraith [RR5], Dawn [RR6], Ghost [RR4]			On Request
1 987 435 064	Cabin Filter		BMW- 6 [F 06] Gran Coupe, 6 [F 12] Cabrio, 5 [F 07] GT, 5 [F 10], 7 [F 02], 6 [F 14] Gran Coupe, 6 [F 13] Coupe	64119272641		On Request











### Filter Application Chart

Part Number	Product Description	Image	Model Description 	Potential OE Part No	Potential Comp. Part No	MRP (₹)
1 987 435 079	Cabin Filter		JEEP- Grand Cherokee [WK2]			On Request
1 987 435 117	Cabin Filter		LAND ROVER GROUP- Range Rover III [LM,L322]			On Request
1 987 435 143	Cabin Filter		MERCEDES-BENZ- A-Klasse [177] Limousine, A-Klasse [177], GLA-Klasse [247]	2478300900		On Request
1 987 435 163	Cabin Filter		MERCEDES-BENZ- GLS-Klasse [167], GLE-Klasse [167]	1678350200		On Request
1 987 435 517	Cabin Filter		NISSAN- X-Trail [T30]	272774M425		On Request
F 002 H24 938	Cabin Filter		MARUTI- Alto 1.0i, Alto 1.0 CNG/LPG, A-Star 1.0i 12V			335.00
F 002 H24 939	Cabin Filter		SUZUKI- Baleno 1.3 TD			450.00
F 002 H24 939	Cabin Filter		MARUTI- Dzire 1.2, SX4 1.6i, Dzire BS IV, Celerio 1.0 VXi Green CNG, Swift 1.3 TD, Ertiga 1.4 CNG Generation I, Swift 1.3 Dzire TD, S-cross 1.2 (D) 66 Kw (2015.08-->), Swift 1.2, Swift 1.2i, Swift 1.2i Dzire, Baleno 1.2, Swift BS IV, Ertiga 1.3 TD Generation I, Dzire Tour S CNG 1.2, Ertiga 1.4 Generation I, Ciaz 1.3 TD	95850M55R00, 95861M74L00, 95850M79M00		450.00

### Filter Application Chart

Part Number	Product Description	Image	Model Description 	Potential OE Part No	Potential Comp. Part No	MRP (₹)
F 002 H24 940	Cabin Filter		SUZUKI- S-Cross 1.6 TD, S-Cross 1.3 TD			480.00
F 002 H24 940	Cabin Filter		MARUTI- S-cross 1.2 (D) 66 Kw (2015.08-->), Vitara Brezza 1.2, S-cross 1.6 TD 2WD, Ciaz 1.4 Generation I	95850M79M00		480.00
F 002 H24 941	Cabin Filter		TOYOTA- Innova 2.0i, Innova 2.5 CRDi, Innova 2.0, Innova 2.0 CNG, Fortuner 2.5 D-4D	8713906080		438.00
F 002 H24 942	Cabin Filter		MARUTI- Ignis 1.2, Ignis 1.3 TD	95850M66RC0		375.00
F 002 H24 943	Cabin Filter		MARUTI- Wagon R 1.0i LPG, Wagon R 1.1i 16V			512.00
F 002 H24 944	Cabin Filter		HYUNDAI- Creta 1.4 TD, Creta 1.6, Elantra 2.0, Elantra 1.6 TD, Elantra 1.8 i, Elantra 2.0 CRDi, Creta 1.6 CRDi	971332D900, 97133F2000, 971332H001, 97133A0000		515.00
F 002 H24 945	Cabin Filter		HYUNDAI- Elite i20 1.4, Elite i20 [IB], i20 Active 1.2	97133C7100		590.00
F 002 H24 946	Cabin Filter		HYUNDAI- Verna 1.6i 16V, Verna 1.5 CRDi, Verna 1.6i, Verna 1.4D, Verna 1.6D, Verna 1.4 i	971330M000, 971334L000		590.00
F 002 H24 948	Cabin Filter		NISSAN- Terrano 1.6, Terrano 1.5 D	8201153808, 272773223R		378.00

### Filter Application Chart











Part Number	Product Description	Image	Model Description 	Potential OE Part No	Potential Comp. Part No	MRP (₹)
F 002 H24 948	Cabin Filter		RENAULT- Duster 1.6, Duster 1.5 TD	8201153808, 272775374R, 7701062227, 272773223R		378.00
F 002 H24 983	Cabin Filter		TOYOTA- Etios Cross 1.2 G, Etios 1.4D Liva, Etios 1.5i, Etios 1.5 Liva, Etios Cross 1.5 V, Etios 1.4D, Etios 1.2i Liva, Etios Cross 1.4TD	871390D060, 871390D190		284.00
F 002 H24 984	Cabin Filter		MAHINDRA- XUV500 2.2D, XUV500 1.9TD, XUV500 2.2 W9, XUV500 2.2D 4x4	1203CAA03680N		1,038.00
F 002 H26 399	Cabin Filter		FORD- Fusion 1.6i 16V, Fiesta 1.4 Turbodiesel, Figo 1.4D, Fusion 1.4 Diesel 8V, Fiesta 1.6i, Fiesta 1.4i, Fiesta 1.5 Turbodiesel, Figo [B517]			285.00
0 986 AF5 529	Cabin Filter Micro Clean		HYUNDAI- Getz 1.1 i	976171C001		On Request
0 986 AF5 531	Cabin Filter Micro Clean		HYUNDAI- Sonata 2.0 CRDi, Sonata [NF] (P) 129 Kw (2009.01 -2011.12), Santa Fe [CM] (D) 110 Kw (2006.03 -2009.11)			On Request
0 986 AF5 541	Cabin Filter Micro Clean		HYUNDAI- i10 1.1 i			On Request
0 986 AF5 562	Cabin Filter Micro Clean		HYUNDAI- Sonata [NF] (P) 129 Kw (2009.01 -2011.12), Santa Fe [CM] (D) 110 Kw (2006.03 -2009.11)			On Request
1 987 432 171	Cabin Filter Micro Clean		CHEVROLET- Spark 1.0 LPG/CNG	96425700, J96425700		1,205.00

### Filter Application Chart











Part Number	Product Description	Image	Model Description 	Potential OE Part No	Potential Comp. Part No	MRP (₹)
F 002 H26 399	Cabin Filter Micro Clean		FORD- Fusion 1.6i 16V, Fiesta 1.4 Turbodiesel, Fiesta 1.5i, Fiesta 1.5 Turbodiesel, Figo Aspire 1.5 TDCi, EcoSport 1.5 TD, Figo Aspire 1.5 Ti-VCT, EcoSport 1.5			285.00
1 987 432 300	Cabin Filter, Activated Carbon		SKODA- Octavia [1U2] (P) 110 Kw (1998.03 -2010.12), Octavia [1U2] (D) 66 Kw (2001.11 -2009.12), Octavia [1U5] Combi (D) 66 Kw (1998.05 -2009.12), Octavia [1U2] (P) 85 Kw (2000.08 -2005.01); AUDI- TT [8N3] Coupe			1,082.00
1 987 432 300	Cabin Filter, Activated Carbon		VOLKSWAGEN- New Beetle [1C1, 9C1]	1J0819644A		1,082.00
1 987 432 312	Cabin Filter, Activated Carbon		SKODA- Octavia [1U2] (P) 110 Kw (1998.03 -2010.12), Superb [3U4], Octavia [1U2] (D) 66 Kw (2001.11 -2009.12), Octavia [1U5] Combi (D) 66 Kw (1998.05 -2009.12), Octavia [1U2] (P) 85 Kw (2000.08 -2005.01)			1,240.00
1 987 432 312	Cabin Filter, Activated Carbon		VOLKSWAGEN- Polo 1.5 TD, Vento 1.2, POLO, Vento 1.6 D, Vento 1.6 i, Ameo 1.5TDi, Vento 1.5 TDi, Polo 1.5 TDi, Ameo 1.0, Cross Polo 1.2, Vento 1.5 TD, Passat 1.8i, Polo 1.5 TDI, Ameo 1.2	6R0820367		1,240.00
1 987 432 336	Cabin Filter, Activated Carbon		BMW- X 3 [E 83]	64319216590		On Request
1 987 432 357	Cabin Filter, Activated Carbon		SKODA- Fabia [5J2, 542] (D) 51 Kw (2007.02 -2010.03), Fabia [5J2, 542] (D) 55 Kw (2010.03 -2014.12), Fabia [5J2, 542] (P) 63 Kw (2010.03 -2014.12), Fabia [5J2, 542] (P) 63 Kw (2007.01 -2010.03), Fabia [5J2, 542] (P) 44 Kw (2006.12 -2009.05)			1,188.00
1 987 432 357	Cabin Filter, Activated Carbon		VOLKSWAGEN- Polo [6R1] (D) 77 Kw (2013.09 -2014.06), Polo [6R1] (D) 55 Kw (2013.09 -2014.09), Polo [6R1] (P) 77 Kw (2013.04 -2014.05)	6Q0819653B		1,188.00













### Filter Application Chart

Part Number	Product Description	Image	Model Description 	Potential OE Part No	Potential Comp. Part No	MRP (₹)
1 987 432 368	Cabin Filter, Activated Carbon		BMW- Z 4 [E 89]	64319195194		On Request
1 987 432 369	Cabin Filter, Activated Carbon		AUDI- S5 [8F7] Cabriolet, S4 [8K2, B8], Q5 [8RB], A5 [8F7] Cabriolet, Q5 2.0 TDI quattro, RS5 [8T3] Coupe, A4 [8K2, B8]			1,665.00
1 987 432 369	Cabin Filter, Activated Carbon		PORSCHE- Macan [95B]	8K0819439B		1,665.00
1 987 432 371	Cabin Filter, Activated Carbon		AUDI- A4 [8EC, B7], A4 [8E2, B6]			On Request
1 987 432 402	Cabin Filter, Activated Carbon		BMW- 5 [E 60], 6 [E 63], 6 [E 64] Cabrio	64319171858		On Request
1 987 432 405	Cabin Filter, Activated Carbon		VOLVO- S80 II [124], XC60 I [156], V60 [155], S60 II [134], S60 [134] Cross Country		JAG -C2Z32298	5,470.00
1 987 432 405	Cabin Filter, Activated Carbon		LAND ROVER GROUP- Evoque [LV,L538], Freelander [L359], Discovery Sport [LC,L550]	LR056138	JAG -C2Z32298	5,470.00
1 987 432 407	Cabin Filter, Activated Carbon		PORSCHE- 911 [997], Boxster [987], Cayman [987C]	99757121901		On Request
1 987 432 415	Cabin Filter, Activated Carbon		FORD- EcoSport '14 [JK8]			On Request

### Filter Application Chart

Part Number	Product Description	Image	Model Description 	Potential OE Part No	Potential Comp. Part No	MRP (₹)
1 987 432 419	Cabin Filter, Activated Carbon		BMW- X 5 M [F 85], X 5 [E 70], X 5 [F 15], X 6 [E 71], X 6 M [F 86], X 6 [F 16]	64119248294		On Request
1 987 432 422	Cabin Filter, Activated Carbon		AUDI- A6 [AU561], R8 [423], A6 [4F2, C6], A6 [4FH, C6] Allroad, R8 [429] Spyder			On Request
1 987 432 424	Cabin Filter, Activated Carbon		BMW- 3 [E 90], X 1 [E 84], 3 [E 93] Cabrio (D) 180 Kw (2009.03 -2013.09)	64319313519		1,950.00
1 987 432 425	Cabin Filter, Activated Carbon		LAND ROVER GROUP- Range Rover III [LM,L322]	LR161567		On Request
1 987 432 431	Cabin Filter, Activated Carbon		AUDI- Q7 [4LB]			985.00
1 987 432 431	Cabin Filter, Activated Carbon		VOLKSWAGEN- Touareg [7LA]	7H0819631A		985.00
1 987 432 431	Cabin Filter, Activated Carbon		PORSCHE- Cayenne [9PA]	95581963100		985.00
1 987 432 438	Cabin Filter, Activated Carbon		MERCEDES-BENZ- CL-Klasse [216], S-Klasse [221]	2218300718		On Request
1 987 432 531	Cabin Filter, Activated Carbon		VOLVO- S80 I [184], S60 I [384], XC90 I [275]			On Request





### Filter Application Chart

Part Number	Product Description	Image	Model Description 	Potential OE Part No	Potential Comp. Part No	MRP (₹)
1 987 432 537	Cabin Filter, Activated Carbon		FIAT- Punto Evo [199], Linea [323]	77365764		On Request
1 987 432 542	Cabin Filter, Activated Carbon		BMW- X 3 [F 25]	64319312318, 64312284828		On Request
1 987 432 548	Cabin Filter, Activated Carbon		BENTLEY- Mulsanne [3Y]; AUDI- RS7 [4G, C7] Sportback, A6 [4G, C7], S6 [4G, C7], RS6 [4G, C7] Avant, A7 [4G, C7] Sportback, A8 [4H, D4]			On Request
1 987 432 568	Cabin Filter, Activated Carbon		JAGUAR- XJ [X351], XF [X250]	C2Z6525		On Request
1 987 432 571	Cabin Filter, Activated Carbon		MERCEDES-BENZ- SLC-Klasse [172], SLK-Klasse [172], SLK-Klasse [171]	1728350047, 1718300418		On Request
1 987 432 597	Cabin Filter, Activated Carbon		AUDI- A3 [8PA] Sportback, TT [8J3] Coupe, Q3 [8U]; SKODA- Laura, Superb [3T4], Yeti [5L7]			On Request
1 987 432 597	Cabin Filter, Activated Carbon		VOLKSWAGEN- Passat [362], Passat [3C2], Beetle [5C1], Jetta [162]	1K2819653B		On Request
1 987 435 001	Cabin Filter, Activated Carbon		MERCEDES-BENZ- C-Klasse [204], SLS-Klasse [197] Coupe, E-Klasse [207] Cabrio, E-Klasse [212], CLS-Klasse [218] SB, AMG GT [190] Roadster, CLS-Klasse [218] Coupe, E-Klasse [207] Coupe	2128300318		1,900.00
1 987 435 501	Cabin Filter, Activated Carbon		RENAULT- Logan [KS/FS] MCV, Duster dCi, Duster [HS]; DACIA- Duster [HS]	7711426872		On Request











### Filter Application Chart

Part Number	Product Description	Image	Model Description 	Potential OE Part No	Potential Comp. Part No	MRP (₹)
1 987 435 502	Cabin Filter, Activated Carbon		SKODA- Fabia [5J2, 542] (D) 55 Kw (2010.03 -2014.12), Fabia [5J2, 542] (P) 63 Kw (2010.03 -2014.12)			On Request
1 987 435 502	Cabin Filter, Activated Carbon		VOLKSWAGEN- Polo [6R1] (D) 77 Kw (2013.09 -2014.06), Polo [6R1] (D) 55 Kw (2013.09 -2014.09), Polo [6R1] (P) 77 Kw (2013.04 -2014.05)	6R0819653		On Request
1 987 435 505	Cabin Filter, Activated Carbon		MERCEDES-BENZ- GLA-Klasse [156], CLA-Klasse [117], B-Klasse [246], A-Klasse [176]	2468300018		On Request
1 987 435 508	Cabin Filter, Activated Carbon		MERCEDES-BENZ- SL-Klasse [230]	2308300418		On Request
1 987 435 509	Cabin Filter, Activated Carbon		JAGUAR- F-Type Cabriolet [X152], F-Type Coupe [X152], XK [X150] Convertible, XK [X150] Coupe	C2P2410	KNE -LAK364	On Request
1 987 435 512	Cabin Filter, Activated Carbon		VOLKSWAGEN- Touareg [7P5]	7P0819631		On Request
1 987 435 512	Cabin Filter, Activated Carbon		PORSCHE- Cayenne [92A]	95857221901		On Request
1 987 435 522	Cabin Filter, Activated Carbon		CITROEN- C5 Aircross [C84]	6447XG		On Request
1 987 435 538	Cabin Filter, Activated Carbon		BMW Mini- Mini [F 54] Clubman (P) 120 Kw (2015.10 -2018.06), Mini [F 56] (P) 120 Kw (2014.03 -2018.06), Mini [F 56] (D) 85 Kw (2014.03 -2018.02)			On Request

### Filter Application Chart











Part Number	Product Description	Image	Model Description 	Potential OE Part No	Potential Comp. Part No	MRP (₹)
1 987 435 538	Cabin Filter, Activated Carbon		BMW- X 1 [F 48] (P) 141 Kw (2017.05 -2018.03), X 1 [F 48] (D) 120 Kw (2015.10 -2019.07), X 1 [F 48] (D) 120 Kw (2015.11 -2019.07)	64116823725		On Request
1 987 435 546	Cabin Filter, Activated Carbon		MERCEDES-BENZ- S-Klasse [217] Coupe, S-Klasse [222] Maybach, S-Klasse [217] Cabrio, S-Klasse [222]	2228300418, 2228300318		On Request
1 987 435 574	Cabin Filter, Activated Carbon		RENAULT- Fluence [L3]	272774936R		On Request
1 987 435 582	Cabin Filter, Activated Carbon		BMW Mini- Mini [F 57] Cabrio, Mini [F 54] Clubman (P) 120 Kw (2015.10 -2018.06), Mini [F 56] (P) 155 Kw (2017.09 -2018.03), Mini [F 56] (P) 120 Kw (2014.03 -2018.06), Mini [F 56] (D) 85 Kw (2014.03 -2018.02)			On Request
1 987 435 582	Cabin Filter, Activated Carbon		BMW- X 1 [F 48] (D) 140 Kw (2017.11-->), X 1 [F 48] (P) 141 Kw (2017.05 -2018.03), X 1 [F 48] (D) 120 Kw (2015.10 -2019.07), 2 [F 44] Gran Coupe, X 1 [F 48] (D) 120 Kw (2015.11 -2019.07), X 1 [F 48] (P) 141 Kw (2019.09-->)	64316835405, 64316835406		On Request
1 987 435 585	Cabin Filter, Activated Carbon		MERCEDES-BENZ- M-Klasse [164], R-Klasse [251], GL-Klasse [164]	1648300218		2,643.00
1 987 435 587	Cabin Filter, Activated Carbon		BMW- 3 [E 93] Cabrio (P) 309 Kw (2008.03 -2013.10), 3 [E 92] Coupe	64319159606		On Request
1 987 435 589	Cabin Filter, Activated Carbon		FIAT- 500 [312]	71775823		On Request

### Filter Application Chart











Part Number	Product Description	Image	Model Description 	Potential OE Part No	Potential Comp. Part No	MRP (₹)
1 987 435 590	Cabin Filter, Activated Carbon		LEXUS- ES [Z]			On Request
1 987 435 592	Cabin Filter, Activated Carbon		NISSAN- X-Trail [T30]			On Request
1 987 435 601	Cabin Filter, Activated Carbon		MERCEDES-BENZ- EQC-Klasse [293], C-Klasse [205], E-Klasse [213], GLC-Klasse [253], GLC-Klasse [253] Coupe	2058350147		On Request
1 987 435 604	Cabin Filter, Activated Carbon		BMW- 3 [G 20]	64119382886		On Request
1 987 435 609	Cabin Filter, Activated Carbon		MERCEDES-BENZ- A-Klasse [177] Limousine, A-Klasse [177], GLA-Klasse [247]	2478307203		On Request
1 987 435 617	Cabin Filter, Activated Carbon		MERCEDES-BENZ- GLS-Klasse [167], GLE-Klasse [167]	1678350400		On Request
1 987 435 618	Cabin Filter, Activated Carbon		MERCEDES-BENZ- M-Klasse [166], GLS-Klasse [166], GLE-Klasse [166], GL-Klasse [166]	1668307201		On Request
1 987 435 623	Cabin Filter, Activated Carbon		BMW- i 8 [I 12]	64319346267		On Request
0 986 AF4 431	Cabin Filter, Activated Carbon Aeristo Extra		LEXUS- NX 300h 4WD			On Request













### Filter Application Chart

Part Number	Product Description	Image	Model Description 	Potential OE Part No	Potential Comp. Part No	MRP (₹)
0 986 628 502	Cabin Filter, Activated Carbon+		RENAULT- Logan [KS/FS] MCV, Duster dCi, Duster [HS]; DACIA- Duster [HS]	8201370532		On Request
0 986 628 519	Cabin Filter, Activated Carbon+		LEXUS- RX			On Request
0 986 628 558	Cabin Filter, Activated Carbon+		ROLLS-ROYCE- Wraith [RR5], Dawn [RR6], Ghost [RR4]			On Request
0 986 628 558	Cabin Filter, Activated Carbon+		BMW- 6 [F 06] Gran Coupe, 6 [F 12] Cabrio, 5 [F 07] GT, 5 [F 10], 7 [F 02], 6 [F 14] Gran Coupe, 6 [F 13] Coupe	64116809933		On Request
0 986 628 559	Cabin Filter, Activated Carbon+		BENTLEY- Mulsanne [3Y]; AUDI- RS7 [4G, C7] Sportback, A6 [4G, C7], S6 [4G, C7], RS6 [4G, C7] Avant, A7 [4G, C7] Sportback, A8 [4H, D4]			On Request
0 986 628 560	Cabin Filter, Activated Carbon+		MERCEDES-BENZ- M-Klasse [164], R-Klasse [251], GL-Klasse [164]			On Request
0 986 628 561	Cabin Filter, Activated Carbon+		VOLVO- S80 II [124], XC60 I [156], V60 [155], S60 II [134], S60 [134] Cross Country		JAG -J9C11886	On Request
0 986 628 561	Cabin Filter, Activated Carbon+		LAND ROVER GROUP- Evoque [LV,L538], Freelander [L359], Discovery Sport [LC,L550]	VPLFS0488	JAG -J9C11886	On Request
0 986 628 608	Cabin Filter, Activated Carbon+		BMW- 3 [E 90], X 1 [E 84], 3 [E 93] Cabrio	64316803970		On Request





### Filter Application Chart

Part Number	Product Description	Image	Model Description 	Potential OE Part No	Potential Comp. Part No	MRP (₹)
0 986 628 622	Cabin Filter, Activated Carbon+		AUDI- S5 [8F7] Cabriolet, S4 [8K2, B8], Q5 [8RB], A5 [8F7] Cabriolet, RS5 [8T3] Coupe, A4 [8K2, B8]; PORSCHE- Macan [95B]			On Request
0 986 628 630	Cabin Filter, Activated Carbon+		AUDI- A3 [8VS, 8VM] Limousine, Q2 [GAB, GAG], TT [FV3, FVP] Coupe, A3 [8V1, 8VK], A3 [8V7, 8VE] Cabriolet; SKODA- Octavia [5E3], Kodiaq [NS], Superb [3V3]			On Request
0 986 628 630	Cabin Filter, Activated Carbon+		VOLKSWAGEN- Tiguan [AD1]	5Q0819669		On Request
0 986 628 563	Cabin Filter, Activated Carbon+pro		SKODA- Superb [3U4]			On Request
0 986 628 565	Cabin Filter, Activated Carbon+pro		AUDI- e-tron [GEN], Q7 [4MB, 4MG], A8 [4N, D5], S5 [F5A, F5F] Sportback, e-tron [GEA] Sportback, A4 [8W2, 8WC, B9]; BENTLEY- Bentayga [4V1]			On Request
0 986 628 567	Cabin Filter, Activated Carbon+pro		MERCEDES-BENZ- EQC-Klasse [293], E-Klasse [213], C-Klasse [205], GLC-Klasse [253], GLC-Klasse [253] Coupe			On Request
0 986 628 571	Cabin Filter, Activated Carbon+pro		BMW- 5 [G 30], X 7 [G 07], 8 [G 16] Gran Coupe, 7 [G 12]	64115A1BDB7		On Request
0 986 628 572	Cabin Filter, Activated Carbon+pro		HYUNDAI- Elantra [MD, UD], Elite i20 [IB], i20 [IB] Active, i20 [BC3], i20 [GB]			On Request
0 986 628 575	Cabin Filter, Activated Carbon+pro		VOLVO- V90 II [235], XC60 II [246], XC90 II [256], S90 II [234]			On Request

### Filter Application Chart

Part Number	Product Description	Image	Model Description 	Potential OE Part No	Potential Comp. Part No	MRP (₹)
0 986 628 579	Cabin Filter, Activated Carbon+pro		BMW Mini- Mini [R 60] Countryman, Mini [R 56], Mini [R 57] Cabrio			On Request
0 986 628 580	Cabin Filter, Activated Carbon+pro		BMW- 3 [G 20]	64119382885		On Request
0 986 628 581	Cabin Filter, Activated Carbon+pro		LEXUS- ES [Z]			On Request
0 986 628 584	Cabin Filter, Activated Carbon+pro		HONDA- Jazz [2TF]			On Request
0 986 628 591	Cabin Filter, Activated Carbon+pro		PORSCHE- Cayenne [92A]			On Request
0 986 628 591	Cabin Filter, Activated Carbon+pro		VOLKSWAGEN- Touareg [7P5]	7P5819631		On Request
0 986 628 600	Cabin Filter, Activated Carbon+pro		MERCEDES-BENZ- C-Klasse [204], SLS-Klasse [197] Coupe, E-Klasse [207] Cabrio, E-Klasse [212], CLS-Klasse [218] SB, AMG GT [190] Roadster, CLS-Klasse [218] Coupe, E-Klasse [207] Coupe			On Request
0 986 628 608	Cabin Filter, Activated Carbon+pro		BMW- 3 [E 90], X 1 [E 84], 3 [E 93] Cabrio	64316803970		On Request
0 986 628 610	Cabin Filter, Activated Carbon+pro		CITROEN- C5 Aircross [C84]	9821501880		On Request









### Filter Application Chart

Part Number	Product Description	Image	Model Description 	Potential OE Part No	Potential Comp. Part No	MRP (₹)
0 986 628 622	Cabin Filter, Activated Carbon+pro		AUDI- S5 [8F7] Cabriolet, S4 [8K2, B8], Q5 [8RB], A5 [8F7] Cabriolet, RS5 [8T3] Coupe, A4 [8K2, B8]; PORSCHE- Macan [95B]			On Request
0 986 628 630	Cabin Filter, Activated Carbon+pro		AUDI- A3 [8VS, 8VM] Limousine, Q2 [GAB, GAG], TT [FV3, FVP] Coupe, A3 [8V1, 8VK], A3 [8V7, 8VE] Cabriolet; SKODA- Octavia [5E3], Kodiaq [NS], Superb [3V3]			On Request
0 986 628 630	Cabin Filter, Activated Carbon+pro		VOLKSWAGEN- Tiguan [AD1]	5Q0819669		On Request
9 450 030 116	Diesel Filter Kit (preliminary And Main Filter)		TATA MOTORS- 207 DI 3.0 Diesel (D) 48 Kw (2002.05 -2013.06)	254709110106, 252709110104		2,605.00
F 002 H24 990	Diesel Filter Kit (preliminary And Main Filter)		CHEVROLET- Beat 0.9D	J96896403		1,378.00
F 002 H26 625	Diesel Filter Kit (preliminary And Main Filter)		FORCE MOTORS- Gurkha 2.6D 4WD, Gurkha 2.4 Turbodiesel 4WD, Challenger 1.8 Diesel, Toofan Classic 2.6 Diesel, Gama 2.6 Diesel, Town & Country 2.4 Diesel, Trax 2.4D Tempo, Gama Classic 2.6 Diesel, Challenger 2.4 Diesel, Challenger 2.6 Diesel, Kargo King 2.6 Diesel, Judo 2.4 Diesel 4WD, Gama Classic 2.6 Diesel 4WD, Cruiser Classic 2.6 Diesel, Judo 2.4 Diesel; PREMIER- Padmini 1.4 Diesel; ICML- Rhino 2.0D 4x4			280.00





### Filter Application Chart

Part Number	Product Description	Image	Model Description 	Potential OE Part No	Potential Comp. Part No	MRP (₹)
F 002 H26 625	Diesel Filter Kit (preliminary And Main Filter)		MAHINDRA- Quanto 1.5D, XYLO 2.5 TD MDI, Bolero 2.5 BS III, Bolero Invader 2.5 Diesel, Bolero XL 2.5 Diesel, Commander 2.5 Diesel, Marshal 2.5 Diesel 4WD, Bolero 2.5 Diesel, Bolero 2.5 Diesel 4WD, Bolero 1.5 TD Power+, Bolero XLS 2.5 Diesel, Scorpio 2.5D, XUV500 2.2D, Bolero Invader GLX 2.5 Diesel, Scorpio 2.2 TD, Bolero Invader GLX 2.5 Diesel 4WD, Commander 2.1D Hard Top, Commander 2.1D 4WD Hard Top, XUV500 2.2D 4x4, Bolero 2.5 BS II, Marshal 2.1 Diesel, Scorpio 2.6 CRDe	0305DC0081N, 1001CA0800N, 1001CAA14881N, 100000A0370N, 7902000096, 0305DC0161N, 1001CAA10240N		280.00
F 002 H26 625	Diesel Filter Kit (preliminary And Main Filter)		MARUTI- Swift 1.3 Dzire TD, Swift 1.3 TD, Ritz 1.2 Generation I	15411M86J00		280.00
F 002 H26 625	Diesel Filter Kit (preliminary And Main Filter)		TATA MOTORS- Sumo Gold 3.0 d, Sumo 1.9 Diesel, 207 DI 3.0 Diesel (D) 48 Kw (2002.05 -2013.06), Sumo 3.0 Diesel BS2 Spacio, Sumo 1.9 Turbodiesel, Sumo 3.0 Diesel 8V, Sierra 1.9 Diesel, Safari 2.0 Turbodiesel, Sumo 1.9 Turbodiesel 4x4, Sumo 3.0D Spacio, Estate 1.9 Diesel, Sumo 3.0 Diesel, Safari 2.0 Turbodiesel 4x4, Sierra 1.9 Turbodiesel	252709110105, 253409110117, 254709110118, G9450030116, 254709110106, 253409110120		280.00
F 002 H26 625	Diesel Filter Kit (preliminary And Main Filter)		MAHINDRA- Scorpio 2.6 Diesel Turbo, Scorpio 2.6 Diesel Turbo 4x4	0305DC0081N, 1001CA0800N, 1001CAA14881N, 100000A0370N, 7902000096, 0305DC0161N, 1001CAA10240N		280.00
F 002 H21 221	Filter Kit (oil And Diesel Filter)		TATA MOTORS- Indica 1.4 Diesel			438.00
F 002 H22 012	Fuel Box Filter, Complete		MAHINDRA- XYLO 2.5 TD mEagle			1,268.00







### Filter Application Chart

Part Number	Product Description	Image	Model Description 	Potential OE Part No	Potential Comp. Part No	MRP (₹)
F 002 H27 407	Fuel Box Filter, Complete		FORCE MOTORS- Cruiser Classic 2.6 Diesel			93.00
0 450 902 161	Fuel Filter Element		HYUNDAI- Accent 1.6i 16V, Accent 1.5i 12V	319111A000	KNE -KL248	400.00
1 457 070 001	Fuel Filter Element		MARUTI- Dzire BS IV, Celerio 1.0 VXi Green CNG, Baleno 1.2, Swift 1.3 TD (D) 55 Kw (2011.08-->), Ignis 1.3 TD, Swift BS IV, Ertiga 1.3 TD Generation I, Swift 1.3 Dzire TD (D) 56 Kw (2012.02-->), Ciaz 1.3 TD	15411M55KD0, 15411M69P00		1,362.00
1 457 070 001	Fuel Filter Element		FIAT- Punto '03 [188], 500 [312]	77365902		1,362.00
1 457 070 007	Fuel Filter Element		SKODA- Laura			1,923.00
1 457 070 010	Fuel Filter Element		AUDI- Q7 [4LB]			3,890.00
1 457 070 010	Fuel Filter Element		VOLKSWAGEN- Touareg [7LA]	7L6127434C		3,890.00
1 457 070 014	Fuel Filter Element		AUDI- A3 [8V1, 8VK] (D) 105 Kw (2014.08 -2020.10); SKODA- Kodiaq [NS] (D) 140 Kw (2016.10-->), Kodiaq [NS] (D) 130 Kw (2018.07-->), Octavia [5E3] (D) 105 Kw (2013.10 -2020.10)			On Request

### Filter Application Chart









Part Number	Product Description	Image	Model Description 	Potential OE Part No	Potential Comp. Part No	MRP (₹)
1 457 070 014	Fuel Filter Element		VOLKSWAGEN- Tiguan [AD1] (D) 140 Kw (2017.05 -2020.07)	5Q0127177B, 5Q0127177, 5Q0127177D		On Request
9 451 037 405	Fuel Filter Element		TATA MOTORS- Sumo 3.0D Spacio (D) 48 Kw (2000.02 -2004.10)	252709110105		150.00
F 002 H20 152	Fuel Filter Element		MAHINDRA- Bolero 2.5 Diesel (D) 46 Kw (2011.11-->), Scorpio 2.2 mHawk140 CRDe 4WD (D) 103 Kw (2017.11-->), KUV100 1.2 TD (D) 57 Kw (2016.01-->), XUV500 2.2D (D) 103 Kw (2011.09 -2018.04), XUV500 2.2D 4x4 (D) 103 Kw (2011.09 -2018.04), TUV300 1.5 TD (D) 62 Kw (2015.09-->), Scorpio 2.2 mHawk140 CRDe 2WD (D) 103 Kw (2017.11-->), TUV 300 Plus 2.2 (D) 88 Kw (2018.05-->), Scorpio 2.5D (D) 55 Kw (2015.01-->), NuvoSport 1.5TD (D) 74 Kw (2016.04-->), TUV300 T10 1.5 mHawk100 (D) 74 Kw (2015.09-->), TUV300 1.5 TD Auto (D) 59 Kw (2015.09-->), Bolero 1.5 TD Power+ (D) 51 Kw (2016.09-->), Scorpio 2.2 TD (D) 88 Kw (2015.01-->), XUV500 2.2 W9 (D) 103 Kw (2017.12-->), Scorpio 2.2 TD 4WD (D) 88 Kw (2015.01-->), XUV300 1.5, Scorpio 2.2 TD (D) 87 Kw (2007.11 -2014.12)	1001CAA14881N, 0305DAB00581N		6,153.00
F 002 H21 299	Fuel Filter Element		TATA MOTORS- Indigo 1.4D eCS, Indica 1.4 Turbodiesel (D) 50 Kw (2005.10 -2010.01), Indigo 1.4i eCS (D) 51 Kw (2011.09 -2017.06), Indica 1.4 Diesel, Indica 1.4 Diesel 8V (D) 50 Kw (2008.05 -2010.01), Sumo 1.9 Turbodiesel 4x4 (D) 66 Kw (2001.01 -2004.01), Safari 2.2, Sumo 1.9D Grande, Sumo 2.2D Grande (D) 88 Kw (2008.02-->), Indica 1.4i (P) 44 Kw (1998.12 -2000.04), Indica Vista 1.4 Diesel 8V, Indigo 1.4D CS (D) 51 Kw (2008.03 -2011.09), Indigo 1.4D (D) 51 Kw (2007.02 -2009.10), Safari 4x2 Dicor (D) 85 Kw (2005.08 -2008.12)	279009110104, 571009119903, 254709110119, 279009110110, 279709110106, 278909110112, 886309000119, 253409110117, 279009110111		136.00

### Filter Application Chart



Part Number	Product Description	Image	Model Description 	Potential OE Part No	Potential Comp. Part No	MRP (₹)
F 002 H21 299	Fuel Filter Element		TATA MOTORS- Winger 1.9 Diesel (D) 66 Kw (2007.05 -2016.06)	279009110104, 571009119903, 254709110119, 279009110110, 279709110106, 278909110112, 886309000119, 253409110117, 279009110111		136.00
F 002 H23 416	Fuel Filter Element		TOYOTA- Innova 2.5 CRDi	233900L042, 233880L041, 233900L041, 233900L010		300.00
F 002 H23 441	Fuel Filter Element		HYUNDAI- Verna 1.5 CRDi, Sonata 2.0 CRDi	3192226910, 319700P500, 319222B900, 319700P400		1,678.00
F 002 H24 496	Fuel Filter Element		MAHINDRA- XYLO 2.2 TD mHawk (D) 91 Kw (2013.05-->), Bolero Invader 2.5 Diesel 4WD (D) 40 Kw (2003.03 -2004.10), Marazzo 1.5, Thar 2.5D 4x4 (D) 47 Kw (2010.12 -2013.04), Bolero XL 2.5 Diesel, Marshal 2.5 Diesel 4WD, Bolero 2.5 Diesel (D) 47 Kw (2007.03 -2011.09), XYLO, Maxx 2.5 Diesel Pik-Up (2005), Thar 2.5 TD, Bolero 2.5 Diesel (D) 46 Kw (2011.11-->)	9420000319, 10000A0370N, 0305DAB00581N		227.00
F 002 H24 518	Fuel Filter Element		TATA MOTORS- Indica Vista 1.4i, Indigo 1.2i eCS (P) 48 Kw (2011.09 -2018.08), Indigo 1.2i (P) 74 Kw (2007.02 -2011.01), Indigo 1.4i eCS (D) 51 Kw (2011.09 -2017.06), Indica 1.4i (P) 55 Kw (2000.05 -2010.01), Indigo Manza 1.4i (P) 66 Kw (2009.10 -2011.02), Indica Vista 1.2i 8V, Indigo 1.4i (P) 63 Kw (2006.09 -2009.10), Indigo 1.2i CS, Indica 1.2i 8V, Indica 1.2 CNG	278607999845, 279109110101, 279109110102, 570107999901, 288547704905	FLG -5010516	1,055.00
F 002 H24 990	Fuel Filter Element		SUZUKI- S-Cross 1.3 TD			1,378.00









### Filter Application Chart

Part Number	Product Description	Image	Model Description 	Potential OE Part No	Potential Comp. Part No	MRP (₹)
F 002 H24 990	Fuel Filter Element		MARUTI- S-cross 1.2	15411M55KD0		1,378.00
F 002 H24 990	Fuel Filter Element		CHEVROLET- Beat 0.9D	J96896403		1,378.00
F 002 H26 307	Fuel Filter Element		MAHINDRA- Scorpio 2.5D (D) 52 Kw (2007.10 -2014.10)	0305DC0161N		653.00
F 002 H26 307	Fuel Filter Element		MARUTI- Alto 0.8i 12V, Wagon R 1.0, Zen 1.1 Estilo, Wagon R 1.0i LPG, Alto 0.8i, Alto 1.0i, Alto 1.1i 16V, A-Star 1.0i 12V, Alto 800, Zen 1.0i Estilo CNG, Zen 1.0i Estilo	15410M79F01		653.00
F 002 H26 359	Fuel Filter Element		TATA MOTORS- Sumo 2.2D Grande (D) 88 Kw (2008.02-->), Indica 1.4 Turbodiesel (D) 50 Kw (2005.10 -2010.01), Indigo 1.2i (P) 74 Kw (2007.02 -2011.01), Indigo 1.4i (D) 51 Kw (2007.02 -2011.01), Indica 1.4i (P) 44 Kw (1998.12 -2000.04), Indigo 1.4 Turbodiesel, Safari 3.0D 4x4 Dicor (D) 85 Kw (2005.08 -2007.09), Safari 4x2 Dicor (D) 85 Kw (2005.08 -2008.12), Indigo Marina 1.4TD	279009110111, 253409110108, 253409110113		1,190.00
F 002 H26 537	Fuel Filter Element		MAHINDRA- BOLERO neo mHawk100, XUV 700 2.2, BOLERO BS6, THAR BS6 4x4, MARAZZO 1.5 BS6	S0305D020021N	MHL -KX653	590.00
F 002 H26 538	Fuel Filter Element		MAHINDRA- XUV 500 BS6, Scorpio	1001CAB0001KT	MHL -KX661	605.00











### Filter Application Chart

Part Number	Product Description	Image	Model Description 	Potential OE Part No	Potential Comp. Part No	MRP (₹)
F 002 H26 625	Fuel Filter Element		MAHINDRA- XYLO 2.2 TD mHawk (D) 91 Kw (2013.05-->), Quanto 1.5D, XYLO 2.5 TD MDI, KUV100 1.2 TD (D) 57 Kw (2016.01-->), XUV500 2.2D 4x4 (D) 103 Kw (2011.09 -2018.04), CL 500/550 2.5 Diesel, Scorpio 1.9TD 4x4, Bolero XLS 2.5 Diesel, TUV300 T10 1.5 mHawk100 (D) 74 Kw (2015.09-->), Bolero Invader 2.5 Diesel 4WD (D) 51 Kw (2004.12 -2006.10), Bolero 2.5 Diesel (D) 53 Kw (2000.08 -2005.04), XUV500 2.2 W9 (D) 103 Kw (2017.12-->), Scorpio 2.2 TD 4WD (D) 88 Kw (2015.01-->), Bolero 2.5 BS II, Scorpio 2.2 mHawk140 CRDe 4WD (D) 103 Kw (2017.11-->), Bolero 2.5 BS III, Thar 2.5D 4x4 (D) 77 Kw (2010.12 -2013.04), XUV500 2.2D (D) 103 Kw (2011.09 -2018.04), Bolero Invader 2.5 Diesel, TUV300 1.5 TD (D) 62 Kw (2015.09-->), Scorpio 2.2 mHawk140 CRDe 2WD (D) 103 Kw (2017.11-->), Bolero 2.5 Diesel 4WD, TUV 300 Plus 2.2 (D) 88 Kw (2018.05-->), Scorpio 2.5D (D) 55 Kw (2015.01-->), NuvoSport 1.5TD (D) 74 Kw (2016.04-->), KUV100 1.2, XUV300 1.2, Bolero 1.5 TD Power+ (D) 51 Kw (2016.09-->), Scorpio 2.2 TD (D) 88 Kw (2015.01-->), TUV300 1.5 TD Auto (D) 59 Kw (2015.09-->), XUV500 1.9TD, Scorpio 2.0, XYLO 2.5 TD mEagle, Scorpio 2.0i, Scorpio 2.2TD 4x4	0305DC0081N, 1001CA0800N, 1001CAA14881N, 100000A0370N, 7902000096, 0305DC0161N, 1001CAA10240N		280.00
F 002 H26 625	Fuel Filter Element		MARUTI- Swift 1.3 Dzire TD (D) 56 Kw (2008.03 -2012.02), Swift 1.3 TD (D) 56 Kw (2007.01 -2011.07)	15411M86J00		280.00

### Filter Application Chart

Part Number	Product Description	Image	Model Description 	Potential OE Part No	Potential Comp. Part No	MRP (₹)
F 002 H26 625	Fuel Filter Element		TATA MOTORS- Sumo Gold 3.0 d, Indigo 1.2i eCS (P) 48 Kw (2011.09 -2018.08), Indica 1.4 Turbodiesel (D) 50 Kw (2005.10 -2010.01), Indigo 1.2i (P) 74 Kw (2007.02 -2011.01), Sumo 1.9 Diesel, Indigo Marina 1.4i, Sumo 3.0 Diesel BS2 Spacio, Movus 2.2TD, Indica 1.4 Diesel 8V (D) 50 Kw (2008.05 -2010.01), Sumo 3.0 Diesel 8V, Sumo 1.9 Turbodiesel 4x4 (D) 66 Kw (2001.01 -2004.01), Sumo 1.9 Turbodiesel, Sumo 3.0D Spacio (D) 48 Kw (2000.02 -2004.10), Indigo 1.4D (D) 51 Kw (2005.06 -2009.10), Indigo 1.4D CS (D) 51 Kw (2008.05 -2009.10), Sierra 1.9 Diesel, Safari 2.0 Turbodiesel, Sumo 2.2D Grande (D) 88 Kw (2008.02-->), Indigo 1.4i (D) 51 Kw (2007.02 -2011.01), Indigo Marina 1.4 Diesel 16V, Safari 2.2 Diesel P5, Safari 3.0D 4x4 Dicor (D) 85 Kw (2005.08 -2007.09), Estate 1.9 Diesel, Sumo 3.0 Diesel, 207 DI 3.0 Diesel, Safari 2.0 Turbodiesel 4x4, Sierra 1.9 Turbodiesel	252709110105, 253409110117, 254709110118, G9450030116, 254709110106, 253409110120		280.00
F 002 H26 625	Fuel Filter Element		TATA MOTORS- Winger 1.9 Diesel (D) 66 Kw (2007.05 -2016.06)	252709110105, 253409110117, 254709110118, G9450030116, 254709110106, 253409110120		280.00
F 026 402 076	Fuel Filter Element		TATA MOTORS- ZEST 1.24 TD XTA, Indica Vista 1.3 TD, Indigo Manza 1.4i (P) 66 Kw (2009.10 -2011.02), Indigo Manza 1.2 TD	570309110105, 570309110110		4,027.00
F 026 402 217	Fuel Filter Element		SKODA- Superb [3T4]			On Request
F 026 402 248	Fuel Filter Element		AUDI- Q3 [8U] (D) 103 Kw (2013.08 -2015.04), Q3 [8U] (D) 130 Kw (2013.08 -2015.04)			On Request

### Filter Application Chart

Part Number	Product Description	Image	Model Description 	Potential OE Part No	Potential Comp. Part No	MRP (₹)
F 026 402 254	Fuel Filter Element		AUDI- A3 [8V1, 8VK] (D) 105 Kw (2014.08 -2020.10); SKODA- Kodiaq [NS] (D) 140 Kw (2016.10-->), Kodiaq [NS] (D) 130 Kw (2018.07-->), Octavia [5E3] (D) 105 Kw (2013.10 -2020.10)			On Request
F 026 402 254	Fuel Filter Element		VOLKSWAGEN- Tiguan [AD1] (D) 140 Kw (2017.05 -2020.07)	5Q0127177C		On Request
F 026 402 261	Fuel Filter Element		MERCEDES-BENZ- S-Klasse [223], GLC-Klasse [253], GLE-Klasse [167], G-Klasse [463]	6540920000		On Request
F 026 402 262	Fuel Filter Element		MERCEDES-BENZ- E-Klasse [213], C-Klasse [205], A-Klasse [177]	6540920100		On Request
F 026 402 353	Fuel Filter Element		CHEVROLET- Captiva [C140] (D) 135 Kw (2009.01-->)	42592178		On Request
F 026 402 360	Fuel Filter Element		CHEVROLET- Captiva [C140] (D) 135 Kw (2009.01-->)	95492920, 95174479		On Request
F 026 402 533	Fuel Filter Element		CITROEN- C5 Aircross [C84]	9801366680		On Request
F 026 402 809	Fuel Filter Element		AUDI- Q3 [8U] (D) 103 Kw (2013.08 -2015.04), Q3 [8U] (D) 130 Kw (2013.08 -2015.04)			On Request
F 026 402 809	Fuel Filter Element		VOLKSWAGEN- Passat [362]	7N0127177B		On Request







### Filter Application Chart

Part Number	Product Description	Image	Model Description 	Potential OE Part No	Potential Comp. Part No	MRP (₹)
1 457 434 106	Fuel Filter Spin-on		FIAT- Siena [178]	71736113		875.00
1 457 434 435	Fuel Filter Spin-on		MITSUBISHI- Lancer 2.0 Diesel	MB433425		1,175.00
1 457 434 443	Fuel Filter Spin-on		HYUNDAI- Accent [LC]	3192217400		1,102.00
1 457 434 511	Fuel Filter Spin-on		HYUNDAI- Creta 1.6 CRDi (D) 94 Kw (2015.10 -2021.06), Grand i10 1.1 CRDi, i20 [IB] Active, i20 [GB]	31922C8900		1,458.00
F 002 H21 249	Fuel Filter Spin-on		MARUTI- Swift 1.3 TD			887.00
F 002 H21 299	Fuel Filter Spin-on		MAHINDRA- Bolero 2.5 Diesel			136.00
F 002 H21 299	Fuel Filter Spin-on		TATA MOTORS- Indigo 1.4D eCS, Indica 1.4 Diesel, Indica Vista 1.4 Diesel 8V, Indigo 1.4D CS, Safari 2.2, Indigo 1.4D, Safari 4x2 Dicor	279009110104, 571009119903, 254709110119, 279009110110, 279709110106, 278909110112, 886309000119, 253409110117, 279009110111		136.00
F 002 H23 415	Fuel Filter Spin-on		CHEVROLET- Tavera 2.0D, Tavera 2.5D			551.00







### Filter Application Chart

Part Number	Product Description	Image	Model Description 	Potential OE Part No	Potential Comp. Part No	MRP (₹)
F 002 H23 441	Fuel Filter Spin-on		HYUNDAI- Verna 1.5 CRDi, Sonata 2.0 CRDi	3192226910, 319700P500, 319222B900, 319700P400		1,678.00
F 002 H24 518	Fuel Filter Spin-on		TATA MOTORS- Indica 1.4i	278607999845, 279109110101, 279109110102, 570107999901, 288547704905	FLG -5010516	1,055.00
F 002 H26 500	Fuel Filter Spin-on		HYUNDAI- Tucson 2.0 CRDi GLS AT 4WD, i20 1.4 TD, Tucson 2.0 Diesel 4WD (D) 82 Kw (2005.04 -2010.01), Creta 1.6 CRDi (D) 94 Kw (2015.10 -2021.06), Creta 1.4 TD, Grand i10 1.1 TD, Verna 1.6 TD, Verna 1.6i, Elantra 2.0 CRDi (D) 83 Kw (2004.04 -2008.12), Verna 1.6D, Elantra 1.6 TD, Verna 1.4D	319224H001		827.00
F 026 402 002	Fuel Filter Spin-on		LAND ROVER GROUP- Freelander [LN, L314]			On Request
F 026 402 110	Fuel Filter Spin-on		TOYOTA- Corolla [E15]	2339026160		On Request
F 026 402 362	Fuel Filter Spin-on		HYUNDAI- Santa Fe [DM]	319222W000, 31922A9000		On Request
F 026 402 813	Fuel Filter Spin-on		HYUNDAI- Tucson 2.0 Diesel 4WD (D) 82 Kw (2005.04 -2010.01), Elantra [MD, UD], i20 [PB, PBT], Elantra 2.0 CRDi (D) 83 Kw (2004.04 -2008.12)	319224H001		On Request
F 002 H20 152	Fuel Filter Spin-on, Fine Filter		MAHINDRA- Scorpio 2.5D, Scorpio 2.6 Diesel Turbo 4WD, Scorpio 2.6 Diesel Turbo, Scorpio 2.2 TD 4WD, Scorpio 2.2 TD, Scorpio 2.2 mHawk140 CRDe 2WD, Scorpio 2.2 mHawk140 CRDe 4WD, Scorpio 2.6 CRDe	1001CAA14881N, 0305DAB00581N		6,153.00

### Filter Application Chart







Part Number	Product Description	Image	Model Description 	Potential OE Part No	Potential Comp. Part No	MRP (₹)
F 002 H20 152	Fuel Filter Spin-on, Fine Filter		MAHINDRA- Scorpio 2.6 Diesel Turbo, Scorpio 2.6 Diesel Turbo 4x4	1001CAA14881N, 0305DAB00581N		6,153.00
F 002 H24 509	Fuel Filter Spin-on, Fine Filter		TATA MOTORS- Winger Van 1.9 D, Winger 1.9 Diesel	282947100184, 886309000119, 278809110104		274.00
F 002 H24 509	Fuel Filter Spin-on, Pre-filter		TATA MOTORS- Winger Van 1.9 D, Winger 1.9 Diesel	282947100184, 886309000119, 278809110104		274.00
1 457 434 314	Fuel Filter, Complete		ICML- Rhino 2.0D 4x4 (D) 74 Kw (2007.06 -2012.08); MARUTI- Ritz 1.2 Generation I (D) 55 Kw (2009.05 -2012.07), Swift 1.3 Dzire TD (D) 56 Kw (2008.03 -2012.02), Swift 1.3 TD (D) 56 Kw (2007.01 -2011.07); MAHINDRA- Scorpio 2.2 TD 4x4, Scorpio 2.6 CRDe (D) 85 Kw (2005.02 -2009.06), XUV500 2.2D (D) 103 Kw (2011.09 -2018.04), Quanto 1.5D (D) 74 Kw (2012.09 -2016.04), XUV500 2.2D 4x4 (D) 103 Kw (2011.09 -2018.04), Scorpio 2.5D (D) 52 Kw (2007.10 -2014.10), XYLO 2.5 TD MDI (D) 68 Kw (2009.01 -2012.02), Scorpio 2.2 TD (D) 87 Kw (2007.11 -2014.12)			1,385.00
1 457 434 314	Fuel Filter, Complete		MAHINDRA- Scorpio 2.6 Diesel Turbo (D) 85 Kw (2007.06 -2009.06), Scorpio 2.6 Diesel Turbo 4x4 (D) 85 Kw (2007.06 -2019.06)			1,385.00
9 450 030 116	Fuel Filter, Complete		MAHINDRA- Scorpio 2.6 Diesel Turbo 4WD (D) 80 Kw (2002.06 -2006.03), Bolero 2.5 Diesel (D) 53 Kw (2000.08 -2005.04), Bolero XLS 2.5 Diesel (D) 44.5 Kw (2004.02 -2005.12), Scorpio 2.6 Diesel Turbo (D) 80 Kw (2002.06 -2006.03); HINDUSTAN MOTORS LIMITED (HML)- Ambassador 2000 2.0 Diesel			2,605.00

### Filter Application Chart











Part Number	Product Description	Image	Model Description 	Potential OE Part No	Potential Comp. Part No	MRP (₹)
F 002 H20 113	Fuel Filter, Complete		TATA MOTORS- Safari 2.0 Turbodiesel 4x4 (D) 66 Kw (1998.02 -2007.09), Safari 2.0 Turbodiesel (D) 66 Kw (1998.02 -2008.12)			2,475.00
F 002 H21 229	Fuel Filter, Complete		MAHINDRA- Scorpio 2.6 Diesel Turbo 4WD (D) 80 Kw (2002.06 -2006.03), Scorpio 2.6 CRDe (D) 85 Kw (2005.02 -2009.06), Scorpio 2.6 Diesel Turbo (D) 80 Kw (2002.06 -2006.03)			1,547.00
F 002 H21 229	Fuel Filter, Complete		MAHINDRA- Scorpio 2.6 Diesel Turbo (D) 85 Kw (2007.06 -2009.06), Scorpio 2.6 Diesel Turbo 4x4 (D) 85 Kw (2007.06 -2019.06)			1,547.00
F 002 H21 249	Fuel Filter, Complete		MARUTI- Ritz 1.2 Generation I (D) 55 Kw (2009.05 -2012.07), Swift 1.3 TD (D) 55 Kw (2011.08-->)			887.00
F 002 H26 307	Fuel Filter, Complete		TATA MOTORS- Sumo Gold 3.0 d, Sumo 1.9 Diesel, Sumo 1.9 Turbodiesel 4x4, Sumo 3.0 Diesel BS2 Spacio, Safari 2.0 Turbodiesel 4x4 (D) 66 Kw (1998.02 -2007.09), Safari 2.0 Turbodiesel (D) 66 Kw (1998.02 -2008.12), Sumo 3.0D Spacio, Estate 1.9 Diesel, Sumo 1.9 Turbodiesel, Sumo 3.0 Diesel, 207 DI 3.0 Diesel, Sierra 1.9 Turbodiesel, Sierra 1.9 Diesel; ICML- Rhino 2.0D 4x4 (D) 54 Kw (2006.01 -2007.05), Rhino 2.0D 4x4 (D) 74 Kw (2007.06 -2012.08); FORCE MOTORS- Gurkha 2.6D 4WD, Gurkha 2.4 Turbodiesel 4WD, Challenger 1.8 Diesel, Toofan Classic 2.6 Diesel, Gama 2.6 Diesel, Town & Country 2.4 Diesel, Trax 2.4D Tempo, Challenger 2.6 Diesel, Gama Classic 2.6 Diesel, Challenger 2.4 Diesel, Kargo King 2.6 Diesel, Judo 2.4 Diesel 4WD, Gama Classic 2.6 Diesel 4WD, Judo 2.4 Diesel			653.00











### Filter Application Chart

Part Number	Product Description	Image	Model Description 	Potential OE Part No	Potential Comp. Part No	MRP (₹)
F 002 H26 307	Fuel Filter, Complete		MAHINDRA- Marshal 2.5 Diesel, XUV500 2.2D (D) 103 Kw (2011.09 -2018.04), Bolero Invader 2.5 Diesel, Commander 2.5 Diesel, XUV500 2.2D 4x4 (D) 103 Kw (2011.09 -2018.04), Scorpio 2.5D (D) 52 Kw (2007.10 -2014.10), XYLO 2.5 TD MDI (D) 68 Kw (2009.01 -2012.02), Marshal 2.5 Diesel 4WD, Bolero 2.5 Diesel 4WD, Bolero XLS 2.5 Diesel (D) 44.5 Kw (2004.02 -2005.12), Scorpio 2.6 CRDe (D) 85 Kw (2005.02 -2009.06), Bolero 2.5 Diesel (D) 53 Kw (2000.08 -2005.04), Quanto 1.5D (D) 74 Kw (2012.09 -2016.04), Bolero Invader GLX 2.5 Diesel, Bolero Invader GLX 2.5 Diesel 4WD, Commander 2.1D Hard Top, Commander 2.1D 4WD Hard Top, Marshal 2.1 Diesel, Bolero 2.5 BS II, Scorpio 2.2 TD (D) 87 Kw (2007.11 -2014.12)	0305DC0161N		653.00
F 002 H26 307	Fuel Filter, Complete		MARUTI- Ritz 1.2 Generation I (D) 55 Kw (2009.05 -2012.07), Swift 1.3 Dzire TD (D) 56 Kw (2008.03 -2012.02), Swift 1.3 TD (D) 56 Kw (2007.01 -2011.07), Swift 1.3 TD (D) 55 Kw (2011.08-->), A-Star 1.0i 12V, Swift 1.3 Dzire TD (D) 56 Kw (2012.02-->)	15410M79F01		653.00
F 002 H26 307	Fuel Filter, Complete		MAHINDRA- Scorpio 2.6 Diesel Turbo (D) 85 Kw (2007.06 -2009.06), Scorpio 2.6 Diesel Turbo 4x4 (D) 85 Kw (2007.06 -2019.06)	0305DC0161N		653.00
0 450 902 161	Fuel Filter, Gasoline Injection		MAHINDRA- Logan 1.4i		KNE -KL248	400.00
0 450 902 161	Fuel Filter, Gasoline Injection		HYUNDAI- Accent 1.6i 16V, Accent 1.5i 12V	319111A000	KNE -KL248	400.00









### Filter Application Chart

Part Number	Product Description	Image	Model Description 	Potential OE Part No	Potential Comp. Part No	MRP (₹)
0 450 902 161	Fuel Filter, Gasoline Injection		RENAULT- Duster 1.6, Logan 1.4i, Fluence [L3]	7700845961	KNE -KL248	400.00
0 450 905 030	Fuel Filter, Gasoline Injection		MERCEDES-BENZ- E-Klasse [210]	0024772801		2,245.00
0 450 905 264	Fuel Filter, Gasoline Injection		SKODA- Superb [3U4]			940.00
0 450 905 275	Fuel Filter, Gasoline Injection		MERCEDES-BENZ- G-Klasse [463]	0024772701		1,788.00
0 450 905 280	Fuel Filter, Gasoline Injection		OPEL- Corsa 1.6i Sail Hatchback, Corsa 1.4i, Corsa 1.6i, Astra F [T92], Corsa 1.4i Sail Hatchback	25161249		640.00
0 450 905 316	Fuel Filter, Gasoline Injection		DAEWOO- Matiz 0.8i	25121074		On Request
0 450 905 316	Fuel Filter, Gasoline Injection		OPEL- Vectra C [Z02]	25313359		On Request
0 450 905 318	Fuel Filter, Gasoline Injection		AUDI- A8 [4E, D3], TT [8N3] Coupe; BENTLEY- Continental Flying Spur [3W], Continental GT [393]; SKODA- Octavia [1U2]			On Request
0 450 905 318	Fuel Filter, Gasoline Injection		VOLKSWAGEN- New Beetle [1C1, 9C1] (P) 85 Kw (2001.06 -2010.09)	1J0201511A		On Request









### Filter Application Chart

Part Number	Product Description	Image	Model Description 	Potential OE Part No	Potential Comp. Part No	MRP (₹)
0 450 905 925	Fuel Filter, Gasoline Injection		VOLKSWAGEN- New Beetle [1C1, 9C1] (P) 85 Kw (2001.06 -2010.09)	6Q0201511		On Request
0 450 905 959	Fuel Filter, Gasoline Injection		SKODA- Fabia [5J2, 542] (P) 63 Kw (2010.03 -2014.12), Superb [3T4]; AUDI- TT [8J3] Coupe (P) 155 Kw (2010.05 -2014.06)			2,400.00
0 450 905 959	Fuel Filter, Gasoline Injection		VOLKSWAGEN- Beetle [5C1], Polo [6R1], Jetta [162]	1K0201051K		2,400.00
F 026 403 006	Fuel Filter, Gasoline Injection		SKODA- Rapid 1.6, Fabia [5J2, 542] (P) 63 Kw (2007.01 -2010.03), Fabia [5J2, 542] (P) 44 Kw (2006.12 -2009.05); AUDI- TT [8J3] Coupe (P) 184 Kw (2006.07 -2010.06)			2,065.00
F 026 403 006	Fuel Filter, Gasoline Injection		VOLKSWAGEN- New Beetle [1C1, 9C1] (P) 85 Kw (2001.06 -2010.09)	6Q0201051J		2,065.00
F 026 403 012	Fuel Filter, Gasoline Injection		AUDI- R8 [423], A6 [4F2, C6], R8 [429] Spyder			On Request
F 026 403 036	Fuel Filter, Gasoline Injection		FIAT- Palio [178] Weekend, Palio [178]	71736106, 7083750		On Request
F 026 403 756	Fuel Filter, Gasoline Injection		TOYOTA- Land Cruiser Prado [J12]	2330031100		On Request









### Filter Application Chart

Part Number	Product Description	Image	Model Description 	Potential OE Part No	Potential Comp. Part No	MRP (₹)
9 451 037 405	Fuel Fine Filter Element		MAHINDRA- CL 500/550 DI 2.5 Diesel 4WD, Marshal 2.5 Diesel, CL 500/550 MDI 2.5 Diesel, CL 500/550 MDI 2.5 Diesel 4WD, Major 2.5 Diesel 4WD, Major 2.5 Diesel, Commander 650 2.5 Diesel, Maxx 2.5 Diesel 4WD, CL 500/550 2.5 Diesel, Maxx 2.5 Diesel, Marshal 2.5 Diesel 4WD			150.00
9 451 037 405	Fuel Fine Filter Element		TATA MOTORS- Sumo 3.0D Spacio, 207 DI 3.0 Diesel	252709110105		150.00
F 002 H26 514	Fuel Fine Filter Element		MAHINDRA- Scorpio 2.2 TD 4WD, Bolero 1.5 TD Power+, TUV300 1.5 TD Auto, TUV300 1.5 TD, Scorpio 2.5D, XUV500 2.2D, TUV300 T10 1.5 mHawk100, NuvoSport 1.5TD, TUV 300 Plus 2.2, Scorpio 2.2 TD, KUV100 1.2 TD, XUV500 2.2 W9, XUV500 2.2D 4x4, Scorpio 2.2 mHawk140 CRDe 2WD, Scorpio 2.2 mHawk140 CRDe 4WD			630.00
0 450 904 058	Fuel Pipe Filter		BMW- 330 i			125.00
0 450 906 374	Fuel Pipe Filter		SKODA- Octavia [1U2], Octavia [1U5] Combi; AUDI- A4 [8EC, B7]			2,127.00
0 450 906 457	Fuel Pipe Filter		BMW- X 6 [F 16], 6 [F 06] Gran Coupe, 5 [E 60], 6 [F 12] Cabrio, X 5 [E 70], 5 [F 07] GT, X 5 [F 15], X 3 [E 83], X 6 [E 71], 5 [F 10], 7 [E 65], 7 [F 02], 6 [F 13] Coupe	13327822499		2,673.00
0 450 906 458	Fuel Pipe Filter		AUDI- A8 [4E, D3]			On Request









### Filter Application Chart

Part Number	Product Description	Image	Model Description 	Potential OE Part No	Potential Comp. Part No	MRP (₹)
0 450 906 500	Fuel Pipe Filter		SKODA- Rapid 1.6D, Fabia [5J2, 542]			1,410.00
0 450 906 500	Fuel Pipe Filter		VOLKSWAGEN- Polo 1.5 TD, Vento 1.5 TDI HIGHLINE, Polo 1.2D, POLO BS-VI, Polo [6R1], Polo 1.5 TDi, Vento 1.5 TD, Vento 1.6 D, CrossPolo 1.5 TDi, Ameo BS-VI, Vento 1.5 TDi	6Q0127401F		1,410.00
0 450 907 013	Fuel Pipe Filter		NISSAN- Micra [K13K]			On Request
0 986 450 509	Fuel Pipe Filter		SKODA- Superb 2.5 TDI			2,402.00
1 457 434 437	Fuel Pipe Filter		MERCEDES-BENZ- S-Klasse [221] (D) 173 Kw (2005.12 -2009.04), R-Klasse [251] (D) 140 Kw (2009.05 -2010.05), E-Klasse [211], CLS-Klasse [219], S-Klasse [221] (D) 173 Kw (2009.05 -2013.12), GL-Klasse [164] (D) 165 Kw (2009.05 -2010.08), M-Klasse [164] (D) 140 Kw (2009.05 -2010.12)	6460920501		1,401.00
F 002 H23 416	Fuel Pipe Filter		TOYOTA- Innova 2.5 CRDi, Fortuner 2.5 D-4D	233900L042, 233880L041, 233900L041, 233900L010		300.00
F 002 H23 421	Fuel Pipe Filter		MARUTI- Dzire 1.2, Swift 1.2, Swift 1.2i, Swift 1.2i Dzire, Swift 1.3i, Swift 1.3i Dzire, Ritz 1.2 Generation I	15410M74L00		242.00
F 002 H23 423	Fuel Pipe Filter		MARUTI- Wagon R 1.0, Alto 0.8i 12V, Zen 1.1 Estilo, Alto 800 CNG, Alto 0.8i, Alto 1.1i 16V, Wagon R 1.1i 16V, Alto 1.0i, 800 0.8i 12V, Alto 800	15410M79F01		237.00









### Filter Application Chart

Part Number	Product Description	Image	Model Description 	Potential OE Part No	Potential Comp. Part No	MRP (₹)
F 002 R20 002	Fuel Pipe Filter		TATA MOTORS- Indica 1.4i, Indica 1.2 CNG	279109110102		566.00
F 026 402 076	Fuel Pipe Filter		TATA MOTORS- Indigo Manza 1.2 TD	570309110105, 570309110110		4,027.00
F 026 402 076	Fuel Pipe Filter		FIAT- Punto Evo [199], Linea 1.2 TD	77363657		4,027.00
F 026 402 085	Fuel Pipe Filter		BMW- 3 [E 93] Cabrio (D) 180 Kw (2009.03 -2013.09), 3 [E 90] (D) 130 Kw (2007.09 -2010.03)	13327793672		On Request
F 026 402 095	Fuel Pipe Filter		LAND ROVER GROUP- Freelander [LN, L314]			On Request
F 026 402 103	Fuel Pipe Filter		MERCEDES-BENZ- C-Klasse [204] (D) 150 Kw (2008.09 -2014.12), S-Klasse [221] (D) 173 Kw (2005.12 -2009.04), E-Klasse [212] (D) 150 Kw (2008.12 -2016.08), E-Klasse [212] (D) 170 Kw (2008.08 -2010.11), R-Klasse [251] (D) 140 Kw (2009.05 -2010.05), E-Klasse [212] (D) 120 Kw (2008.12 -2014.12), C-Klasse [204] (D) 125 Kw (2012.10 -2014.12), S-Klasse [221] (D) 173 Kw (2009.05 -2013.12), GL-Klasse [164] (D) 165 Kw (2009.05 -2010.08), M-Klasse [164] (D) 140 Kw (2009.05 -2010.12)	6420920301		2,095.00
F 026 402 106	Fuel Pipe Filter		BMW- X 1 [E 84], 3 [E 93] Cabrio (D) 180 Kw (2009.03 -2013.09), 3 [E 90] (D) 130 Kw (2007.09 -2010.03), X 3 [F 25]	13328584874		2,997.00

### Filter Application Chart









Part Number	Product Description	Image	Model Description 	Potential OE Part No	Potential Comp. Part No	MRP (₹)
F 026 402 257	Fuel Pipe Filter		BMW Mini- Mini [F 56]			On Request
F 026 402 257	Fuel Pipe Filter		BMW- 2 [F 44] Gran Coupe, X 1 [F 48]	13328584868		On Request
F 026 402 358	Fuel Pipe Filter		BMW- 3 [G 20], 5 [G 30], X 7 [G 07], 7 [G 12]	13328591019		On Request
F 026 402 808	Fuel Pipe Filter		AUDI- A7 [4G, C7] Sportback, A4 [8W2, 8WC, B9]			2,137.00
F 026 402 824	Fuel Pipe Filter		BMW Mini- Mini [R 60] Countryman			On Request
F 026 402 824	Fuel Pipe Filter		BMW- 3 [F 34] GT, 1 [F 20], 3 [F 30]	13327822497, 13328572522		On Request
F 026 402 836	Fuel Pipe Filter		MERCEDES-BENZ- E-Klasse [212] (D) 170 Kw (2008.08 -2010.11), E-Klasse [213], GLS-Klasse [166], GLA-Klasse [156], B-Klasse [246], E-Klasse [212] (D) 195 Kw (2010.12 -2013.12), S-Klasse [222], GLE-Klasse [166] (D) 190 Kw (2015.04 -2018.10), R-Klasse [251] (D) 195 Kw (2010.05 -2012.10), GL-Klasse [166], M-Klasse [166] (D) 190 Kw (2011.06 -2015.08)	6420906052		On Request

### Filter Application Chart







Part Number	Product Description	Image	Model Description 	Potential OE Part No	Potential Comp. Part No	MRP (₹)
F 026 402 839	Fuel Pipe Filter		MERCEDES-BENZ- C-Klasse [204] (D) 150 Kw (2008.09 -2014.12), M-Klasse [166] (D) 150 Kw (2011.06 -2015.08), E-Klasse [212] (D) 150 Kw (2008.12 -2016.08), C-Klasse [205], E-Klasse [212] (D) 120 Kw (2008.12 -2014.12), GLC-Klasse [253], CLS-Klasse [218] SB, C-Klasse [204] (D) 125 Kw (2012.10 -2014.12), GLE-Klasse [166] (D) 150 Kw (2015.04 -2018.10), GLC-Klasse [253] Coupe	6510902852		On Request
F 026 402 846	Fuel Pipe Filter		JAGUAR- XF [X250]	AJ811141	JAG -AJ811141	On Request
F 026 402 846	Fuel Pipe Filter		LAND ROVER GROUP- Evoque [LV,L538], Freelander [L359], Discovery Sport [LC,L550]	LR001313	JAG -AJ811141	On Request
9 451 037 404	Fuel Pre-filter Element		TATA MOTORS- Sumo 3.0D Spacio, 207 DI 3.0 Diesel			124.00
9 451 037 404	Fuel Pre-filter Element		MAHINDRA- CL 500/550 DI 2.5 Diesel 4WD, Marshal 2.5 Diesel, CL 500/550 MDI 2.5 Diesel, CL 500/550 MDI 2.5 Diesel 4WD, Major 2.5 Diesel 4WD, Major 2.5 Diesel, Commander 650 2.5 Diesel, Maxx 2.5 Diesel 4WD, Marshal 2.5 Diesel 4WD, CL 500/550 2.5 Diesel, Maxx 2.5 Diesel	9420000388		124.00
1 457 434 293	Fuel Pre-filter, Complete		FIAT- Petra 1.9 Ds			1,401.00
0 986 452 044	Oil Filter Element		TOYOTA- Innova 2.0i, Innova 2.0	90915TB001, 90915YZZJ4, 9091520003, 90915YZZJ3		494.00







### Filter Application Chart

Part Number	Product Description	Image	Model Description 	Potential OE Part No	Potential Comp. Part No	MRP (₹)
1 457 429 119	Oil Filter Element		LAND ROVER GROUP- Freelander [LN, L314]			On Request
1 457 429 122	Oil Filter Element		MERCEDES-BENZ- 124-Serie [124], E-Klasse [210] (P) 110 Kw (1995.06 -1997.08), E-Klasse [210] (P) 100 Kw (1998.01 -2000.02), C-Klasse [203] (P) 95 Kw (2000.10 -2002.08)	1041800709		577.00
1 457 429 144	Oil Filter Element		PORSCHE- Boxster [987] (P) 217 Kw (2006.09 -2008.08), Cayman [987C] (P) 217 Kw (2005.11 -2009.01), 911 [997] (P) 235 Kw (2004.07 -2008.05), Cayenne [9PA] (P) 250 Kw (2002.09 -2007.01)	99610722560, 99610722553		On Request
1 457 429 152	Oil Filter Element		SKODA- Superb 2.5 TDI			1,007.00
1 457 429 192	Oil Filter Element		SKODA- Fabia [5J2, 542] (D) 51 Kw (2007.02 -2010.03), Laura, Superb [3T4] (P) 191 Kw (2008.11 -2015.05), Superb [3T4] (D) 103 Kw (2009.01 -2010.03); AUDI- A6 [4F2, C6] (D) 125 Kw (2008.10 -2011.08), A4 [8K2, B8] (D) 105 Kw (2007.11 -2012.03), TT [8J3] Coupe			644.00
1 457 429 192	Oil Filter Element		VOLKSWAGEN- Passat [3C2]	071115562C		644.00
1 457 429 194	Oil Filter Element		SKODA- Fabia [5J2, 542] (P) 44 Kw (2006.12 -2009.05)			450.00
1 457 429 194	Oil Filter Element		VOLKSWAGEN- Polo MPI, Ameo BS6 Corporate Edition	03D115403D, 03D198819C		450.00







### Filter Application Chart

Part Number	Product Description	Image	Model Description 	Potential OE Part No	Potential Comp. Part No	MRP (₹)
1 457 429 252	Oil Filter Element		BMW- 5 [E 60], X 5 [E 70] (D) 173 Kw (2008.10 -2010.03), 7 [E 65]	11427788460		On Request
1 457 429 256	Oil Filter Element		FIAT- 500 [312] (D) 55 Kw (2007.07 -2012.12), Punto '03 [188] (D) 52 Kw (2009.06 -2010.12), Linea [323]	6000633302		780.00
1 457 429 257	Oil Filter Element		FORD- Mondeo '01 [B4Y]		MOT -EFL404	On Request
1 457 429 261	Oil Filter Element		MERCEDES-BENZ- C-Klasse [203] (P) 120 Kw (2002.05 -2007.02), SLK-Klasse [171] (P) 135 Kw (2007.12 -2010.11), SLK-Klasse [171] (P+GAS) 120 Kw (2004.04 -2007.11)	2711800109		677.00
1 457 429 262	Oil Filter Element		BMW- 3 [E 90] (P) 110 Kw (2005.03 -2011.12), X 1 [E 84] (P) 100 Kw (2010.03 -2015.06)	11427508969		On Request
1 457 429 263	Oil Filter Element		MERCEDES-BENZ- S-Klasse [221] (P) 170 Kw (2005.09 -2009.12), SLK-Klasse [171] (P) 200 Kw (2004.04 -2008.12), G-Klasse [463] (P) 350 Kw (2004.04 -2011.08), E-Klasse [211] (P) 130 Kw (2002.03 -2006.06), E-Klasse [207] Cabrio, M-Klasse [164], CL-Klasse [216] (P) 285 Kw (2006.06 -2010.07), CLS-Klasse [219], CLK-Klasse [209] Cabrio, E-Klasse [210] (P) 125 Kw (1997.09 -2000.04), S-Klasse [220], C-Klasse [203] (P) 270 Kw (2004.02 -2007.08), E-Klasse [211] (P) 170 Kw (2006.01 -2009.03), S-Klasse [221] (P) 200 Kw (2009.01 -2012.12), R-Klasse [251], E-Klasse [211] (P) 150 Kw (2007.09 -2009.03), SL-Klasse [230], E-Klasse [207] Coupe	0001802609		520.00







### Filter Application Chart

Part Number	Product Description	Image	Model Description 	Potential OE Part No	Potential Comp. Part No	MRP (₹)
1 457 429 274	Oil Filter Element		MERCEDES-BENZ- E-Klasse [124]	6011800109		660.00
1 457 429 308	Oil Filter Element		HYUNDAI- Accent 1.5 DLS, Elantra 2.0 CRDi	2632027110		1,076.00
1 457 429 619	Oil Filter Element		SKODA- Octavia [1U2], Octavia [1U5] Combi; AUDI- A4 [8EC, B7]			538.00
1 457 437 001	Oil Filter Element		MERCEDES-BENZ- E-Klasse [211] (D) 110 Kw (2002.03 -2006.03), C-Klasse [203] (D) 100 Kw (2004.01 -2007.12), C-Klasse [203] (D) 75 Kw (2000.07 -2003.06), C 220 CDI (D) 125 Kw (2010.11 -2011.12), E-Klasse [210] (D) 100 Kw (1999.08 -2002.03), E-Klasse [211] (D) 120 Kw (2002.03 -2005.03)	6111800009, A6111800009		491.00
3 397 005 295	Oil Filter Element		TATA MOTORS- Aria 2.2D	284582409902, G269982409908, 278918130101, 284582400103		437.00
9 451 037 456	Oil Filter Element		TATA MOTORS- Sumo Gold 3.0 d, Sumo 3.0D Spacio, Sumo 3.0 Diesel 8V, Sumo 3.0 Diesel BS2 Spacio (D) 48 Kw (2000.02-->)	252718130105, 253418130169	FLG -LF16059	345.00
9 951 030 134	Oil Filter Element		TATA MOTORS- Sumo 1.9 Diesel	254718130117		301.00
F 002 H20 215	Oil Filter Element		MAHINDRA- MM 440 2.2			139.00







### Filter Application Chart

Part Number	Product Description	Image	Model Description 	Potential OE Part No	Potential Comp. Part No	MRP (₹)
F 002 H20 264	Oil Filter Element		TATA MOTORS- Indica 1.4i (P) 44 Kw (1998.12 -2000.04), Indigo 1.2i (P) 74 Kw (2007.02 -2011.01), Indica 1.4 Diesel (D) 39 Kw (1998.12 -2012.06)	279018130104, 279018130101, 279018130102, G279018130103, 279018130105		220.00
F 002 H20 377	Oil Filter Element		MARUTI- Baleno 1.2 (P) 62 Kw (2015.10-->), Baleno 1.6i (P) 69 Kw (1999.11 -2005.10), Ertiga 1.5 Smart Hybrid Generation II, Dzire BS IV, Baleno Altura 1.6i, Swift 1.3i, Alto 800 CNG, 800 0.8 i 6V, Ignis 1.2, Alto 1.1i 16V, Swift BS IV, Celerio X 1.0 2WD	16510M82713, 16510M68K10, 16510M68K00, 16510M73080, 16510M82703		190.00
F 002 H23 432	Oil Filter Element		SUZUKI- S-Cross 1.3 TD			268.00
F 002 H23 432	Oil Filter Element		MARUTI- Dzire 1.2, Swift 1.3 Dzire TD, Ritz 1.2 Generation I (D) 55 Kw (2009.05 -2012.07), S-cross 1.2, SX4 1.3D, Vitara Brezza 1.2, Swift 1.3 TD, Baleno 1.2 (D) 55 Kw (2015.10-->), Celerio 1.0 VXi Green CNG (P+GAS) 43 Kw (2014.05-->), Ertiga 1.3 TD Generation I, Ciaz 1.3 TD	16500M86J20, 16510M86J20		268.00
F 002 H23 432	Oil Filter Element		TATA MOTORS- Indica 1.4i (P) 44 Kw (1998.12 -2000.04), Indigo 1.2i (P) 74 Kw (2007.02 -2011.01), Indica Vista 1.4 Diesel 8V, Indica Vista 1.2D, Indica 1.4 Diesel (D) 39 Kw (1998.12 -2012.06)	59063972, 279018130106, 570318109924		268.00
F 002 H23 434	Oil Filter Element		TATA MOTORS- Indigo 1.4D eCS, Indigo 1.2i (P) 74 Kw (2007.02 -2011.01), Indica Vista 1.2i 8V, Indigo 1.4D CS, Indica 1.2i 8V, Indigo 1.4i eCS, Indigo 1.2i CS, ZEST 1.24 TD XTA, Indigo Manza 1.4i, Indica 1.4 Diesel 8V, Indica Vista 1.3 TD, Indigo Marina 1.4 Diesel 16V, Indigo 1.4i, Indica 1.4 Turbodiesel, Indigo Manza 1.2 TD, Indigo 1.2i eCS, ZEST 1.2 TD, Indigo 1.4D, Bolt 1.2 TD, Indica 1.2 CNG	279018130104, 59063972, 279018130101, 279018130102, 279018130106, 570318139905, 570318139923, 279818130101, 55197218, 279018130105		358.00











### Filter Application Chart

Part Number	Product Description	Image	Model Description 	Potential OE Part No	Potential Comp. Part No	MRP (₹)
F 002 H23 435	Oil Filter Element		HYUNDAI- Verna 1.5 CRDi			604.00
F 002 H23 439	Oil Filter Element		MAHINDRA- Scorpio 2.0i, Quanto 1.5D, XYLO 2.5 TD MDI, Bolero Invader 2.5 Diesel 4WD, Scorpio 2.2 TD 4WD, Bolero 1.5 TD Power+, Maxx 2.5 Diesel Pik-Up (2005), TUV300 1.5 TD, Scorpio 1.9TD 4x4, Bolero XLS 2.5 Diesel, XUV500 2.2D, TUV300 T10 1.5 mHawk100, Bolero Invader GLX 2.5 Diesel, KUV100 1.2 TD, Maxx 2.5 Diesel, Scorpio 2.2 mHawk140 CRDe 2WD, Bolero 2.5 BS II, XUV500 2.2D 4x4, Marshal 2.5 Diesel, Bolero 2.5 BS III, Bolero Invader 2.5 Diesel, Bolero XL 2.5 Diesel, Thar 2.5D 4x4, Bolero 2.5 Diesel, Bolero 2.5 Diesel 4WD, TUV300 1.5 TD Auto, Scorpio 2.5D, XYLO 2.2 TD mHawk, KUV100 1.2, Marazzo 1.5, XUV500 1.9TD, Scorpio 2.0, Scorpio 2.2 TD, Bolero Invader GLX 2.5 Diesel 4WD, Commander 655 2.5 Diesel 4WD, XUV500 2.2 W9, XYLO 2.5 TD mEagle, XUV300 1.5, Scorpio 2.2TD 4x4	9420000073, 9420000074, 0303BAM00350N, 0303BC0071N, 0303BC0010N, 71817, 24772, 0303BC0073N, 0303BAU00110N		219.00
F 002 H23 467	Oil Filter Element		HONDA- Civic 1.8i, Accord 2.3i 16V, Accord 3.0i, BR-V 1.5 i-VTEC, City 1.5i 16V VTEC, City 1.5 i 8V, City 1.5i ZX VTEC, City 1.5, Accord 2.4i 16V, City 1.5i 16V	15400PH1F03, 15400PR3014, 15400RAFT01, 15400RZ0G01, 15400RTA004, 15400PLC004, 154005Z8E01, 15400RTA003, 15400PMET01, 16010ST5933, 15400P3RE01		295.00
F 002 H23 487	Oil Filter Element		FORD- Fiesta 1.4 Turbodiesel, Figo 1.4D, Fusion 1.4 Diesel 8V, Fiesta 1.5 Turbodiesel, Freestyle Hatchback, Figo Aspire 1.5 TDCi, EcoSport 1.5 TD			559.00
F 002 H23 523	Oil Filter Element		MARUTI- Wagon R 1.0, Wagon R 1.0i LPG, Alto 1.0i, Alto 1.0 CNG/LPG, Zen 1.0i Estilo CNG, Zen 1.0i Estilo	16510M65L10		162.00









### Filter Application Chart

Part Number	Product Description	Image	Model Description 	Potential OE Part No	Potential Comp. Part No	MRP (₹)
F 002 H23 550	Oil Filter Element		MARUTI- Ritz 1.2 Generation I (P) 63 Kw (2009.05 -2012.07), Celerio 1.0, Alto 0.8i, A-Star 1.0i 12V, Alto 800, Alto 0.8i 12V, Ertiga 1.4 CNG Generation I, Swift 1.2i, Swift 1.2i Dzire, Baleno 1.6i (P) 67 Kw (2005.10 -2007.04), Swift 1.3i Dzire, Eeco 1.2i, Celerio 1.0 VXi Green CNG (P+GAS) 43 Kw (2014.05-->), Ciaz 1.4 Generation I, Ertiga 1.4 Generation I	16510M68K10, 16510M68K00, 16510M82703		167.00
F 002 H23 551	Oil Filter Element		MAHINDRA- Logan 1.4i, Logan 1.5 Diesel	7700274177, 8200768927, 8671002274, 8200768913		270.00
F 002 H24 311	Oil Filter Element		MARUTI- Omni 0.8 Generation I, Zen 1.1 Estilo, Gypsy 1.3 4WD, Omni 0.8 LPG Generation II, Esteem 1.3i, 1000 1.0i 8V, Zen 1.0i, Gypsy 1.0 4WD, Omni 0.8 Generation II, Gypsy 1.3i 4WD, 800 0.8i 6V, 800 LPG	16510M73080, 16510M73013, 16510M82703, 16510M73010		148.00
F 002 H24 495	Oil Filter Element		TATA MOTORS- Nano 0.6i, Nano 0.6i CNG, Nano 0.6	570518130102		193.00
F 002 H24 987	Oil Filter Element		HONDA- Mobilio 1.5 TD, Amaze First Gen 1.5	15400RZ0G01, 154005Z8E01		347.00
F 002 H24 988	Oil Filter Element		TOYOTA- Etios 1.4D Liva, Etios 1.4D, Etios Cross 1.4TD	415231110		165.00
F 002 H26 501	Oil Filter Element		RENAULT- Kwid 0.8, Kwid 1.0	152088127R		190.00

### Filter Application Chart







Part Number	Product Description	Image	Model Description 	Potential OE Part No	Potential Comp. Part No	MRP (₹)
F 002 H60 003	Oil Filter Element		TATA MOTORS- Sumo 3.0 Diesel BS2 Spacio (D) 48 Kw (2000.02-->)			239.00
F 026 407 002	Oil Filter Element		AUDI- A8 [4E, D3] (D) 171 Kw (2004.01 -2010.07), Q7 [4LB] (D) 171 Kw (2006.08 -2008.05), A6 [4F2, C6] (D) 165 Kw (2004.04 -2006.05), A6 [4FH, C6] Allroad (D) 132 Kw (2006.05 -2008.10)			935.00
F 026 407 002	Oil Filter Element		VOLKSWAGEN- Touareg [7LA]	057115561L		935.00
F 026 407 006	Oil Filter Element		CHEVROLET- Cruze [J300]	55594651		On Request
F 026 407 011	Oil Filter Element		AUDI- R8 [423], Q7 [4LB] (P) 257 Kw (2006.03 -2010.05), R8 [4S3, 4SP], A8 [4H, D4] (P) 273 Kw (2009.11 -2014.04), RS5 [8T3] Coupe, R8 [429] Spyder			On Request
F 026 407 014	Oil Filter Element		NISSAN- X-Trail [T31]	1520900Q0A		On Request
F 026 407 014	Oil Filter Element		RENAULT- Koleos [HY]	8200362442		On Request
F 026 407 023	Oil Filter Element		AUDI- A4 [8K2, B8] (D) 130 Kw (2013.09 -2015.12), Q3 [8U]; SKODA- Superb [3T4] (D) 103 Kw (2010.02 -2015.05), Yeti [5L7]			597.00
F 026 407 023	Oil Filter Element		VOLKSWAGEN- Passat [362], Polo [6R1] (D) 77 Kw (2013.09 -2014.06), Vento 1.5 TDI HIGHLINE, POLO BS-VI, Jetta [162], Ameo BS-VI	03L115389H, 03L115562		597.00

### Filter Application Chart







Part Number	Product Description	Image	Model Description 	Potential OE Part No	Potential Comp. Part No	MRP (₹)
F 026 407 066	Oil Filter Element		AUDI- A8 [4H, D4] (D) 258 Kw (2009.11 -2014.04), A8 [4E, D3] (D) 171 Kw (2004.01 -2010.07), A6 [4F2, C6] (D) 176 Kw (2008.10 -2011.08), Q7 [4LB] (D) 250 Kw (2009.06 -2010.05), Q7 [4LB] (D) 171 Kw (2006.08 -2008.05), A6 [4FH, C6] Allroad (D) 132 Kw (2006.05 -2008.10)			710.00
F 026 407 066	Oil Filter Element		PORSCHE- Cayenne [92A] (D) 281 Kw (2012.09 -2014.08), Cayenne [92A] (D) 176 Kw (2010.09 -2011.08)	95510722200		710.00
F 026 407 067	Oil Filter Element		FIAT- 500 [312] (D) 55 Kw (2007.07 -2012.12), Punto '03 [188] (D) 52 Kw (2009.06 -2010.12)	73504027		On Request
F 026 407 072	Oil Filter Element		BMW- X 3 [E 83], 3 [E 90] (D) 130 Kw (2007.09 -2010.03), X 1 [E 84] (D) 120 Kw (2009.10 -2012.06)	11427807177		1,246.00
F 026 407 090	Oil Filter Element		LEXUS- RX			On Request
F 026 407 094	Oil Filter Element		BMW- X 5 [E 70] (D) 155 Kw (2010.04 -2013.06), 7 [F 02] (D) 180 Kw (2009.03 -2012.06), 5 [F 10] (D) 150 Kw (2010.03 -2011.08), X 6 [E 71] (D) 155 Kw (2010.04 -2014.06), 5 [F 07] GT, 5 [F 10] (D) 180 Kw (2010.03 -2011.08), X 6 [E 71] (D) 225 Kw (2010.04 -2014.06), 3 [E 93] Cabrio (D) 180 Kw (2009.03 -2013.09)	11427808443		1,170.00
F 026 407 096	Oil Filter Element		FIAT- Punto Evo [199]	71770689		On Request









### Filter Application Chart

Part Number	Product Description	Image	Model Description 	Potential OE Part No	Potential Comp. Part No	MRP (₹)
F 026 407 102	Oil Filter Element		PORSCHE- Cayenne [92A] (P) 294 Kw (2010.09 -2014.08), Panamera [970] (P) 368 Kw (2009.03 -2013.09), Panamera [970] (P) 309 Kw (2013.07 -2016.08), Cayenne [9PA] (P) 283 Kw (2007.02 -2010.09), Cayenne [92A] (P) 419 Kw (2014.09 -2018.05), Panamera [970] (P) 294 Kw (2009.03 -2013.09), 911 [991], Panamera [970] (P) 220 Kw (2010.05 -2013.09), Cayenne [9PA] (P) 368 Kw (2007.02 -2010.08), 911 [991] Cabriolet, 911 [997] (P) 254 Kw (2008.06 -2012.09)	94810722200		On Request
F 026 407 112	Oil Filter Element		MERCEDES-BENZ- C-Klasse [204] (D) 150 Kw (2008.09 -2014.12), GLA-Klasse [156], CLA-Klasse [117], C-Klasse [204] (D) 125 Kw (2012.10 -2014.12), B-Klasse [246], GLC-Klasse [253] (D) 120 Kw (2015.07 -2019.03), GLC-Klasse [253] Coupe, M-Klasse [166], E-Klasse [212], C 220 CDI (D) 125 Kw (2015.02-->), CLS-Klasse [218] SB, C-Klasse [205] (D) 150 Kw (2016.03-->), A-Klasse [176], GLE-Klasse [166]	6511800109		860.00
F 026 407 122	Oil Filter Element		AUDI- Q5 [8RB], A7 [4G, C7] Sportback, A8 [4H, D4] (D) 184 Kw (2011.01 -2016.02)			On Request
F 026 407 122	Oil Filter Element		VOLKSWAGEN- Touareg [7P5]	059198405		On Request
F 026 407 122	Oil Filter Element		PORSCHE- Panamera [970] (D) 185 Kw (2011.08 -2016.08), Macan [95B] (D) 190 Kw (2014.03 -2018.08)	95810722220		On Request
F 026 407 123	Oil Filter Element		BMW Mini- Mini [R 60] Countryman			1,205.00









### Filter Application Chart

Part Number	Product Description	Image	Model Description 	Potential OE Part No	Potential Comp. Part No	MRP (₹)
F 026 407 123	Oil Filter Element		BMW- 6 [F 13] Coupe (D) 230 Kw (2012.03 -2017.10), 6 [F 12] Cabrio (D) 230 Kw (2012.03 -2018.05), 7 [F 02] (D) 180 Kw (2012.07 -2015.05), X 3 [F 25] (D) 120 Kw (2010.10 -2017.08), 3 [F 34] GT, 1 [F 20] (D) 105 Kw (2013.09 -2015.02), 5 [F 10] (D) 100 Kw (2010.05 -2016.10), 5 [F 10] (D) 190 Kw (2011.09 -2016.10), 6 [F 06] Gran Coupe (D) 230 Kw (2012.05 -2018.10), 5 [F 10] (D) 160 Kw (2011.09 -2016.10), X 1 [E 84] (D) 135 Kw (2012.07 -2015.06), 3 [F 30] (D) 135 Kw (2012.02 -2016.03), X 3 [F 25] (D) 155 Kw (2011.04 -2017.08), X 5 [F 15], X 6 [F 16]	11428507683		1,205.00
F 026 407 126	Oil Filter Element		LAND ROVER GROUP- Range Rover Sport [LS,L320] (D) 200 Kw (2006.04 -2009.08), Range Rover III [LM,L322] (D) 200 Kw (2006.09 -2009.08), Range Rover III [LM,L322] (D) 200 Kw (2009.09 -2013.01)			On Request
F 026 407 132	Oil Filter Element		MERCEDES-BENZ- C-Klasse [204] (P) 135 Kw (2009.04 -2014.12)	2711800509		876.00
F 026 407 144	Oil Filter Element		SKODA- Fabia [5J2, 542] (D) 55 Kw (2010.03 -2014.12)			688.00
F 026 407 144	Oil Filter Element		VOLKSWAGEN- Polo [6R1] (D) 55 Kw (2013.09 -2014.09)	03P115562		688.00
F 026 407 147	Oil Filter Element		HYUNDAI- Elantra [MD, UD], i20 [PB, PBT], i20 [IB] Active, i20 [GB]	263202A501		On Request

### Filter Application Chart

Part Number	Product Description	Image	Model Description 	Potential OE Part No	Potential Comp. Part No	MRP (₹)
F 026 407 155	Oil Filter Element		JAGUAR- XJ [X351] (D) 202 Kw (2010.08 -2015.07), XF [X250] (D) 202 Kw (2009.03 -2015.10)	JDE8751	LRG -LR013148; JAG -JDE8751	On Request
F 026 407 155	Oil Filter Element		LAND ROVER GROUP- Range Rover IV [LG,L405] (D) 155 Kw (2017.01 -2021.08), Range Rover IV [LG,L405] (D) 183 Kw (2013.02 -2021.08), Discovery IV [LA,L319] (D) 190 Kw (2017.10 -2017.12), Range Rover Sport [LS,L320] (D) 183 Kw (2011.06 -2013.08), Range Rover Sport [LW,L494] (D) 215 Kw (2013.09 -2020.09), Range Rover Sport [LW,L494] (D) 183 Kw (2013.09 -2020.09)	LR013148	LRG -LR013148; JAG -JDE8751	On Request
F 026 407 156	Oil Filter Element		HYUNDAI- Santa Fe [DM]	263202F100		On Request
F 026 407 158	Oil Filter Element		ROLLS-ROYCE- Wraith [RR5], Dawn [RR6], Ghost [RR4]			On Request
F 026 407 158	Oil Filter Element		BMW- X 6 [E 71] (P) 408 Kw (2009.09 -2014.06), X 5 M [F 85], 5 [F 10] (P) 412 Kw (2011.09 -2016.10), X 6 M [F 86], 7 [F 02] (P) 400 Kw (2009.09 -2015.04), X 5 [E 70] (P) 300 Kw (2010.04 -2013.06), 6 [F 14] Gran Coupe, 6 [F 12] Cabrio (P) 300 Kw (2011.03 -2014.01), 6 [F 13] Coupe (P) 300 Kw (2011.10 -2012.06), 7 [G 12] (P) 330 Kw (2015.11 -2018.12), 7 [G 12] (P) 448 Kw (2017.05 -2018.12), X 6 [E 71] (P) 300 Kw (2008.05 -2014.06), 7 [F 02] (P) 300 Kw (2008.11 -2012.06), 7 [G 12] (P) 442 Kw (2016.09-->), 6 [F 06] Gran Coupe (P) 330 Kw (2012.07 -2018.10)	11427583220, 11427848321		On Request









### Filter Application Chart

Part Number	Product Description	Image	Model Description 	Potential OE Part No	Potential Comp. Part No	MRP (₹)
F 026 407 173	Oil Filter Element		BMW- 1 [F 20] (P) 100 Kw (2013.09 -2015.02)	11427635557		On Request
F 026 407 175	Oil Filter Element		BMW- 3 [F 30] (P) 160 Kw (2012.02 -2015.08), 3 [F 30] (P) 135 Kw (2012.03 -2018.10), 5 [F 10] (P) 135 Kw (2012.01 -2013.09)	11427953125		On Request
F 026 407 178	Oil Filter Element		BMW- 5 [F 10] (P) 135 Kw (2012.01 -2013.09)	11427634291		On Request
F 026 407 204	Oil Filter Element		BMW Mini- Mini [F 57] Cabrio, Mini [F 54] Clubman, Mini [F 56] (P) 120 Kw (2014.03 -2018.06), Mini [F 56] (D) 85 Kw (2014.03 -2018.02)			On Request
F 026 407 204	Oil Filter Element		BMW- X 1 [F 48] (D) 120 Kw (2015.10 -2019.07), X 1 [F 48] (P) 141 Kw (2017.05 -2018.03), X 1 [F 48] (D) 120 Kw (2015.11 -2019.07), i 8 [I 12]	11428570590		On Request
F 026 407 205	Oil Filter Element		BMW- 3 [G 20], 5 [G 30], 7 [G 12] (P+E) 190 Kw (2016.07 -2019.02), X 3 [F 25] (D) 120 Kw (2014.04 -2017.08), 3 [F 30] (P) 135 Kw (2015.07 -2018.10), 5 [F 10] (D) 120 Kw (2014.06 -2016.10)	11428575211		On Request
F 026 407 228	Oil Filter Element		BMW- 5 [F 10] (P) 225 Kw (2010.09 -2016.10), 5 [F 10] (P) 225 Kw (2010.03 -2016.10)	11427634292		On Request
F 026 407 231	Oil Filter Element		MERCEDES-BENZ- A-Klasse [177] Limousine, GLA-Klasse [247]	2811800210		On Request









### Filter Application Chart

Part Number	Product Description	Image	Model Description 	Potential OE Part No	Potential Comp. Part No	MRP (₹)
F 026 407 238	Oil Filter Element		MERCEDES-BENZ- C-Klasse [205] (D) 110 Kw (2018.10-->), E-Klasse [213], S-Klasse [223], GLE-Klasse [167], GLC-Klasse [253] (D) 180 Kw (2019.04 -2022.05), G-Klasse [463] (D) 210 Kw (2019.01-->)	6541801100		On Request
F 026 407 255	Oil Filter Element		BMW- 3 [E 93] Cabrio (P) 309 Kw (2008.03 -2013.10), 3 [E 92] Coupe	11427837997		On Request
F 026 407 258	Oil Filter Element		JEEP- Grand Cherokee [WK2]			On Request
F 026 407 264	Oil Filter Element		BMW- X 7 [G 07], 8 [G 16] Gran Coupe, 7 [G 12] (D) 155 Kw (2015.09 -2020.06)	11427826799		On Request
F 026 407 269	Oil Filter Element		JAGUAR- F-Type Cabriolet [X152], XF [X250] (P) 346 Kw (2009.02 -2015.10), F-Type Coupe [X152], XF [X250] (P) 346 Kw (2009.02 -2013.07), F-Pace [X761] (P) 280 Kw (2015.09 -2020.08), XK [X150] Convertible, F-Pace [X761] (P) 405 Kw (2020.09-->), XJ [X351] (P) 375 Kw (2010.08 -2019.07), XF [X250] (P) 283 Kw (2009.02 -2012.08), XJ [X351] (P) 283 Kw (2009.11 -2013.10), XK [X150] Coupe	C2D3670	LRG -LR011279; JAG -C2D3670	On Request

### Filter Application Chart

Part Number	Product Description	Image	Model Description 	Potential OE Part No	Potential Comp. Part No	MRP (₹)
F 026 407 269	Oil Filter Element		LAND ROVER GROUP- Range Rover IV [LG,L405] (P) 375 Kw (2012.11 -2018.04), Range Rover Sport [LS,L320] (P) 372 Kw (2009.09 -2013.08), Range Rover IV [LG,L405] (P) 405 Kw (2015.06 -2017.08), Range Rover III [LM,L322] (P) 375 Kw (2009.09 -2013.01), Range Rover Sport [LW,L494] (P) 375 Kw (2013.10 -2018.04), Discovery IV [LA,L319] (P) 180 Kw (2009.07 -2017.12), Range Rover IV [LG,L405] (P) 386 Kw (2017.09 -2020.08), Range Rover Sport [LW,L494] (P) 280 Kw (2015.06 -2019.09), Range Rover IV [LG,L405] (P) 416 Kw (2017.04 -2020.08)	LR011279	LRG -LR011279; JAG -C2D3670	On Request
F 026 407 270	Oil Filter Element		AUDI- Q7 [4MB, 4MG] (D) 183 Kw (2015.06 -2019.12)			On Request
F 026 407 274	Oil Filter Element		AUDI- A8 [4N, D5], S5 [F5A, F5F] Sportback, Q7 [4MB, 4MG] (P+E) 250 Kw (2019.07-->)			On Request
F 026 407 274	Oil Filter Element		PORSCHE- Macan [95B] (P) 280 Kw (2021.09-->), Macan [95B] (P) 324 Kw (2021.09-->)	9A719840500		On Request
F 026 407 275	Oil Filter Element		JAGUAR- F-Pace [X761] Diesel and electric engine 120 Kw (2020.10-->), XE [X760], XF Sportbrake [X260], F-Pace [X761] (D) 132 Kw (2015.09 -2020.08)	JDE37128	JAG -JDE37128; LRG -LR073669	On Request
F 026 407 275	Oil Filter Element		LAND ROVER GROUP- Evoque [LV,L538], Discovery Sport [LC,L550]	LR073669	JAG -JDE37128; LRG -LR073669	On Request
F 026 407 277	Oil Filter Element		BMW Mini- Mini [F 56] (P) 155 Kw (2017.09 -2018.03)			On Request

### Filter Application Chart











Part Number	Product Description	Image	Model Description 	Potential OE Part No	Potential Comp. Part No	MRP (₹)
F 026 407 277	Oil Filter Element		BMW- X 1 [F 48] (D) 140 Kw (2017.11-->), 2 [F 44] Gran Coupe, X 1 [F 48] (P) 141 Kw (2019.09-->)	11428593186		On Request
F 026 407 278	Oil Filter Element		AUDI- A6 [4G, C7], A3 [8VS, 8VM] Limousine, Q2 [GAB, GAG], TT [FV3, FVP] Coupe, Q7 [4MB, 4MG] (P) 185 Kw (2017.09 -2019.12), A3 [8V7, 8VE] Cabriolet; SKODA- Octavia [5E3], Superb [3V3]			On Request
F 026 407 278	Oil Filter Element		VOLKSWAGEN- TIGUAN BS-VI 4WD	06L115562B		On Request
F 026 407 278	Oil Filter Element		PORSCHE- Macan [95B] (P) 174 Kw (2015.10 -2018.08), Macan [95B] (P) 195 Kw (2021.09-->)	95811556200, 95811556201		On Request
F 026 407 312	Oil Filter Element		PORSCHE- Boxster [987] (P) 235 Kw (2010.09 -2012.09), Cayman [987C] (P) 235 Kw (2009.02 -2012.12), Boxster [981], Cayman [987C] (P) 243 Kw (2010.02 -2012.12), Boxster [987] (P) 188 Kw (2009.02 -2012.09), Cayman [981C]	0PB115466A		On Request
F 026 407 313	Oil Filter Element		AUDI- A8 [4H, D4] (P) 320 Kw (2013.10 -2018.01), RS7 [4G, C7] Sportback, S6 [4G, C7], RS6 [4G, C7] Avant, A8 [4H, D4] (P) 309 Kw (2013.07 -2014.04); BENTLEY- Continental GT [393] (P+A) 388 Kw (2016.05 -2017.11), Flying Spur [4W] (P) 373 Kw (2014.02 -2015.08), Continental GT [393] (P) 373 Kw (2012.01 -2014.12)			On Request
F 026 407 314	Oil Filter Element		PORSCHE- 718 Boxster [982], 718 Cayman [982C]	9A210722500, 0PC115466		On Request

### Filter Application Chart









Part Number	Product Description	Image	Model Description 	Potential OE Part No	Potential Comp. Part No	MRP (₹)
F 026 407 319	Oil Filter Element		MERCEDES-BENZ- S-Klasse [222] Maybach (P) 390 Kw (2014.12 -2017.06), S-Klasse [221] (P) 380 Kw (2005.12 -2013.06), S-Klasse [222] Maybach (P) 463 Kw (2017.07 -2020.09), S-Klasse [222], CL-Klasse [216] (P) 380 Kw (2006.09 -2014.12)	2751800009		On Request
F 026 407 320	Oil Filter Element		SKODA- Superb [3T4] (P) 191 Kw (2008.11 -2015.05)			On Request
F 026 407 320	Oil Filter Element		PORSCHE- Cayenne [92A] (P) 220 Kw (2010.07 -2014.08)	95810722210		On Request
F 026 407 341	Oil Filter Element		MERCEDES-BENZ- S-Klasse [221] (P) 386 Kw (2006.12 -2010.07), SLS-Klasse [197] Coupe, C-Klasse [204] (P) 336 Kw (2008.02 -2014.12), CL-Klasse [216] (P) 386 Kw (2007.01 -2010.07)	0001803009		On Request
F 026 407 344	Oil Filter Element		BENTLEY- Continental Flying Spur [3W], Continental GT [393] (P) 412 Kw (2003.06 -2012.10), Flying Spur [4W] (P+A) 453 Kw (2013.03 -2015.05), Continental GT [393] (P+A) 460 Kw (2012.09 -2014.05); AUDI- A8 [4H, D4] (P) 368 Kw (2011.01 -2014.04), A8 [4E, D3] (P) 331 Kw (2004.02 -2010.07), A8 [4H, D4] (P) 368 Kw (2013.09 -2018.01)			On Request
F 026 407 345	Oil Filter Element		MERCEDES-BENZ- S-Klasse [222] Maybach (P) 345 Kw (2017.07 -2020.09)	1761800800		On Request
F 00E 369 874	Oil Filter Element Eco		MERCEDES-BENZ- E-Klasse [207] Cabrio, M-Klasse [164], CLS-Klasse [219], R-Klasse [251], CL-Klasse [216], C-Klasse [203], SL-Klasse [230], G-Klasse [463], SLK-Klasse [172], SLK-Klasse [171], E-Klasse [207] Coupe			905.00











### Filter Application Chart

Part Number	Product Description	Image	Model Description 	Potential OE Part No	Potential Comp. Part No	MRP (₹)
0 986 MF2 356	Oil Filter Element Mx Premium		MERCEDES-BENZ- SLK-Klasse [172]			On Request
0 451 103 079	Oil Filter Spin-on		OPEL- Corsa 1.4i Swing Hatchback, Corsa 1.6i Sail Hatchback, Corsa 1.4i, Corsa 1.6i, Corsa 1.4i Sail Hatchback	93156300		299.00
0 451 103 300	Oil Filter Spin-on		FIAT- Punto 1.4i	46808398		On Request
0 451 103 313	Oil Filter Spin-on		SKODA- Superb [3U4]; AUDI- A6 [AU561]			986.00
0 451 103 314	Oil Filter Spin-on		AUDI- TT [8N3] Coupe (P) 110 Kw (2001.01 -2006.06); SKODA- Octavia [1U2]			On Request
0 451 103 314	Oil Filter Spin-on		VOLKSWAGEN- New Beetle [1C1, 9C1] (P) 85 Kw (2001.06 -2010.09)	06A115561B		On Request
0 451 103 316	Oil Filter Spin-on		HYUNDAI- Accent 1.6i 16V, Elantra [MD, UD], i20 [BC3] (P) 62 Kw (2020.08-->), Sonata [NF], Sonata [YF]	2630035505		On Request
0 451 103 354	Oil Filter Spin-on		FIAT- Palio [178] Weekend, Palio [178], Siena [178], Uno '98 [146]	46805832		485.00
0 451 103 370	Oil Filter Spin-on		OPEL- Astra F [T92]	95509857		On Request







### Filter Application Chart

Part Number	Product Description	Image	Model Description 	Potential OE Part No	Potential Comp. Part No	MRP (₹)
0 986 452 003	Oil Filter Spin-on		NISSAN- X-Trail [T30]	15208BN30A		1,450.00
0 986 452 036	Oil Filter Spin-on		HONDA- City [2CT] (P) 66 Kw (1998.01 -2003.10)	15400PR3004		On Request
0 986 452 044	Oil Filter Spin-on		TOYOTA- Fortuner [N5,N6], Innova 2.0i, Land Cruiser Prado [J12], Camry 2.4, Innova 2.0, Camry 2.4 i Sedan (P) 123 Kw (2006.01 -2011.09), Innova 2.0 CNG, Fortuner 3.0 Diesel Turbo, Corolla [E15], Fortuner 2.5 D-4D	90915TB001, 90915YZZJ4, 9091520003, 90915YZZJ3		494.00
0 986 AF1 043	Oil Filter Spin-on		TOYOTA- Camry 2.4 i Sedan (P) 123 Kw (2006.01 -2011.09)			On Request
0 986 MF0 081	Oil Filter Spin-on		AUDI- TT [8N3] Coupe (P) 110 Kw (2001.01 -2006.06); VOLKSWAGEN- Jetta [9M2], New Beetle [1C1, 9C1] (P) 85 Kw (2001.06 -2010.09)			On Request
9 451 037 446	Oil Filter Spin-on		MAHINDRA- MM 540/550 DP 2.1 Diesel 4WD, MM 2.1i 4WD, MM 540/550 XDB 2.5 Diesel, MM 540/550 DP 2.1 Diesel, Armada Grand 2.5 Diesel, MM 540 XDB 4x4, CL 340 DP 2.1 Diesel 4WD, Armada 2.1 Diesel, MM 540/550 XDB 2.5 Diesel 4WD, Marshal 2.1 Diesel			301.00
9 951 030 134	Oil Filter Spin-on		TATA MOTORS- Sumo 1.9 Diesel	254718130117		301.00
F 002 H20 236	Oil Filter Spin-on		TATA MOTORS- 207 DI 3.0 Diesel (D) 48 Kw (2002.05 -2013.06), 207 DI Crew Cab, Sumo 3.0 Diesel, 207 DI EX (D) 48 Kw (2005.05 -2013.07)	254718130115	FLG -LF16070	286.00





### Filter Application Chart

Part Number	Product Description	Image	Model Description 	Potential OE Part No	Potential Comp. Part No	MRP (₹)
F 002 H20 244	Oil Filter Spin-on		MAHINDRA- Major 2.5 Diesel			232.00
F 002 H20 264	Oil Filter Spin-on		TATA MOTORS- Indica 1.4 Diesel, Indica 1.4i	279018130104, 279018130101, 279018130102, G279018130103, 279018130105		220.00
F 002 H20 371	Oil Filter Spin-on		HYUNDAI- Eon 1.0 Magna Plus, Santro 1.0i 12V (P+GAS) 46 Kw (2007.07 -2014.11), Santro 1.1 i 12V (P) 46 Kw (2002.03 -2003.07), Santro 1.0i 12V (P) 40 Kw (1998.09 -2002.01), Eon 0.8 i, Grand i10 1.2, Grand i10 1.1 CRDi, Xcent 1.2			178.00
F 002 H20 377	Oil Filter Spin-on		MARUTI- Baleno 1.6i, Zen 1.0i 16V, Baleno Altura 1.6i, Versa 1.3i 16V, Alto 800 CNG, 800 0.8 i 6V, Swift 1.3i, Wagon R 1.1i 16V, Alto 1.1i 16V, Alto 0.8i 12V (P) 35 Kw (2006.02 -2012.10), 800 0.8i 12V	16510M82713, 16510M68K10, 16510M68K00, 16510M73080, 16510M82703		190.00
F 002 H23 412	Oil Filter Spin-on		CHEVROLET- Tavera 2.5D			609.00
F 002 H23 413	Oil Filter Spin-on		TOYOTA- Innova 2.5 CRDi	90915TB001, 9091520003		346.00
F 002 H23 432	Oil Filter Spin-on		SUZUKI- Baleno 1.3 TD			268.00
F 002 H23 432	Oil Filter Spin-on		MARUTI- SX4 1.3D, Vitara Brezza 1.2, Ertiga 1.3 TD Generation I, Ciaz 1.3 TD	16500M86J20, 16510M86J20		268.00









### Filter Application Chart

Part Number	Product Description	Image	Model Description 	Potential OE Part No	Potential Comp. Part No	MRP (₹)
F 002 H23 434	Oil Filter Spin-on		TATA MOTORS- 1.4TD eV2, Indigo 1.4D eCS, Indigo Marina 1.4TD (D) 51 Kw (2005.06 -2010.03), Indica 1.4 Turbodiesel (D) 50 Kw (2005.10 -2010.01), Indigo 1.4i (D) 51 Kw (2007.02 -2011.01), Indigo Marina 1.4TD (D) 46 Kw (2004.09 -2005.05), Indigo Marina 1.4 Diesel 16V, Indigo 1.4D CS, Indigo Manza 1.2 TD, Indica 1.4 Diesel 8V (D) 50 Kw (2008.05 -2010.01), Indigo 1.4D, Indigo 1.4i eCS	279018130104, 59063972, 279018130101, 279018130102, 279018130106, 570318139905, 570318139923, 279818130101, 55197218, 279018130105		358.00
F 002 H23 439	Oil Filter Spin-on		MAHINDRA- Scorpio 2.6 Diesel Turbo 4WD, Scorpio 2.6 Diesel Turbo, XYLO 2.5 TD MDI, Bolero 2.5 BS III, Bolero Invader 2.5 Diesel, Bolero Invader 2.5 Diesel 4WD, Bolero XL 2.5 Diesel, Scorpio 2.2 TD 4WD, Bolero 2.5 Diesel 4WD, Bolero 2.5 Diesel, Bolero XLS 2.5 Diesel, XYLO 2.2 TD mHawk, XUV500 2.2D, Scorpio 2.2 TD 4x4, Marazzo 1.5, Bolero Invader GLX 2.5 Diesel, Scorpio 2.2 TD, Bolero Invader GLX 2.5 Diesel 4WD, XUV500 2.2D 4x4, XYLO, Bolero 2.5 BS II, XYLO 2.5 TD mEagle, Scorpio 2.6 CRDe	9420000073, 9420000074, 0303BAM00350N, 0303BC0071N, 0303BC0010N, 71817, 24772, 0303BC0073N, 0303BAU00110N		219.00
F 002 H23 439	Oil Filter Spin-on		MAHINDRA- Scorpio 2.6 Diesel Turbo, Scorpio 2.6 Diesel Turbo 4x4	9420000073, 9420000074, 0303BAM00350N, 0303BC0071N, 0303BC0010N, 71817, 24772, 0303BC0073N, 0303BAU00110N		219.00
F 002 H23 467	Oil Filter Spin-on		HONDA- Civic 1.8i, Accord 2.3i 16V, Accord 3.0i, CR-V 2.4i 4WD, City 1.5i 16V VTEC, CR-V 2.0i 4WD, City 1.5i 16V (P) 87 Kw (2008.09 -2013.12), City 1.5, City 1.5i ZX VTEC, CR-V 2.0i, CR-V 2.4 4WD, Accord 3.5i, Accord 2.4i 16V, City 1.5 i 8V (P) 57 Kw (2003.10 -2006.12), Civic 1.3i 16V	15400PH1F03, 15400PR3014, 15400RAFT01, 15400RZ0G01, 15400RTA004, 15400PLC004, 154005Z8E01, 15400RTA003, 15400PMET01, 16010ST5933, 15400P3RE01		295.00
F 002 H23 470	Oil Filter Spin-on		HYUNDAI- i10 [IA] (P+GAS) 49 Kw (2013.09 -2020.03), i20 1.2i 16V, i10 1.2 i 16V, i10 1.1 i			260.00











### Filter Application Chart

Part Number	Product Description	Image	Model Description 	Potential OE Part No	Potential Comp. Part No	MRP (₹)
F 002 H23 490	Oil Filter Spin-on		HYUNDAI- Verna 1.6i 16V, Accent 1.6 i, Accent 1.5 CRDi, Getz 1.3 i, Sonata 2.0i 16V, Sonata 2.7i, Verna 1.6i, Accent 1.5 CNG, Elantra 1.8 i, Getz 1.1 i			267.00
F 002 H23 550	Oil Filter Spin-on		SUZUKI- Baleno 1.2			167.00
F 002 H23 550	Oil Filter Spin-on		MARUTI- Dzire 1.2, Celerio 1.0 VXi Green CNG, Celerio 1.0, Alto 0.8i, A-Star 1.0i 12V, Alto 800, Ritz 1.2 Generation I, Ertiga 1.4 CNG Generation I, Swift 1.2, Alto 0.8i 12V (P) 33 Kw (2000.09 -2006.01), Swift 1.2i, Swift 1.2i Dzire, Swift 1.3i Dzire, Baleno 1.2, Eeco 1.2i, Ciaz 1.4 Generation I, Ertiga 1.4 Generation I	16510M68K10, 16510M68K00, 16510M82703		167.00
F 002 H23 551	Oil Filter Spin-on		MAHINDRA- Logan 1.4i, Logan 1.5 Diesel	7700274177, 8200768927, 8671002274, 8200768913		270.00
F 002 H23 566	Oil Filter Spin-on		TATA MOTORS- 207 DI 3.0 Diesel (D) 48 Kw (2002.05 -2013.06), Safari 2.2, 207 DI EX (D) 48 Kw (2005.05 -2013.07)		FLG -LF16056	425.00
F 002 H23 566	Oil Filter Spin-on		TATA MOTORS- Winger 1.9 Diesel		FLG -LF16056	425.00
F 002 H24 311	Oil Filter Spin-on		MARUTI- Omni 0.8 Generation I, Zen 1.1 Estilo, Gypsy 1.3 4WD, Omni 0.8 LPG Generation II, Esteem 1.3i, 1000 1.0i 8V, Zen 1.0i, Gypsy 1.0 4WD, Omni 0.8 Generation II, Gypsy 1.3i 4WD, 800 0.8i 6V, 800 LPG	16510M73080, 16510M73013, 16510M82703, 16510M73010		148.00







### Filter Application Chart

Part Number	Product Description	Image	Model Description 	Potential OE Part No	Potential Comp. Part No	MRP (₹)
F 002 H24 495	Oil Filter Spin-on		TATA MOTORS- Nano 0.6i, Nano 0.6i CNG, Nano Twist 0.6, Nano 0.6	570518130102		193.00
F 002 H24 521	Oil Filter Spin-on		CHEVROLET- Beat 1.2i	J25181616, J96980028		294.00
F 002 H24 987	Oil Filter Spin-on		HONDA- Mobilio 1.5 TD, Amaze First Gen 1.5	15400RZ0G01, 154005Z8E01		347.00
F 002 H26 361	Oil Filter Spin-on		TATA MOTORS- Sierra 1.9 Turbodiesel 4WD	252518130164		1,995.00
F 002 H26 539	Oil Filter Spin-on		MAHINDRA- Scorpio SUV 2.2 CRDe, KUV100 1.2, Quanto 1.5D, KUV100 1.2 D75, MARAZZO 1.5 BS6, Scorpio 2.5D	0303BAM00350N	MHL -OC1692	268.00
F 002 H60 001	Oil Filter Spin-on		TATA MOTORS- Indica 1.4 Turbodiesel (D) 50 Kw (2005.10 -2010.01), Indigo 1.2i, Indigo Marina 1.4i, Indigo 1.4 Turbodiesel, Indica 1.4 Diesel 8V (D) 50 Kw (2008.05 -2010.01), Indigo 1.2i eCS CNG, Indigo 1.4i (P) 63 Kw (2006.09 -2009.10), ZEST 1.2 T, Indigo 1.2i CS, Indica 1.2i 8V, Bolt 1.2 T, Indigo Marina 1.4TD (D) 46 Kw (2004.09 -2005.05), Indigo 1.2i eCS, Indica 1.2 CNG	279018130104, 279018130106, G279018130103, 279018130105		505.00
F 002 H60 003	Oil Filter Spin-on		TATA MOTORS- Sumo 3.0D Spacio			239.00
F 026 407 022	Oil Filter Spin-on		NISSAN- Micra [K13K] (D) 47 Kw (2010.11-->)	1520800Q0D		517.00

### Filter Application Chart



Part Number	Product Description	Image	Model Description 	Potential OE Part No	Potential Comp. Part No	MRP (₹)
F 026 407 022	Oil Filter Spin-on		DACIA- Duster [HS], Lodgy [JS] (D) 79 Kw (2012.03 -2018.12); RENAULT- Laguna III [BT], Duster dCi, Duster [HS], Fluence [L3] (D) 78 Kw (2009.11 -2016.12), Duster 1.5 TD	8200768927		517.00
F 026 407 077	Oil Filter Spin-on		HONDA- City 1.5i 16V (P) 87 Kw (2008.09 -2013.12), Jazz [2TF], City [2CT] (P) 66 Kw (1998.01 -2003.10), City 1.5 i 8V (P) 57 Kw (2003.10 -2006.12)	15400PH1F03, 15400RTA004, 15400PMET01, 15400RTA003		On Request
F 026 407 078	Oil Filter Spin-on		FORD- EcoSport '14 [JK8]; VOLVO- V40 [526] Cross Country		MOT -EFL10	On Request
F 026 407 080	Oil Filter Spin-on		AUDI- TT [8J3] Coupe			On Request
F 026 407 142	Oil Filter Spin-on		HYUNDAI- i20 [BC3] (P) 88 Kw (2020.08-->)	2630002503		On Request
F 026 407 176	Oil Filter Spin-on		DACIA- Lodgy [JS] (D) 66 Kw (2012.03 -2018.12)	152085488R		On Request
F 026 407 181	Oil Filter Spin-on		VOLKSWAGEN- Polo [6R1] (P) 77 Kw (2013.04 -2014.05)	03C115561J		On Request
F 026 407 183	Oil Filter Spin-on		SKODA- Fabia 1.6 i, Rapid 1.6, Fabia [5J2, 542]			655.00
F 026 407 183	Oil Filter Spin-on		VOLKSWAGEN- Polo 1.6, Vento 1.6 MPI, VENTO BS-VI, Polo [6R1] (P) 77 Kw (2013.04 -2014.05), Jetta [162]	03C115561H, 03C115561D		655.00

### Filter Application Chart

Part Number	Product Description	Image	Model Description 	Potential OE Part No	Potential Comp. Part No	MRP (₹)
F 026 407 203	Oil Filter Spin-on		FORD- Mondeo '01 [B4Y]		MOT -FL2100; LRG -LR096524; JAG -C2Z32125	On Request
F 026 407 203	Oil Filter Spin-on		JAGUAR- XJ [X351], XE [X760], XF [X250]	C2Z32125		On Request
F 026 407 203	Oil Filter Spin-on		LAND ROVER GROUP- Evoque [LV,L538], Discovery Sport [LC,L550]	LR096524		On Request
F 026 407 209	Oil Filter Spin-on		RENAULT- Fluence [L3] (P) 103 Kw (2010.02 -2016.12)	152085758R		On Request
F 026 407 209	Oil Filter Spin-on		NISSAN- Micra [K13K] (P) 59 Kw (2010.05 -2015.10), Teana 2.5i, 370 Z [Z34] Coupe	1520865F0B, 152081HCOA		On Request
F 026 407 209	Oil Filter Spin-on		HYUNDAI- i10 [IA] (P+GAS) 49 Kw (2013.09 -2020.03), Santro 1.1 i 12V (P) 46 Kw (2002.03 -2003.07), Santro 1.0i 12V (P) 40 Kw (1998.09 -2002.01), i10 [PA], Elite i20 [IB]	2630002752		On Request
F 026 407 268	Oil Filter Spin-on		CITROEN- C5 Aircross [C84]	9809532380		On Request
F 026 407 304	Oil Filter Spin-on		ISUZU- D-Max		MN -W8018	On Request
F 026 407 306	Oil Filter Spin-on		LEXUS- ES [Z]			On Request













### Filter Application Chart

Part Number	Product Description	Image	Model Description 	Potential OE Part No	Potential Comp. Part No	MRP (₹)
F 026 407 332	Oil Filter Spin-on		HYUNDAI- Accent [LC]	2631027200		On Request











### NPI Filter Application Chart

Part Number	Product Description	Image	Model Description 	Potential OE Part No	Potential Comp. Part No	MRP (₹)
F 002 H20 378	Air Filter Element, Engine		MARUTI- Alto 0.8i 12V, Alto 0.8i, Alto 1.1i 16V, Wagon R 1.1i 16V	13780M79F00		330.00
F 002 H23 418	Air Filter Element, Engine		TOYOTA- Innova 2.0 CNG (P+GAS) 100 Kw (2009.02 -2013.05), Innova 2.5 CRDi (D) 75 Kw (2004.12 -2019.01)	J1322083	ELF -EK5059	810.00
F 002 H23 427	Air Filter Element, Engine		MARUTI- Ritz 1.2 Generation I (P) 63 Kw (2009.05 -2012.07), Ertiga 1.4 CNG Generation I, Swift 1.2, Swift 1.2i, Swift 1.2i Dzire, Swift 1.3i, Swift 1.3i Dzire, Swift 1.3 TD (D) 56 Kw (2007.01 -2011.07), A-Star 1.0i 12V, Ciaz 1.4 Generation I, Ertiga 1.4 Generation I	13780M83K00, 13780M75J00, 13780M74L00		314.00
F 002 H23 585	Air Filter Element, Engine		MAHINDRA- XYLO 2.2 TD mHawk, XYLO 2.5 TD MDI, XYLO, XYLO 2.5 TD mEagle	0313AAC04390N		977.00
F 002 H23 595	Air Filter Element, Engine		HYUNDAI- i10 1.1 i			300.00
F 002 H23 596	Air Filter Element, Engine		HYUNDAI- i20 1.2i 16V, i20 1.4 TD, i20 1.2i, i20 [PB, PBT]	281131J000, 28113C7000		480.00
F 002 H24 971	Air Filter Element, Engine		TOYOTA- Etios Cross 1.2 G, Etios 1.4D Liva, Etios 1.4D, Etios Cross 1.4TD	178010N050		315.00
F 002 H24 977	Air Filter Element, Engine		HYUNDAI- Eon 0.8 i	281134N000		244.00

### NPI Filter Application Chart

Part Number	Product Description	Image	Model Description 	Potential OE Part No	Potential Comp. Part No	MRP (₹)
F 002 H24 978	Air Filter Element, Engine		MARUTI- Alto 800 CNG, Alto 800	13870M53M00, 13870M53M30		230.00
F 002 H24 979	Air Filter Element, Engine		MARUTI- Celerio 1.0, Alto 1.0i, Alto 1.0 CNG/LPG	13780M65L00, 13780M76M00		265.00
F 002 H24 982	Air Filter Element, Engine		MARUTI- Vitara Brezza 1.2	13780M82P50		425.00
F 002 H26 329	Air Filter Element, Engine		MARUTI- Versa 1.3i 16V, Eeco 1.2i	13780M83B00		300.00
F 002 H26 332	Air Filter Element, Engine		SUZUKI- Baleno 1.3 TD; MARUTI- Baleno 1.2			315.00
F 002 H26 334	Air Filter Element, Engine		HYUNDAI- i10 1.2 i 16V	281130X200		305.00
F 002 H26 339	Air Filter Element, Engine		HYUNDAI- Creta 1.4 TD, Creta 1.6 CRDi	28113A0200		337.00
F 002 H26 395	Air Filter Element, Engine		TATA MOTORS- Tiago 1.0 BS IV Multi Drive, TIGOR 1.0	570709130114, 570709130105		412.00
F 002 H26 396	Air Filter Element, Engine		HYUNDAI- Creta 1.6	28113A0100		370.00









### NPI Filter Application Chart

Part Number	Product Description	Image	Model Description 	Potential OE Part No	Potential Comp. Part No	MRP (₹)
F 002 H27 540	Air Filter Element, Engine		MARUTI- Wagon R 1.0, Wagon R 1.0i LPG, Zen 1.0i Estilo CNG, Zen 1.0i Estilo			250.00
F 002 H27 541	Air Filter Element, Engine		RENAULT- Kwid 0.8			220.00
F 026 400 223	Air Filter Element, Engine		HONDA- Jazz 1.2, City 1.5 i 8V, City 1.5, Jazz [2TF], City 1.5i 16V	17220RB0000, 17220REAZ00, 17220RNYE01, 17220RB6Z00		836.00
F 026 400 289	Air Filter Element, Engine		AUDI- A6 [4G, C7]			1,310.00
F 026 400 365	Air Filter Element, Engine		BMW- 5 [F 10] (D) 160 Kw (2011.09 -2016.10), 5 [F 10] (D) 150 Kw (2010.03 -2011.08), 5 [F 07] GT, 5 [F 10] (D) 180 Kw (2010.03 -2011.08), 7 [F 02], 5 [F 10] (D) 100 Kw (2010.05 -2016.10)	13717800151		4,175.00
F 026 400 366	Air Filter Element, Engine		BMW- X 5 [E 70] (D) 155 Kw (2010.04 -2013.06), X 6 [E 71], X 3 [F 25]	13717811026		4,223.00
F 026 400 374	Air Filter Element, Engine		BMW- 3 [F 30] (P) 160 Kw (2012.02 -2015.08), 3 [F 30] (P) 135 Kw (2012.03 -2018.10), 3 [F 30] (D) 135 Kw (2012.02 -2016.03), 3 [F 34] GT, 1 [F 20]	13718511668		1,751.00
F 026 400 379	Air Filter Element, Engine		MERCEDES-BENZ- GLA-Klasse [156], CLA-Klasse [117], B-Klasse [246], A-Klasse [176]	6510940204		1,020.00
1 987 435 058	Cabin Filter		MERCEDES-BENZ- EQC-Klasse [293], E-Klasse [213], C-Klasse [205], GLS-Klasse [166], GLC-Klasse [253], GLE-Klasse [166], GLC-Klasse [253] Coupe, GL-Klasse [166]	1668300218		2,322.00

### NPI Filter Application Chart

Part Number	Product Description	Image	Model Description 	Potential OE Part No	Potential Comp. Part No	MRP (₹)
F 002 H24 938	Cabin Filter		MARUTI- Alto 1.0i, Alto 1.0 CNG/LPG, A-Star 1.0i 12V			335.00
F 002 H24 939	Cabin Filter		SUZUKI- Baleno 1.3 TD			450.00
F 002 H24 939	Cabin Filter		MARUTI- Dzire 1.2, SX4 1.6i, Dzire BS IV, Celerio 1.0 VXi Green CNG, Swift 1.3 TD, Ertiga 1.4 CNG Generation I, Swift 1.3 Dzire TD, S-cross 1.2 (D) 66 Kw (2015.08-->), Swift 1.2, Swift 1.2i, Swift 1.2i Dzire, Baleno 1.2, Swift BS IV, Ertiga 1.3 TD Generation I, Dzire Tour S CNG 1.2, Ertiga 1.4 Generation I, Ciaz 1.3 TD	95850M55R00, 95861M74L00, 95850M79M00		450.00
F 002 H24 940	Cabin Filter		SUZUKI- S-Cross 1.6 TD, S-Cross 1.3 TD			480.00
F 002 H24 940	Cabin Filter		MARUTI- S-cross 1.2 (D) 66 Kw (2015.08-->), Vitara Brezza 1.2, S-cross 1.6 TD 2WD, Ciaz 1.4 Generation I	95850M79M00		480.00
F 002 H24 943	Cabin Filter		MARUTI- Wagon R 1.0i LPG, Wagon R 1.1i 16V			512.00
F 002 H24 945	Cabin Filter		HYUNDAI- Elite i20 1.4, Elite i20 [IB], i20 Active 1.2	97133C7100		590.00
F 002 H24 948	Cabin Filter		NISSAN- Terrano 1.6, Terrano 1.5 D	8201153808, 272773223R		378.00









### NPI Filter Application Chart

Part Number	Product Description	Image	Model Description 	Potential OE Part No	Potential Comp. Part No	MRP (₹)
F 002 H24 948	Cabin Filter		RENAULT- Duster 1.6, Duster 1.5 TD	8201153808, 272775374R, 7701062227, 272773223R		378.00
F 002 H24 983	Cabin Filter		TOYOTA- Etios Cross 1.2 G, Etios 1.4D Liva, Etios 1.5i, Etios 1.5 Liva, Etios Cross 1.5 V, Etios 1.4D, Etios 1.2i Liva, Etios Cross 1.4TD	871390D060, 871390D190		284.00
F 002 H26 399	Cabin Filter		FORD- Fusion 1.6i 16V, Fiesta 1.4 Turbodiesel, Figo 1.4D, Fusion 1.4 Diesel 8V, Fiesta 1.6i, Fiesta 1.4i, Fiesta 1.5 Turbodiesel, Figo [B517]			285.00
F 002 H26 399	Cabin Filter Micro Clean		FORD- Fusion 1.6i 16V, Fiesta 1.4 Turbodiesel, Fiesta 1.5i, Fiesta 1.5 Turbodiesel, Figo Aspire 1.5 TDCi, EcoSport 1.5 TD, Figo Aspire 1.5 Ti-VCT, EcoSport 1.5			285.00
1 987 432 405	Cabin Filter, Activated Carbon		VOLVO- S80 II [124], XC60 I [156], V60 [155], S60 II [134], S60 [134] Cross Country		JAG -C2Z32298	5,470.00
1 987 432 405	Cabin Filter, Activated Carbon		LAND ROVER GROUP- Evoque [LV,L538], Freelander [L359], Discovery Sport [LC,L550]	LR056138	JAG -C2Z32298	5,470.00
F 002 H24 990	Diesel Filter Kit (preliminary And Main Filter)		CHEVROLET- Beat 0.9D	J96896403		1,378.00
F 002 H24 496	Fuel Filter Element		MAHINDRA- XYLO 2.2 TD mHawk (D) 91 Kw (2013.05-->), Bolero Invader 2.5 Diesel 4WD (D) 40 Kw (2003.03 -2004.10), Marazzo 1.5, Thar 2.5D 4x4 (D) 47 Kw (2010.12 -2013.04), Bolero XL 2.5 Diesel, Marshal 2.5 Diesel 4WD, Bolero 2.5 Diesel (D) 47 Kw (2007.03 -2011.09), XYLO, Maxx 2.5 Diesel Pik-Up (2005), Thar 2.5 TD, Bolero 2.5 Diesel (D) 46 Kw (2011.11-->)	9420000319, 10000A0370N, 0305DAB00581N		227.00

### NPI Filter Application Chart





Part Number	Product Description	Image	Model Description 	Potential OE Part No	Potential Comp. Part No	MRP (₹)
F 002 H24 518	Fuel Filter Element		TATA MOTORS- Indica Vista 1.4i, Indigo 1.2i eCS (P) 48 Kw (2011.09 -2018.08), Indigo 1.2i (P) 74 Kw (2007.02 -2011.01), Indigo 1.4i eCS (D) 51 Kw (2011.09 -2017.06), Indica 1.4i (P) 55 Kw (2000.05 -2010.01), Indigo Manza 1.4i (P) 66 Kw (2009.10 -2011.02), Indica Vista 1.2i 8V, Indigo 1.4i (P) 63 Kw (2006.09 -2009.10), Indigo 1.2i CS, Indica 1.2i 8V, Indica 1.2 CNG	278607999845, 279109110101, 279109110102, 570107999901, 288547704905	FLG -5010516	1,055.00
F 002 H24 990	Fuel Filter Element		SUZUKI- S-Cross 1.3 TD			1,378.00
F 002 H24 990	Fuel Filter Element		MARUTI- S-cross 1.2	15411M55KD0		1,378.00
F 002 H24 990	Fuel Filter Element		CHEVROLET- Beat 0.9D	J96896403		1,378.00
F 002 H26 359	Fuel Filter Element		TATA MOTORS- Sumo 2.2D Grande (D) 88 Kw (2008.02-->), Indica 1.4 Turbodiesel (D) 50 Kw (2005.10 -2010.01), Indigo 1.2i (P) 74 Kw (2007.02 -2011.01), Indigo 1.4i (D) 51 Kw (2007.02 -2011.01), Indica 1.4i (P) 44 Kw (1998.12 -2000.04), Indigo 1.4 Turbodiesel, Safari 3.0D 4x4 Dicor (D) 85 Kw (2005.08 -2007.09), Safari 4x2 Dicor (D) 85 Kw (2005.08 -2008.12), Indigo Marina 1.4TD	279009110111, 253409110108, 253409110113		1,190.00
F 002 H24 518	Fuel Filter Spin-on		TATA MOTORS- Indica 1.4i	278607999845, 279109110101, 279109110102, 570107999901, 288547704905	FLG -5010516	1,055.00

### NPI Filter Application Chart

Part Number	Product Description	Image	Model Description 	Potential OE Part No	Potential Comp. Part No	MRP (₹)
F 002 H26 500	Fuel Filter Spin-on		HYUNDAI- Tucson 2.0 CRDi GLS AT 4WD, i20 1.4 TD, Tucson 2.0 Diesel 4WD (D) 82 Kw (2005.04 -2010.01), Creta 1.6 CRDi (D) 94 Kw (2015.10 -2021.06), Creta 1.4 TD, Grand i10 1.1 TD, Verna 1.6 TD, Verna 1.6i, Elantra 2.0 CRDi (D) 83 Kw (2004.04 -2008.12), Verna 1.6D, Elantra 1.6 TD, Verna 1.4D	319224H001		827.00
F 002 H26 514	Fuel Fine Filter Element		MAHINDRA- Scorpio 2.2 TD 4WD, Bolero 1.5 TD Power+, TUV300 1.5 TD Auto, TUV300 1.5 TD, Scorpio 2.5D, XUV500 2.2D, TUV300 T10 1.5 mHawk100, NuvoSport 1.5TD, TUV 300 Plus 2.2, Scorpio 2.2 TD, KUV100 1.2 TD, XUV500 2.2 W9, XUV500 2.2D 4x4, Scorpio 2.2 mHawk140 CRDe 2WD, Scorpio 2.2 mHawk140 CRDe 4WD			630.00
F 026 402 808	Fuel Pipe Filter		AUDI- A7 [4G, C7] Sportback, A4 [8W2, 8WC, B9]			2,137.00
1 457 429 194	Oil Filter Element		SKODA- Fabia [5J2, 542] (P) 44 Kw (2006.12 -2009.05)			450.00
1 457 429 194	Oil Filter Element		VOLKSWAGEN- Polo MPI, Ameo BS6 Corporate Edition	03D115403D, 03D198819C		450.00
9 451 037 456	Oil Filter Element		TATA MOTORS- Sumo Gold 3.0 d, Sumo 3.0D Spacio, Sumo 3.0 Diesel 8V, Sumo 3.0 Diesel BS2 Spacio (D) 48 Kw (2000.02-->)	252718130105, 253418130169	FLG -LF16059	345.00
F 002 H20 377	Oil Filter Element		MARUTI- Baleno 1.2 (P) 62 Kw (2015.10-->), Baleno 1.6i (P) 69 Kw (1999.11 -2005.10), Ertiga 1.5 Smart Hybrid Generation II, Dzire BS IV, Baleno Altura 1.6i, Swift 1.3i, Alto 800 CNG, 800 0.8 i 6V, Ignis 1.2, Alto 1.1i 16V, Swift BS IV, Celerio X 1.0 2WD	16510M82713, 16510M68K10, 16510M68K00, 16510M73080, 16510M82703		190.00









### NPI Filter Application Chart

Part Number	Product Description	Image	Model Description 	Potential OE Part No	Potential Comp. Part No	MRP (₹)
F 002 H23 434	Oil Filter Element		TATA MOTORS- Indigo 1.4D eCS, Indigo 1.2i (P) 74 Kw (2007.02 -2011.01), Indica Vista 1.2i 8V, Indigo 1.4D CS, Indica 1.2i 8V, Indigo 1.4i eCS, Indigo 1.2i CS, ZEST 1.24 TD XTA, Indigo Manza 1.4i, Indica 1.4 Diesel 8V, Indica Vista 1.3 TD, Indigo Marina 1.4 Diesel 16V, Indigo 1.4i, Indica 1.4 Turbodiesel, Indigo Manza 1.2 TD, Indigo 1.2i eCS, ZEST 1.2 TD, Indigo 1.4D, Bolt 1.2 TD, Indica 1.2 CNG	279018130104, 59063972, 279018130101, 279018130102, 279018130106, 570318139905, 570318139923, 279818130101, 55197218, 279018130105		358.00
F 002 H23 435	Oil Filter Element		HYUNDAI- Verna 1.5 CRDi			604.00
F 002 H23 439	Oil Filter Element		MAHINDRA- Scorpio 2.0i, Quanto 1.5D, XYLO 2.5 TD MDI, Bolero Invader 2.5 Diesel 4WD, Scorpio 2.2 TD 4WD, Bolero 1.5 TD Power+, Maxx 2.5 Diesel Pik-Up (2005), TUV300 1.5 TD, Scorpio 1.9TD 4x4, Bolero XLS 2.5 Diesel, XUV500 2.2D, TUV300 T10 1.5 mHawk100, Bolero Invader GLX 2.5 Diesel, KUV100 1.2 TD, Maxx 2.5 Diesel, Scorpio 2.2 mHawk140 CRDe 2WD, Bolero 2.5 BS II, XUV500 2.2D 4x4, Marshal 2.5 Diesel, Bolero 2.5 BS III, Bolero Invader 2.5 Diesel, Bolero XL 2.5 Diesel, Thar 2.5D 4x4, Bolero 2.5 Diesel, Bolero 2.5 Diesel 4WD, TUV300 1.5 TD Auto, Scorpio 2.5D, XYLO 2.2 TD mHawk, KUV100 1.2, Marazzo 1.5, XUV500 1.9TD, Scorpio 2.0, Scorpio 2.2 TD, Bolero Invader GLX 2.5 Diesel 4WD, Commander 655 2.5 Diesel 4WD, XUV500 2.2 W9, XYLO 2.5 TD mEagle, XUV300 1.5, Scorpio 2.2TD 4x4	9420000073, 9420000074, 0303BAM00350N, 0303BC0071N, 0303BC0010N, 71817, 24772, 0303BC0073N, 0303BAU00110N		219.00
F 002 H23 523	Oil Filter Element		MARUTI- Wagon R 1.0, Wagon R 1.0i LPG, Alto 1.0i, Alto 1.0 CNG/LPG, Zen 1.0i Estilo CNG, Zen 1.0i Estilo	16510M65L10		162.00





### NPI Filter Application Chart

Part Number	Product Description	Image	Model Description 	Potential OE Part No	Potential Comp. Part No	MRP (₹)
F 002 H23 550	Oil Filter Element		MARUTI- Ritz 1.2 Generation I (P) 63 Kw (2009.05 -2012.07), Celerio 1.0, Alto 0.8i, A-Star 1.0i 12V, Alto 800, Alto 0.8i 12V, Ertiga 1.4 CNG Generation I, Swift 1.2i, Swift 1.2i Dzire, Baleno 1.6i (P) 67 Kw (2005.10 -2007.04), Swift 1.3i Dzire, Eeco 1.2i, Celerio 1.0 VXi Green CNG (P+GAS) 43 Kw (2014.05-->), Ciaz 1.4 Generation I, Ertiga 1.4 Generation I	16510M68K10, 16510M68K00, 16510M82703		167.00
F 002 H26 501	Oil Filter Element		RENAULT- Kwid 0.8, Kwid 1.0	152088127R		190.00
F 026 407 132	Oil Filter Element		MERCEDES-BENZ- C-Klasse [204] (P) 135 Kw (2009.04 -2014.12)	2711800509		876.00
F 002 H20 377	Oil Filter Spin-on		MARUTI- Baleno 1.6i, Zen 1.0i 16V, Baleno Altura 1.6i, Versa 1.3i 16V, Alto 800 CNG, 800 0.8 i 6V, Swift 1.3i, Wagon R 1.1i 16V, Alto 1.1i 16V, Alto 0.8i 12V (P) 35 Kw (2006.02 -2012.10), 800 0.8i 12V	16510M82713, 16510M68K10, 16510M68K00, 16510M73080, 16510M82703		190.00
F 002 H23 434	Oil Filter Spin-on		TATA MOTORS- 1.4TD eV2, Indigo 1.4D eCS, Indigo Marina 1.4TD (D) 51 Kw (2005.06 -2010.03), Indica 1.4 Turbodiesel (D) 50 Kw (2005.10 -2010.01), Indigo 1.4i (D) 51 Kw (2007.02 -2011.01), Indigo Marina 1.4TD (D) 46 Kw (2004.09 -2005.05), Indigo Marina 1.4 Diesel 16V, Indigo 1.4D CS, Indigo Manza 1.2 TD, Indica 1.4 Diesel 8V (D) 50 Kw (2008.05 -2010.01), Indigo 1.4D, Indigo 1.4i eCS	279018130104, 59063972, 279018130101, 279018130102, 279018130106, 570318139905, 570318139923, 279818130101, 55197218, 279018130105		358.00

### NPI Filter Application Chart

Part Number	Product Description	Image	Model Description 	Potential OE Part No	Potential Comp. Part No	MRP (₹)
F 002 H23 439	Oil Filter Spin-on		MAHINDRA- Scorpio 2.6 Diesel Turbo 4WD, Scorpio 2.6 Diesel Turbo, XYLO 2.5 TD MDI, Bolero 2.5 BS III, Bolero Invader 2.5 Diesel, Bolero Invader 2.5 Diesel 4WD, Bolero XL 2.5 Diesel, Scorpio 2.2 TD 4WD, Bolero 2.5 Diesel 4WD, Bolero 2.5 Diesel, Bolero XLS 2.5 Diesel, XYLO 2.2 TD mHawk, XUV500 2.2D, Scorpio 2.2 TD 4x4, Marazzo 1.5, Bolero Invader GLX 2.5 Diesel, Scorpio 2.2 TD, Bolero Invader GLX 2.5 Diesel 4WD, XUV500 2.2D 4x4, XYLO, Bolero 2.5 BS II, XYLO 2.5 TD mEagle, Scorpio 2.6 CRDe	9420000073, 9420000074, 0303BAM00350N, 0303BC0071N, 0303BC0010N, 71817, 24772, 0303BC0073N, 0303BAU00110N		219.00
F 002 H23 439	Oil Filter Spin-on		MAHINDRA- Scorpio 2.6 Diesel Turbo, Scorpio 2.6 Diesel Turbo 4x4	9420000073, 9420000074, 0303BAM00350N, 0303BC0071N, 0303BC0010N, 71817, 24772, 0303BC0073N, 0303BAU00110N		219.00
F 002 H23 470	Oil Filter Spin-on		HYUNDAI- i10 [IA] (P+GAS) 49 Kw (2013.09 -2020.03), i20 1.2i 16V, i10 1.2 i 16V, i10 1.1 i			260.00
F 002 H23 490	Oil Filter Spin-on		HYUNDAI- Verna 1.6i 16V, Accent 1.6 i, Accent 1.5 CRDi, Getz 1.3 i, Sonata 2.0i 16V, Sonata 2.7i, Verna 1.6i, Accent 1.5 CNG, Elantra 1.8 i, Getz 1.1 i			267.00
F 002 H23 550	Oil Filter Spin-on		SUZUKI- Baleno 1.2			167.00
F 002 H23 550	Oil Filter Spin-on		MARUTI- Dzire 1.2, Celerio 1.0 VXi Green CNG, Celerio 1.0, Alto 0.8i, A-Star 1.0i 12V, Alto 800, Ritz 1.2 Generation I, Ertiga 1.4 CNG Generation I, Swift 1.2, Alto 0.8i 12V (P) 33 Kw (2000.09 -2006.01), Swift 1.2i, Swift 1.2i Dzire, Swift 1.3i Dzire, Baleno 1.2, Eco 1.2i, Ciaz 1.4 Generation I, Ertiga 1.4 Generation I	16510M68K10, 16510M68K00, 16510M82703		167.00

### NPI Filter Application Chart

Part Number	Product Description	Image	Model Description 	Potential OE Part No	Potential Comp. Part No	MRP (₹)
F 002 H23 566	Oil Filter Spin-on		TATA MOTORS- 207 DI 3.0 Diesel (D) 48 Kw (2002.05 -2013.06), Safari 2.2, 207 DI EX (D) 48 Kw (2005.05 -2013.07)	253418130129, 254718130106, 252718130127, 253418130169, 253418130141, 254718130117, 253418130187	FLG -LF16056	425.00
F 002 H23 566	Oil Filter Spin-on		TATA MOTORS- Winger 1.9 Diesel	253418130129, 254718130106, 252718130127, 253418130169, 253418130141, 254718130117, 253418130187	FLG -LF16056	425.00
F 002 H26 361	Oil Filter Spin-on		TATA MOTORS- Sierra 1.9 Turbodiesel 4WD	252518130164		1,995.00

### Filters Cross Reference Chart

Part Number	Product Description	Potential OE Part Number	Potential Comp. Part Number
F002H24419	Air Filter Element Primary, Engine	TAE-253409130241	FLG -AF26046M
F002H24974	Air Filter Element, Engine	CHE-J96827715	
F026400365	Air Filter Element, Engine	BMW-13717800151	UFI -27A9700; GUD -AG1622; KNE -LX3598; MHL -LX3598; COR -80004661; HEG -E1077L; MN -C51001; PRF -A1553; FLT -AK3627; CMI -EAF803; WIX -WA9722; BLP -ADB112215
F002H26334	Air Filter Element, Engine	HYU-281130X200	MN -C27014
F026400344	Air Filter Element, Engine	TOY-178010C010, 170800L081, 178010C020	MFR -EL9149; KNE -LX28081; HEG -E1114L; MN -C23107; TEN -A2280; AL -ALA86991; SKR -A5903; FLT -AR3072; BBF -RS10035; ACD -PC3318E; AHK -2002259; UFI -2769100; CMI -CTY12190; FRA -CA9916; WIX -WA9644; BLP -ADT32295; ASU -03960012; PRF -A1286; JPP -FA259S
F026400035	Air Filter Element, Engine	SKO-036129620J, 036129620H	GUD -AG1363; TNO -AR036620HPM; VAO -585154; WIX -WA9545; MN -C3880; RYC -A1728; BLP -ADV182206; GWI -AG328; KSS -50014106, 4106AP; SFM -S3342A, S3435A; MQP -VFA1239; FIP -HP2242; FLT -AP1833; MYL -1123210007; ALC -MD8358; AL -ALA18018; CPF -PA7581; GUF -A1215E; FIM -PA7581; MCA -AF002; SKR -A31230; PRF -A1301; UFI -3034200; CLF -MA3105; KNE -LX2010, LX3184; FRA -CA10509; MHL -LX2010, LX3184; FBI -29965; MFR -ELP9192; CHA -CAF100748P, U748606, U748; MPC -60164; CRO -8562; ACD -PC3254E; TEN -A2271; HEG -E892L; MSF -P342; CMI -EAF702; SWA -30929965
1987429404	Air Filter Element, Engine	VWW-1K0129620G, 3C0129620A, 3C0129620B, 1K0129620F, 1K0129620D, 5C0129620, 1K0129620D	DEP -AF20125; FRA -CA9711; MFR -ELP9072; CPF -PA7444; CRO -8330; LAT -ELP9072; MFI -MAP60182; THO -2752; MHL -LX1211; MN -C35154; FIM -PA7444; SFM -S2012A; FLT -AP1392, AP1393; PRF -A1160; ALC -MD8060; BLP -ADV182204; WIX -AP1392, WA6781; KNE -LX1211; CMI -EAF501; PBR -AI5321; CLF -MA1356; TEN -A2102; UFI -3018700; HEG -E488L; GUD -AG1127; WGA -FAP6012; PUR -A14622, A18346; COO -AG1579; KSS -608AP
F026400593	Air Filter Element, Engine	MB-2820940004, A2820940004	MFR -ELP9565, 9565VN; BLP -ADU172248; FLT -AP0347; MN -C26017; HEG -E1619L; MHL -LX4784; KNE -LX4784

### Filters Cross Reference Chart

Part Number	Product Description	Potential OE Part Number	Potential Comp. Part Number
F026400149	Air Filter Element, Engine	BMW-13717582908	CPF -PA7777; MHL -LX3975, LX2787; WIX -WA9699; MFR -ELP9361; MQP -LVFA1485; PRF -A1568; CMI -EAF874; FLT -AP0285; TEN -A2492; VAO -585487; HEG -E1058L; KNE -LX3975, LX2787; FRA -CA10994; BLP -ADB112207; FIM -PA7777; GUD -AG1514; MN -C27125; MYL -3123210026; SWA -20948526; ALC -MD8570; MCA -AF118; UFI -3055700; FBI -221684, 48526
F026400389	Air Filter Element, Engine	MB-6420940204, A6420942204, A6420943004, 6420942204, 6420940404, A6420940204, 6420943004, A6420940404	KNE -LX1850S, LX18502; MN -C27006, C2720; PRF -A13272, A1327; CLF -MA3180; MHL -LX1850S, LX18502; MFR -9290V2; MSF -P202; FRA -CA106622; HEG -E1030L01, E1031L2, E627L; CPF -PA76502; BLP -ADU172202; UFI -3028200, 3046300; FLT -AP03442X; TEN -A23092; SFM -S3463A; CMI -EAF634
F002H24978	Air Filter Element, Engine	MRU-13870M53M00	
F026400222	Air Filter Element, Engine	REN-165461HC2A, 1654630P00	FLT -AP1544; UFI -3000100; CMI -CNS12222, EAF794, CNS12203; HEG -E555L; BLP -ADN12270; PRF -A364; GUD -AG1537; AL -ALA8289; MHL -LX3305; MFR -ELP9363; WIX -WA9707; NIP -N1321072; JPP -FA142S; KNE -LX3305; ALC -MD8564; MN -C2329
1987429404	Air Filter Element, Engine	SKO-1K0129620D	DEP -AF20125; FRA -CA9711; MFR -ELP9072; CPF -PA7444; CRO -8330; LAT -ELP9072; MFI -MAP60182; THO -2752; MHL -LX1211; MN -C35154; FIM -PA7444; SFM -S2012A; FLT -AP1392, AP1393; PRF -A1160; ALC -MD8060; BLP -ADV182204; WIX -AP1392, WA6781; KNE -LX1211; CMI -EAF501; PBR -AI5321; CLF -MA1356; TEN -A2102; UFI -3018700; HEG -E488L; GUD -AG1127; WGA -FAP6012; PUR -A14622, A18346; COO -AG1579; KSS -608AP
F002H26396	Air Filter Element, Engine	HYU-28113A0100	
F026400182	Air Filter Element, Engine	VWW-7L0129620A, 7P0129620A	FLT -AP0051; PRF -A1550; CLF -MA3115; HEG -E1056L; FRA -CA11425; KNE -LAO437, LX20241, LX2024, LX793; UFI -30A2500; TPR -112954; MFR -ELP9098; MN -C39002; JPG -1618601500; CPF -PA7760; LAT -503; MHL -LAO437, LX20241, LX2024, LX793; MYL -1121290044
F026400425	Air Filter Element, Engine	AUD-8W0133843C	KNE -LX4406; FLT -AK3761; PRF -A1819; GUF -A165E; MHL -LX4406; MN -C17013; GUD -AG1911; HEG -E1451L
F026400422	Air Filter Element, Engine	AUD-8W0133843A	GUF -A169E; WIX -WA9829; GUD -AG1904; PRF -A1818; KNE -LX4407; MN -C17011; UFI -27G3300; MHL -LX4407; FLT -AK376; HEG -E1453L
F002H23585	Air Filter Element, Engine	MHI-0313AAC04390N	

### Filters Cross Reference Chart

Part Number	Product Description	Potential OE Part Number	Potential Comp. Part Number
F026400289	Air Filter Element, Engine	AUD-L4GD133843A, 4G0133843H, 4G0133843K, 4GD133843A	HEG -E1055L; MN -C15010; FIM -FL9212; FRA -CA11424; CLF -MA3162; UFI -27A5400; CMI -EAF808; CPF -FL9212; WIX -WA9732; GUD -AG1557; KNE -LX26072; FLT -AR3716; PRF -A1549; BLP -ADV182227
F002H23584	Air Filter Element, Engine	MHI-0313AAM01480N, 0313AC2261N	
F002H26323	Air Filter Element, Engine	TAE-279109130112, 279709130103, 279009130122	
F026400374	Air Filter Element, Engine	BMW-13718511668	PRF -A1538; HEG -E1082L; MFR -ELP9397; UFI -3054000; GUD -AG1562; MN -C24024; SFM -S5403A; CMI -EAF813; FIM -PA7749; TEN -A2462; WIX -WA9753; CPF -PA7749; FLT -AP0262; FRA -CA11360; MHL -LX20774
F026400674	Air Filter Element, Engine	LEX-1780177050	MHL -LX4529; WIX -WA9879, WA10807; BLP -ADT322131; HEB -J1322132; MN -C27063; KNE -LX4529; PRF -A3067; FLT -AP1784; GUF -A583J
1457433781	Air Filter Element, Engine	LRG-ESR4103	MNC -C2874; SFM -S3068A; AMK -HA8637; COO -AG1204; PUR -A17943; FRA -CA5657; MPC -60506; PRF -A389; DEP -AF493, AF0493; NIP -J1324035; CMI -EAF017; RYC -A1462; CRO -9295; LAT -ELP3837; MFR -ELP3837; PBR -AI5183; UFI -3006800; GUD -AG946; FIM -PA7240; FLT -AP1871; MN -C2874; MHL -LX719, LX952; WFF -WCA9295; HEB -J1324035; WIX -WA6521; CLF -MA1104; KNE -LX719, LX952; CHA -AP148, U698; ALC -MD9430; SOP -LX719; HAF -HAF311; UNP -GFE2354, GFE2254; ACD -PC2358E; THO -2637; HEG -E637L; TEN -A147; LUB -AP148
F026400391	Air Filter Element, Engine	SKO-6R0129620A	MN -C15008; HEG -E1017L; MFR -EL9318; WIX -WA9645; FRA -CA10822; LUC -LFAF294; CLF -MA3138; MYL -1123210008; GUD -AG1384; PRF -A1344; CMI -EAF764; MHL -LX2831; DEP -PC3323E; AL -ALA8910; FLT -AK3702; BLP -ADV182212; MSF -R464; UFI -2762100
F002H23427	Air Filter Element, Engine	MRU-13780M68K00, 13780M75J00	

### Filters Cross Reference Chart

Part Number	Product Description	Potential OE Part Number	Potential Comp. Part Number
F026400342	Air Filter Element, Engine	SKO-04E129620	HEG -E1105L; CPF -PA7776; CMI -EAF848; PRF -A1567; TEN -A2491; MFR -ELP9392, 9392M; SWA -30104798; SFM -S3549A, S3549A1; GUF -A1342E; FRA -CA11503; FLT -AP0621, 0621AN; CHA -CAF101067P; ALC -MD8722; MCA -AF038; KNE -LX3525, LX3807; CLF -MA3211; MN -C27009; BLP -ADV182281, ADV182221; SKR -A31940; GUD -AG1542; MPC -60839; MHL -LX3525, LX3807; TEF -ARL6074; WIX -WA9766; MQP -LVFA1502; MYL -1123210031; UFI -3054900
F002H24419	Air Filter Element, Engine	TAE-253409130241	FLG -AF26046M
F026400558	Air Filter Element, Engine	HYU-28113C8000	UFI -30A2100; BLP -ADG022148; FRA -AP1972; FLT -AP1972; AL -ALA1921; CHA -CAF101266P; WIX -WA9801; NIP -N1320550; ALC -MD8812; PRF -A1796; CMI -EAF938; AMK -HA742; SOG -A1796; GUD -AG1752; HEG -E1355L; JPP -FAH33S; KNE -LX4238; MSF -P753; MN -C25002; EOR -1667451580; MFR -ELP9587; SFM -S3A21A; MHL -LX4238
F026400182	Air Filter Element, Engine	POR-95811013010, 95511013110	FLT -AP0051; PRF -A1550; CLF -MA3115; HEG -E1056L; FRA -CA11425; KNE -LAO437, LX20241, LX2024, LX793; UFI -30A2500; TPR -112954; MFR -ELP9098; MN -C39002; JPG -1618601500; CPF -PA7760; LAT -503; MHL -LAO437, LX20241, LX2024, LX793; MYL -1121290044
1987429401	Air Filter Element, Engine	MB-A2710940204, 2710940204	ALC -MD8118; CLF -MA3016; FIP -HP2612; GUD -AG1147; MQP -VFA1087; FLT -AK2181; PBR -AI3738; CMI -EAF512; SWA -10939751; FBI -39751; VAO -585649; COO -AG1604; WYT -WA25414; MCA -AF127; TEN -A2091; CHA -AF5983, V464, CAF100464C, V464606; CPF -FL9052; FRA -CA9680; TNO -AR9680; LAT -EL9113; MAR -71761679; ACD -PC2041E; CRO -8303; BLP -ADU172216; FIM -FL9052; MHL -LX3972, LX1277; KNE -LX3972, LX1277; SKR -A26320; MN -C14114; RYC -A1602; MYL -0123210006; WIX -WA9443, 49214; LUB -AF5983; KSS -50013986, 986AR; PRF -A1155; HEG -E472L; SFM -S1902A; UFI -2748600; MPC -60856; MFR -EL9113
F002H24976	Air Filter Element, Engine	HON-17220RNYE01	
F002H23595	Air Filter Element, Engine	HYU-281130X000	



### Filters Cross Reference Chart

Part Number	Product Description	Potential OE Part Number	Potential Comp. Part Number
F026400388	Air Filter Element, Engine	MB-6420942804, A6420942104, 6420940304, 6420940404, A6420942804, 6420942104, A6420940304, A6420940404	ALC -MD8406; PRF -A13272, A1327; MSF -P102; MN -C25004, C2520; KSS -50013999, 999AP; CLF -MA3180; GUD -AG1425; HEG -E1031L2, E1029L01, E627L; FRA -CA106622; WIX -WA9504; MFR -9290V1, JLP9290; BLP -ADU172202; CPF -PA76502; KNE -LX1850S, LX18501; MQP -VFA1203; MYL -0143210003S; FLT -AP03442X, 03422XN; SFM -S3282A, S3462A; TEN -A23092; MHL -LX1850S, LX18501; UFI -3046200, 3028200; CMI -EAF634
F002H24967	Air Filter Element, Engine	HYU-281131V100	
F002H60012	Air Filter Element, Engine	MHI-0313AAM02031N, 0313AC0280N	
1457433091	Air Filter Element, Engine	ROL-13717505007	WIX -WA6786; HEG -E608L; CLF -MA1332; MHL -LX1481, LX778, LX1216; FRA -CA9634; FLT -AP0322; GUD -AG1447; PRF -A1888; MN -C301531; KNE -LX1481, LX778, LX1216; FIM -PA7419; PUR -A25558; CMI -EAF486; MFR -ELP9121
F026400391	Air Filter Element, Engine	VWW-6RF129620, 6R0129620A, 6R0129607C	MN -C15008; HEG -E1017L; MFR -EL9318; WIX -WA9645; FRA -CA10822; LUC -LFAF294; CLF -MA3138; MYL -1123210008; GUD -AG1384; PRF -A1344; CMI -EAF764; MHL -LX2831; DEP -PC3323E; AL -ALA8910; FLT -AK3702; BLP -ADV182212; MSF -R464; UFI -2762100
F026400699	Air Filter Element, Engine	JAG-0613872A, T4A6123, GX739601AA	MQP -LVFA1654; HEG -E1667L; ALC -MD8986; KNE -LX43351; BLP -ADJ132233; MHL -LX43351; GUF -A1408E; MN -C26041; WIX -WA10565; AL -ALA181082; FLT -AP1937; AHK -200LL23
F026400415	Air Filter Element, Engine	LEX-1780138010, 1780138011, 178010V020, 178010V040	HSS -AF1414; AHK -20022001; MHL -LX2992; AMK -TA1697; KNE -LX2992; BLP -ADT32297; PRF -A3076; MFR -ELP9542; FLT -AP1704; CPF -PA7956; CHA -AF3938; JPP -FA2001S; TEN -A2735; WIX -WA9900; ASU -03964012; CMI -EAF784; NIP -J1322104; GUD -AG1624; PUR -A25786; FRA -CA10677
F026400180	Air Filter Element, Engine	SKO-1K0129620	GUD -AG1153; FIM -PA7542; MN -C36188; WIX -WA9516; SFM -S3303A; FRA -CA10328; PBR -AI5441; MHL -LX1500; PRF -A1260; CHA -U883606; ALC -MD8402; UFI -3030300; ACD -PC3087E; HEG -E701L; FLT -AP0044; MFR -ELP9280; TEN -A2226
F026400433	Air Filter Element, Engine	CIT-1638027680, 9800097580	BLP -ADP152215; MFR -ELP9418; WIX -WA9794; MN -C29110; CPF -PA7828; UFI -3071700; FLT -AP0909; MSF -ELP9418; PRF -A1725; FIM -PA7828; KNE -LX3754; HEG -E1160L; MHL -LX3754

### Filters Cross Reference Chart

Part Number	Product Description	Potential OE Part Number	Potential Comp. Part Number
1457433091	Air Filter Element, Engine	BMW-13710151548, 13717505007, 13717526008	WIX -WA6786; HEG -E608L; CLF -MA1332; MHL -LX1481, LX778, LX1216; FRA -CA9634; FLT -AP0322; GUD -AG1447; PRF -A1888; MN -C301531; KNE -LX1481, LX778, LX1216; FIM -PA7419; PUR -A25558; CMI -EAF486; MFR -ELP9121
F026400273	Air Filter Element, Engine	HYU-2811302750, 2811305701, 2811305700	HEB -J1320529; JPP -FAH18S, J1320519, FAH11S; NIP -J1320519; WIX -WA9714, WA9681; AMK -HA725, HA678; ALC -MD8558, MD8166; BLP -ADG02134, ADG022103, ADG02276, ADG02278; LAT -556, 589; CHA -CAF100998P; ASU -Y00205; CMI -CHY12264; PRF -A1418; MN -C28005, C2742; MED -18339; CPF -PA7694; MHL -LX1896, LX1981; CLF -MA3178, MA3245; MFR -ELP9305, ELP9398; FIM -PA7694; HEG -E1212L, E1193L; SFM -S3307A; AHK -200H011, 200HH18; VAO -585318; FLT -AP1074, AP1076; KNE -LX1896, LX1981; MSF -P717, P307; MYL -37123210020, MAF0536, 37123210033; FRA -CA10912; UFI -3030700, 3062000; HFR -18339; GUD -AG1389
1987429404	Air Filter Element, Engine	AUD-3C0129620A, 3C0129620B, 5C0129620, 1K0129620D	DEP -AF20125; FRA -CA9711; MFR -ELP9072; CPF -PA7444; CRO -8330; LAT -ELP9072; MFI -MAP60182; THO -2752; MHL -LX1211; MN -C35154; FIM -PA7444; SFM -S2012A; FLT -AP1392, AP1393; PRF -A1160; ALC -MD8060; BLP -ADV182204; WIX -AP1392, WA6781; KNE -LX1211; CMI -EAF501; PBR -AI5321; CLF -MA1356; TEN -A2102; UFI -3018700; HEG -E488L; GUD -AG1127; WGA -FAP6012; PUR -A14622, A18346; COO -AG1579; KSS -608AP
1457433065	Air Filter Element, Engine	MB-6110940004, 6110940104, 6110940304, A6110940004, A6110940104, A6130940004, 6130940004, A6110940304	LAT -ELP9083; SOP -LX752; TEN -A2045; GUD -AG1039; HEG -E397L, E397L01; CRO -8259; COO -AG1566; UFI -3014800; DEP -AF20103; MN -C38145; FIM -PA7339; MHL -LX752, LX727; MFR -ELP9083; MFI -MAP60074; FRA -CA9041; PUR -A28281; WIX -WA6705; THO -2672; CLF -MA1378; FLT -AP1189; PBR -AI5307; AL -ALA88368; ACD -PC2521E; KSS -435AP; SFM -S5402A; PRF -A1125; KNE -LX752; ALC -MD9628; MSF -P405; CMI -EAF417; CHA -U787
F002H23418	Air Filter Element, Engine	TOY-178010C030, 178010C010, 1780100010	

**Filters Cross Reference Chart**

Part Number	Product Description	Potential OE Part Number	Potential Comp. Part Number
F026400346	Air Filter Element, Engine	FIA-51817708, 51925027, 51837082, 51901760, 51920958, 51873070, 51897086	MAR -71760240, 71760239; TEN -A2394; AL -ALA8242; MSF -P606; MQP -LVFA1460, LVFA1528; SFM -S3478A, S3477A; MED -18505; FLT -AP0782, AP0781; BBF -PA10013; MYL -2123210023; FIM -PA7701; GUD -AG1739; HEG -E1124L; FIP -HP2285, HP2297; CLF -MA3071, MA3068; UFI -3047700, 3047800; CMI -EAF788, EAF763; KNE -LX4460, LX3465; PRF -A1455; FRA -CA11188; WIX -WA9731, WA9666; GUF -A1304EF; ACD -PC3338E, PC3350E; CPF -PA7701; MFI -K7006; SWA -70939839; MFR -ELP9345, ELP9210; ALC -MD8524, MD8594; FBI -39839; VAO -585407; BLP -ADA102248, ADL142208, ADZ92230; MN -C35006, C360061, C36006; MHL -LX4460, LX3465
1457433043	Air Filter Element, Engine	MB-A1110940304, 1110940304	FIM -PA7381; SOP -LX992; COO -AG1627; MN -C52107; CHA -U717; MHL -LX992; ACD -PC2558E; UFI -3020100; PUR -A18348; CMI -EAF403; GUD -AG1042; HEG -E373L; KNE -LX992; FLT -AP0352; TEN -A2062; MFR -ELP3960; CLF -MA1342; DEP -AF20100; ALC -MD8002; PBR -AI5352; PRF -A1132; THO -2692; LAT -ELP3960; WIX -WA6680; FRA -CA9423; CRO -8273; SFM -S2602A
F026400360	Air Filter Element, Engine	BMW-13718513944, 13717619267	KNE -LX4060, LX4059; TNO -AR22017PMS; GUF -A1374E, A1374EF; TEF -ART6701; JPP -FA0105JM; MED -18694, 18639; GUD -AG1729, AG1685; FLT -AP0264; MHL -LX4060, LX4059; CLF -MA3257; ALC -MD8810, MD8784; TEN -A2548, A2544; KSS -50014742, 4742AP, 4708AP, 50014708; AHK -FA0105JM; UFI -3062200, 3062100; SFM -S3621A, S3622A; CMI -EAF909, EAF884; WIX -WA9792, WA9791; MFR -ELP9412, ELP9488; FRA -CA11860, CA11888; MYL -3123210039; MN -C22018, C22017; CPF -PA7818, PA7822; AL -ALA18025; FIM -PA7818, PA7822; PRF -A1715, A1719; COO -PA7818; MQP -LVFA1568, LVFA1567; BLP -ADB112221, ADB112219; HEG -E1280L, E526L; FBI -109203, 109202
F026400692	Air Filter Element, Engine	BMW-13718580429, 8580429	BLP -ADBP220040; CMI -EAF1048; MSF -P813A; KNE -LX39852; PRF -A3048; HEG -E1777L; MFR -ELP9605; FLT -AP0266; AL -ALA18100; MHL -LX39852
1457433286	Air Filter Element, Engine	FIA-7688498, 71754227, 71736145	FIM -PA7182; PRF -A270; KNE -LX689; WIX -WA6269; CMI -EAF229; CLF -MA1047; FRA -CA5677; MN -C2981; COO -AG1299; FLT -AP093; MHL -LX495; CHA -U611; UFI -3005300; MFR -ELP3656; CRO -8050

**Filters Cross Reference Chart**

Part Number	Product Description	Potential OE Part Number	Potential Comp. Part Number
1457433593	Air Filter Element, Engine		MN -C2244, C2237; UNP -GFE2568; KSS -4021AP, 50014021; MOT -EFA601; MAR -71758669; SWA -50927291; SKR -A8597; TNO -AR2080PM; AHK -2003350; MQP -VFA1007; PUR -A28353, A29212; LAT -ELP9081; MHL -LX1046, LX1268, LX2585; NIP -J1323052; AL -ALA8470; BLP -ADG02249, ADM52247; AMK -MA5634; MED -18238, 18086; GUD -AG1203; DEP -AF20113; HFR -8400086; FLT -AP192; PRF -A1145; CHA -CAF100810P, U810; PBR -AI5276, AL5287, AI5287; CMI -EAF418; CLF -MA1318; MSF -P168; KNE -LX1046, LX1268, LX2585; HEG -E890L, E414L; VAO -585083; CPF -PA7398, PA7386; FIP -HP2230; WIX -42799, WA6706, WA6754; HEB -J1323049; MYL -7121140000, 3123210018; SFM -S0802A; UFI -3016800; JPP -FA350S, FA350, JFA350; MFR -ELP9081, ELP9118; WYT -WA50203; TEN -A2080; FRA -CA9494, CA9435; FIM -PA7398; ALC -MD8234, MD8020; FBI -27291; GWI -AG537; COO -AG1481, AG1535; MPC -60621
F026400456	Air Filter Element, Engine	LEX-1780131170	PRF -A1305; NIP -N1322119; MHL -LX3527; ND -CPG03; KNE -LX3527; TEN -A2285; AMK -TA1269; UFI -3045300; MQP -LVFA1556; AL -ALA82881; BLP -ADT322117; MN -C24150; GUD -AG1789; MFR -ELP9450
F026400017	Air Filter Element, Engine	TOY-178010D010, 1780122020, SU00300319, 178010D011, SU0030031900, 178010D020	WGA -JFA0283; FLT -AP1423; GUD -AG1098; PRF -A1136; MFR -ELP3983; FIM -PA7438; VAE -VA171; COO -AG1596; HEG -E640L01, E640L; UFI -3028900; CMI -CTY12095; AMK -TA1683; BBF -PA4180; CHA -AF3595; ASU -03963802; CRO -4048276ALF; PNN -PZA433; MHL -LX1286; BLP -ADT32276; SKR -A1180; AL -ALA11229; TEF -ARL2202; WIX -WA6785; FRA -CA9482; HSS -AF1161; KNE -LX1286; NIP -J1322083; MN -C2620; TEN -A2066
F026400713	Air Filter Element, Engine	BMW-13718577171	MSF -P868A; KNE -LX4625; MN -C28038; PRF -A1868; MHL -LX4625
F026400343	Air Filter Element, Engine	DAC-8660003761, 165469843R, 165467674R	MN -C27029, C27030; EOR -1616267580; WIX -WA9770; CPF -PA7778; UFI -3054700; FLT -AP1335; MFR -ELP9379; AL -ALA83661; CHA -CAF101062P; LUC -LFAF131; MCA -ELP9379; KNE -LX3542, LAK923; FRA -CA11654; MSF -P528; SFM -S3547A; HEG -E1440L; LAT -299; BLP -ADR162210; GUD -AG1712; PRF -A1569; CMI -EAF853; FIM -PA7778; MHL -LX3542, LAK923

**Filters Cross Reference Chart**

Part Number	Product Description	Potential OE Part Number	Potential Comp. Part Number
F026400379	Air Filter Element, Engine	MB-6510940204, A6510940204	HEG -E1061L; MN -C22020; FLT -AP0345; CMI -EAF805; UFI -3059500; FRA -CA11304; GUD -AG1561; PRF -A1536; WIX -WA9746; MHL -LX3471
F026400650	Air Filter Element, Engine	AUD-8K0133843L	FLT -AK3718; UFI -27H0600; AL -ALA8929; ALC -MD5406; KNE -LX4249; MHL -LX4249; MN -C17009; PRF -A1623; MQP -LVFA1597; BLP -ADV182260; CMI -EAF1002; WIX -WA9842; HEG -E1159L
F002H23596	Air Filter Element, Engine	HYU-281131J000, 28113C7000	
F026400513	Air Filter Element, Engine		PRF -A1289; TEF -ART6702; KNE -LX15912, LX15919; UFI -3034100; MN -C35177; AL -ALA88432; HEG -E1000L; GUD -AG1424; CLF -MA3175; MHL -LX15912, LX15919; FLT -AP1656; RYC -A1772; SFM -S3341A; WIX -WA9572; MFR -ELP9309
1457433101	Air Filter Element, Engine	BMW-13717521037, 1371752103701, 13717521023	ASU -ZD1829; WIX -WA9607; MQP -VFA1222; HEG -E728L; MYL -MAF0422, 3123210008; FLT -AP0323; MN -C31149; ACD -PC3321E; MHL -LX982; CMI -EAF675; ALC -MD8514; MFR -ELP9155; PRF -A1838; GUD -AG1448; KNE -LX982; MSF -P445; KSS -4090AP, 50014090; TPR -501307
9951030131	Air Filter Element, Engine	MRU-13780M797D0, 13780M797D1, 13780M79201, 13780M79250	
F026400182	Air Filter Element, Engine	AUD-7L0129620A, 7P0129620A	FLT -AP0051; PRF -A1550; CLF -MA3115; HEG -E1056L; FRA -CA11425; KNE -LAO437, LX20241, LX2024, LX793; UFI -30A2500; TPR -112954; MFR -ELP9098; MN -C39002; JPG -1618601500; CPF -PA7760; LAT -503; MHL -LAO437, LX20241, LX2024, LX793; MYL -1121290044
F026400738	Air Filter Element, Engine	REN-165463205R	MSF -P352A; MN -C24104; UFI -3049100; MFR -ELP9523
1457433094	Air Filter Element, Engine	BMW-7521038, 1371752103301, 7521033, 13717521033, 13717521038	ACD -PC3101E; WIX -WA9492; SWA -20927036; PRF -A1188, A1187; MQP -VFA1164; HEG -E720L; AL -ALA85922; GUD -AG1376; FLT -AP0324; KSS -667AP, 50013677, 677AP; BLP -ADB112224; MFR -ELP9182; MCA -AF121; CHA -AF3965, U773606, CAF100773P, U773; TIV -0814048; TEN -A2145; MHL -LX944; FRA -AF3965, CA10022; THO -27681; CRO -8375; FBI -27036; MAR -154066260300; CPF -AG1648, PA7491; KGR -120778; CLF -MA3040; SFM -S3251A; MPC -60616; VAO -585281; PBR -AI5400; UFI -3025100; MYL -3123210003; MN -C30139; COO -AG1648; KNE -LX944, LX1147; CMI -EAF614; QHZ -QFA0447

**Filters Cross Reference Chart**

Part Number	Product Description	Potential OE Part Number	Potential Comp. Part Number
1457433588	Air Filter Element, Engine	LRG-PHE100500L, LR007478	PBR -AI3708; MFR -EL3816; UNP -GFE2421; DEP -AF20068; FIM -ANF1277, FL6994; KSS -913AR; RYC -A1540; ACD -PC2070E; COO -AG1411; FRA -CA8934; HEG -E377L; WGA -WR362; MFI -MAP60078, MAU60078; MN -C151051; CRO -8189; TEN -A295; PUR -A38255; MPC -60603; PRF -A1052; GUD -AG1017; WIX -WA6573; FLT -AK362; UFI -2735300; LAT -EL3816; MHL -LX823; KNE -LX823; CMI -EAF078; SFM -S5920A; CLF -MA1128; ALC -MD9504
F002H23586	Air Filter Element, Engine	MHI-0313AAM00521N	
1457433589	Air Filter Element, Engine	BMW-13712247444	PRF -A1078; CLF -MA3012; MFI -MAU60095; MHL -LX818; CMI -EAF079; DEP -AF20032; KSS -914AR; ACD -PC2075E; RYC -A1539; UFI -2738400; WIX -WA6574; HEG -E376L; CHA -V460; FLT -AK3621; FIM -FL9006; MN -C151431; FRA -CA8985; CPF -FL9006; TEN -A629; ALC -MD9516; LAT -EL3954; BLP -ADB112201; KNE -LX818; MFR -EL3954; COO -AG1509; SFM -S9260A; PUR -A28302; GUD -AG1016
F026400226	Air Filter Element, Engine	LEX-1780151020	JPP -FA264S; MHL -LX5055; NIP -N1322110; UFI -3078500; BLP -ADT322105; FLT -AP1436; PRF -A1521; HEB -J1322075; GUD -AG1887; HEG -E1763L; KNE -LX5055; FRA -CA11270; AMK -TA1693
F026400463	Air Filter Element, Engine	BMW-13717542545	FLT -AP0283; GUD -AG1342; WIX -WA9611; MHL -LX1250; MN -C29132; PRF -A1709; MFR -ELP9349; SFM -S3455A; HEG -E852L; FRA -CA10324; KNE -LX1250; ACD -PC3097E; UFI -3045500; ALC -MD8408; CMI -EAF617
F026400755	Air Filter Element, Engine	POR-99111013000	HEG -E1722L
F026400677	Air Filter Element, Engine	AUD-8W0133843	MQP -LVFA1609; KNE -LX4410; MHL -LX4410; UFI -27G3100; FLT -AK3762; GUF -A167E; MN -C17010; MFR -EL9508; ALC -MD5384; PRF -A1942; FBI -102972; HEG -E1452L; BLP -ADV182273; GUD -AG1910
F002H26329	Air Filter Element, Engine	MRU-13780M83B00	
F026400155	Air Filter Element, Engine	MB-1130940004, A1130940004	MHL -LX2877; SWA -10948463; GUD -AG1139; CHA -U784, U784606; BLP -ADU172213; ACD -PC2508E; KNE -LX2877; FBI -48463; PRF -A1877; MYL -0123210004; HEG -E455L02; CMI -EAF682; WIX -46799; MN -C3689
F002H26395	Air Filter Element, Engine	TAE-570709130114	

### Filters Cross Reference Chart

Part Number	Product Description	Potential OE Part Number	Potential Comp. Part Number
1457433698	Air Filter Element, Engine		PBR -AI5019; HEG -E161L, E161L01; KSS -238AP; UFI -3002900; FIM -PA7090; WIX -WA9405; MHL -LX422; PRF -A325; KNE -LX422; FRA -CA5107; GUD -AG871; FLT -AP0631; MN -C26151; CMI -EAF489; PUR -A47039; TEN -A327
1457433714	Air Filter Element, Engine	VWW-1J0129620, 1J0129620	COO -AG1281; WFF -WCA8116; MPC -60034; CHA -U562; PRF -A379; CLF -MA1061; DEP -AF0273; CMI -EAF035; FIM -PA7216; MFI -MAP6976; PBR -AI5172; ALC -MD9422; CRO -8116; MHL -LX684; ACD -PC2515E; BAC -PA4111; MFR -ELP3781, ELP3713; KSS -503AP; LAT -ELP3713; UFI -3007700; FRA -CA8602, CA5827; SFM -S3077A; AL -ALA8428; WIX -42472, WA6333; GUD -AG920; RYC -A1432; THO -2553; MN -C37153; TEN -A146; PUR -A27766, A35267; HEG -E301L; KNE -LX684; LUB -AF7935, AP20; FLT -AP1491; CPF -PA7216
F026400050	Air Filter Element, Engine	MBM-13717534825	MCA -AF124, AF388; PRF -A1273; HEG -E851L; CLF -MA3109, MA3148; PBR -AI5456; TEN -A2248; FLT -AP0588, AP0589; ALC -MD8448; ACD -PC3316E; MQP -VFA1128; MHL -LX2843, LX1969, LX2038; MN -C50822, C5082; MAR -71760224, 71760460; UFI -3034500, 3040000; KSS -4452AP; MYL -1123210013, 1123210005; KNE -LX2843, LX1969, LX2038; SWA -62934399; MSF -P566A; CRO -8536; GUD -AG1420; VAO -585247, 585205; CPF -PA7561; SFM -S3345A, S3400A; FIP -HP2244; MFI -K7004; BLP -ADB112205; CMI -EAF693, EAF709; FBI -34399; COO -AG1766; WIX -WA9596, WA9748; MFR -ELP9232, ELP9233; FIM -PA7561; UNP -GFE4206; FRA -CA10418; TNO -AR10418PMS
F002H24977	Air Filter Element, Engine	HYU-281134N000	
F002H24980	Air Filter Element, Engine	TAE-570309130108	
F002H24975	Air Filter Element, Engine	HYU-28113B4400	
F026400147	Air Filter Element, Engine	BMW-13713428558, 13713449003, 1371342855801	BLP -ADB112245; FLT -AP0284; VAO -585313; MN -C68001; PRF -A1492; HEG -E1018L; GUD -AG1483; KNE -LX2067; KSS -50014472, 4472AP; ALC -MD8482; MPC -60608; SFM -S3395A; MYL -3123210023; MHL -LX2067; FBI -101443; AL -ALA8880; WIX -WA9658; CMI -EAF776; FRA -CA11210; CLF -MA3156; MFR -ELP9329; ACD -PC3327E; MAR -71760468; UFI -3039500; CPF -PA7716; MQP -LVFA1458

### Filters Cross Reference Chart

Part Number	Product Description	Potential OE Part Number	Potential Comp. Part Number
1457433953	Air Filter Element, Engine	MRU-1378060G00	FLT -AP176; THO -2590; COO -AG1396; VIC -A957; CLF -MA1198; WIX -WA6363; MFR -ELP3795; PRF -A1364; AMK -SA9077; AL -ALA1502; HEG -E790L; MNC -C1924; FRA -CA5687; FIM -PA7183; PUR -A25220; WFF -WA941; UFI -30A5000; RYC -A1338; NIP -J1328019; CMI -CSZ12957; MHL -LX861; MN -C1924
F026400287	Air Filter Element, Engine	AUD-5Q0129620B, 5Q0129620C, 5Q0129620D	MHL -LX3502, LX3503; WGA -FAP9065; TPR -114420; BLP -ADV182216; SFM -S3532A; WIX -WA9759; MN -C30005, C30004; MSF -P536; TEF -ARL6077; CMI -EAF818; ALC -MD8656; MGA -FA3406; HEG -E1090L; PRF -A1565, A1718; CLF -MA3184; KNE -LX3502, LX3503; FLT -AP1395, AP1396; FRA -CA11499; GUD -AG1573; CHA -CAF101064P; MFR -ELP9376, ELP9375; LAT -583; UFI -3053200; KSS -4529AP, 50014529; MYL -MAF0191, 1123210030; EOR -1612889280
F026400026	Air Filter Element, Engine		CHA -CAF100932P, U932606; KNE -LX12891; SFM -S3366A; FBI -100377; MPC -60117; MN -C23129; PRF -A1290; UFI -3036600; ACD -PC3230E; TNO -AR10499PMS; FLT -AP1655; MHL -LX12891; GUD -AG1662; MFR -ELP9386; CPF -PA7575; FIM -PA7575; AL -ALA88442; MYL -5123210001; BLP -ADF122218; TEN -A2267; WIX -WA9505; MQP -VFA1204; CMI -EAF616; ALC -MD8260; HEG -E512L; MFI -MAP60186; FRA -CA10499; CLF -MA3234
F026400342	Air Filter Element, Engine	VWW-04E129620	HEG -E1105L; CPF -PA7776; CMI -EAF848; PRF -A1567; TEN -A2491; MFR -ELP9392, 9392M; SWA -30104798; SFM -S3549A, S3549A1; GUF -A1342E; FRA -CA11503; FLT -AP0621, 0621AN; CHA -CAF101067P; ALC -MD8722; MCA -AF038; KNE -LX3525, LX3807; CLF -MA3211; MN -C27009; BLP -ADV182281, ADV182221; SKR -A31940; GUD -AG1542; MPC -60839; MHL -LX3525, LX3807; TEF -ARL6074; WIX -WA9766; MQP -LVFA1502; MYL -1123210031; UFI -3054900



### Filters Cross Reference Chart

Part Number	Product Description	Potential OE Part Number	Potential Comp. Part Number
1457433714	Air Filter Element, Engine	AUD-1J0129620	COO -AG1281; WFF -WCA8116; MPC -60034; CHA -U562; PRF -A379; CLF -MA1061; DEP -AF0273; CMI -EAF035; FIM -PA7216; MFI -MAP6976; PBR -AI5172; ALC -MD9422; CRO -8116; MHL -LX684; ACD -PC2515E; BAC -PA4111; MFR -ELP3781, ELP3713; KSS -503AP; LAT -ELP3713; UFI -3007700; FRA -CA8602, CA5827; SFM -S3077A; AL -ALA8428; WIX -42472, WA6333; GUD -AG920; RYC -A1432; THO -2553; MN -C37153; TEN -A146; PUR -A27766, A35267; HEG -E301L; KNE -LX684; LUB -AF7935, AP20; FLT -AP1491; CPF -PA7216
F026400222	Air Filter Element, Engine	NIS-16546JG30A, 165461HC2A, 1654673C10, 1654673C00, AY120NS022, 1654673C01, 165463J41A, 1654630P00, 1654617B00, 1654673C11, 165463J410	FLT -AP1544; UFI -3000100; CMI -CNS12222, EAF794, CNS12203; HEG -E555L; BLP -ADN12270; PRF -A364; GUD -AG1537; AL -ALA8289; MHL -LX3305; MFR -ELP9363; WIX -WA9707; NIP -N1321072; JPP -FA142S; KNE -LX3305; ALC -MD8564; MN -C2329
F026400287	Air Filter Element, Engine	VWW-5QM129620, 5Q0129620B, 5Q0129620C, 5Q0129620D	MHL -LX3502, LX3503; WGA -FAP9065; TPR -114420; BLP -ADV182216; SFM -S3532A; WIX -WA9759; MN -C30005, C30004; MSF -P536; TEF -ARL6077; CMI -EAF818; ALC -MD8656; MGA -FA3406; HEG -E1090L; PRF -A1565, A1718; CLF -MA3184; KNE -LX3502, LX3503; FLT -AP1395, AP1396; FRA -CA11499; GUD -AG1573; CHA -CAF101064P; MFR -ELP9376, ELP9375; LAT -583; UFI -3053200; KSS -4529AP, 50014529; MYL -MAF0191, 1123210030; EOR -1612889280
F026400423	Air Filter Element, Engine	LRG-GJ329601AA, LR071942	MN -C28022; UFI -30A6300; BLP -ADJ132235; FLT -AP1939; MYL -53123210004; MHL -LX4392; ALC -MD8872; CMI -EAF958; PRF -A1810; KNE -LX4392; GUF -A1398E; FRA -CA12122; MQP -LVFA1642; HEG -E1446L
F026400270	Air Filter Element, Engine	BMW-13718605164	KNE -LX3320; GUF -A1399E; HEG -E1345L; TEN -A2587; CPF -PA7415; MN -C27045; FRA -CA12142; AL -ALA18051; FLT -AP0328; GUD -AG1803; MQP -LVFA1623; PRF -A1811, PA3790; MHL -LX3320
F026400036	Air Filter Element, Engine	FIA-6000633297, K6000633297, 55192012	PRF -A1221; TEN -A2181; HEG -E1020L; MN -C2859; FLT -AP0222; WIX -WA9556; KNE -LX1827; CMI -EAF587; GUD -AG1422; UFI -3030100; MFR -ELP9169; FIM -PA7484; FRA -CA9942; CPF -PA7484; BLP -ADL142203

### Filters Cross Reference Chart

Part Number	Product Description	Potential OE Part Number	Potential Comp. Part Number
F026400480	Air Filter Element, Engine	MB-2740940004, A2740940004	RYC -A1929; GUD -AG1651; FRA -CA11761; MFR -EL9461; FIM -FL6998; MHL -LX3775; NIP -N1321093; FLT -AK2187; PRF -A1622; UFI -27A9200; KNE -LX3775; WIX -WA9785; SFM -S7A92A; VAO -728704; MN -C14006; CPF -FL6998; HEG -E1145L; MPC -60781; CMI -EAF913; AMK -NA2634
F002H20378	Air Filter Element, Engine	MRU-13780M79F00	
F026400219	Air Filter Element, Engine	MBM-13717568728	GWI -AG293; BLP -ADP152204; GUF -A1201E; ACD -PC3353E; CMI -EAF793; TEF -ARL5057; FRA -CA11096; PRF -A1274, A1404; FLT -AP1964; MQP -LVFA1429; TEN -A2349; MN -C36003; GUD -AG1484; MFR -ELP9126; KSS -4665AP; MYL -11123210027; RYC -A1809; MSF -P588; WIX -49728, WA9689; MHL -LX4215, LX2033, LX3699; CLF -MA3182; KNE -LX4215, LX2033, LX3699; UFI -3046700; FIM -PA7682; HEG -E1086L; SFM -S3467A, S3467A1; TNO -AR10416PMHE; ALC -MD8718; AL -ALA8879
1987429166	Air Filter Element, Engine	CHE-96314494, J990435L0	TEN -A535; GUD -AG997; MN -C2119; PRF -A1060; WIX -WA6253; AL -ALA1903; BLP -ADG02219; FLT -AP0824; COO -AG1487ZZZ; FIM -PA7274; CRO -8197; HEG -E768L; WFF -WA1066; NIP -J1320905; UFI -3010400; LUB -AP399; RYC -A1424; CMI -CDW12101; AMK -DA742; MFR -ELP3841; MHL -LX877; FRA -CA8797
1457433575	Air Filter Element, Engine	SKO-6Q0129620B, 6Q0129620	PBR -AI5290; PRF -A1270, A1127; DEP -AF20034; KNE -LX708, LX709; UFI -3013300; ALC -MD9768; FRA -CA9431, CA10409, CA9341; FLT -AP1892, AP1891; SFM -S8402A; GUD -AG1049; CPF -PA7384; WIX -WA6702; MFR -ELP3919, ELP3936; FIM -PA7384; THO -2705; BLP -ADV182201; MHL -LX708; PUR -A38344; HEG -E395L; MFI -MAP60119; CRO -8261; MN -C22954, C22953; LAT -ELP3919; CLF -MA1175; ACD -PC2186E; CHA -U719; TEN -A2048; CMI -EAF415; KSS -604AP
F026400600	Air Filter Element, Engine	MB-A6540940204, 6540940204	MHL -LX4802; HEG -E1620L; FLT -AP0349; KNE -LX4802; MN -C30030; UFI -30C3500; MFR -ELP9566, 9566VN
9951030130	Air Filter Element, Engine	MRU-13780M78122, 95669N38980, 13780M78131, 13780M78121	
F026400629	Air Filter Element, Engine	AUD-4E0129620B, 4E0129620E	FLT -AR3711; HEG -E725L; WIX -WA9480; MSF -R1227; MFR -EL9231; MN -C16521; DEP -PC3310E; CMI -EAF586

**Filters Cross Reference Chart**

Part Number	Product Description	Potential OE Part Number	Potential Comp. Part Number
F026400223	Air Filter Element, Engine	HON-17220RB0000, 17220RB6Z00	WIX -WA9679; FIM -PA7697; AMK -HA8633; HEB -J1324068; SFM -S3451A; SCT -SB2264; TEF -ARL1035; UFI -3045100; PRF -A1421; FLT -AP1064; CMI -EAF745; NIP -N1324066; ALC -MD8396; MHL -LX3697, LX2693; HEG -E523L; JPP -FA444S; FRA -CA10650; BLP -ADH22268; GUD -AG1559; MN -C18004; CHA -U880606
F002H24979	Air Filter Element, Engine	MRU-13780M65L00, 13780M76M00	
F002H20272	Air Filter Element, Engine	TAE-571209130103, G279009130131	
F002H26339	Air Filter Element, Engine	HYU-28113A0200	
F026400180	Air Filter Element, Engine	AUD-1K0129620	GUD -AG1153; FIM -PA7542; MN -C36188; WIX -WA9516; SFM -S3303A; FRA -CA10328; PBR -AI5441; MHL -LX1500; PRF -A1260; CHA -U883606; ALC -MD8402; UFI -3030300; ACD -PC3087E; HEG -E701L; FLT -AP0044; MFR -ELP9280; TEN -A2226
F026400051	Air Filter Element, Engine	NIS-1654600QAS, 1654600Q1F	MHL -LX2039, LX1849, LX3144; FRA -CA9621, CA10314, CA10827; MFR -ELP9102, ELP9086; WIX -WA9425; HEG -E1164L; KNE -LX2039, LX1849, LX3144; SFM -S9312A; FLT -AP1346; UFI -3032100; PRF -A1246, A1282, A1183; MN -C38751; TEN -A2139, A2209; CMI -EAF722, EAF556; FIM -PA7424, PA7527
1457433046	Air Filter Element, Engine	AUD-06C133843	WGA -FAP6007; SWA -30923334; CRO -8250; THO -2693; WIX -42972, WA6726; FIM -PA7373; MSF -P409; MHL -LX819, LX3817; AL -ALA8493; ALC -MD9620; FRA -CA9409; KSS -446AP, 50013446; GWI -AG213; FBI -23334; TEN -A2035; CMI -EAF422; TNO -AR2035PM; CHA -AF3593, CAF100814P, U814, U814606; MFR -ELP3958; FLT -AP1792; COO -AG1497; MN -C271921; KNE -LX819, LX3817; CPF -PA7373; MQP -VFA1030; CLF -MA1354; PUR -A45457; MCA -AF050; MPC -60817; MAR -71761663; VAO -585043; PBR -AI5254; PRF -A1119; HEG -E399L; SOP -LX819; SFM -S5302A, S0658A; MFI -MAP60135; LAT -ELP3958; SKR -A31060; GUD -AG1031; DEP -AF20072; ACD -PC2326E; LUB -AF3593; UFI -3016200; MYL -1121330003; BLP -ADV182208
0986AF2359	Air Filter Element, Engine	ISU-8979445700, 8973104420, 8971786100, 8979416551	WFF -WA1081; RYC -A1504; SKR -A1515

**Filters Cross Reference Chart**

Part Number	Product Description	Potential OE Part Number	Potential Comp. Part Number
1457433071	Air Filter Element, Engine	MB-1120940604, A1120940004, A2730940204, A1120940604, 2730940204, 1120940004, A2730940404, 2730940404	COO -AG1623; MYL -0120940040, 0120940040S; FIP -HP21562; SKR -A2614, A2614S; CRO -8397; MN -C369832, C36982, C3698; GUD -AG1027; MCA -AF593; ALC -MD9528; LUB -AF7987, AF7906; WIX -WA6587, 46799, 46298, WA6587OLD; SWA -10932507; MFI -MAP60125; CLF -MA3028; PBR -AI5214, AI5389; CHA -U785606, AF7987, U785, CAF100785P; TNO -AR3698PM; TEN -A2170, A21702; PRF -A1207, A12072; FRA -CA8768, CA7620, CA87682; MHL -LX804S, LX3971S, LX804; MPC -60803; CPF -PA73142, PA7314; FBI -32507; UFI -3053100; ACD -PC2509E; MQP -VFA979; CMI -EAF368; HEG -E455L01, E455L, E455L012; PUR -A34838; FIM -PA73142, PA7314; KSS -50013423, 500134232, 423AP, 4232AP; UNP -GFE2782; BBF -PA4440KIT; VAO -585190; MFR -ELP3911, JLP3911; TEF -ARL1120; AL -ALA8862; SFM -S3531A1, S3531A; KNE -LX804S, LX3971S, LX804; FLT -AP11832X, AP1183; BLP -ADU172201; WYT -WA50685; THO -2673
F026400130	Air Filter Element, Engine	NIS-16546JK20A	AL -8839; HEB -J1321068; PRF -A1532; AMK -NA2649; FRA -CA10544; BLP -ADN12267
F002H23426	Air Filter Element, Engine	MRU-13780M86J00	
1457433714	Air Filter Element, Engine	SKO-1J0129620	COO -AG1281; WFF -WCA8116; MPC -60034; CHA -U562; PRF -A379; CLF -MA1061; DEP -AF0273; CMI -EAF035; FIM -PA7216; MFI -MAP6976; PBR -AI5172; ALC -MD9422; CRO -8116; MHL -LX684; ACD -PC2515E; BAC -PA4111; MFR -ELP3781, ELP3713; KSS -503AP; LAT -ELP3713; UFI -3007700; FRA -CA8602, CA5827; SFM -S3077A; AL -ALA8428; WIX -42472, WA6333; GUD -AG920; RYC -A1432; THO -2553; MN -C37153; TEN -A146; PUR -A27766, A35267; HEG -E301L; KNE -LX684; LUB -AF7935, AP20; FLT -AP1491; CPF -PA7216
1987429166	Air Filter Element, Engine	DAO-96314494	TEN -A535; GUD -AG997; MN -C2119; PRF -A1060; WIX -WA6253; AL -ALA1903; BLP -ADG02219; FLT -AP0824; COO -AG1487ZZZ; FIM -PA7274; CRO -8197; HEG -E768L; WFF -WA1066; NIP -J1320905; UFI -3010400; LUB -AP399; RYC -A1424; CMI -CDW12101; AMK -DA742; MFR -ELP3841; MHL -LX877; FRA -CA8797
F002H24981	Air Filter Element, Engine	HYU-28113B4000	

### Filters Cross Reference Chart

Part Number	Product Description	Potential OE Part Number	Potential Comp. Part Number
F026400119	Air Filter Element, Engine	BMW-13717797465	ACD -PC3312E; TPR -501669; FIM -PA7656; MYL -3123210013; LAT -327; GUD -AG1412; VAO -585401; PBR -AI5524; TEN -A2316; FLT -AP0329; KSS -50014480, 4480AP; BLP -ADB112209; KNE -LX1640; CPF -PA7656; MN -C30135; SFM -S3357A; HEG -E1004L; FRA -CA10700; MPC -60220; CMI -EAF666; MSF -P521A; PRF -A1333; WIX -WA9601; LUB -AF3928; EOR -1612865880; MFR -ELP9315; MHL -LX1640; ALC -MD8452; CLF -MA3137; CHA -CAF100887P, U887; UFI -3035700
F026400287	Air Filter Element, Engine	SKO-5Q0129620B, 5Q0129620C, 5Q0129620D	MHL -LX3502, LX3503; WGA -FAP9065; TPR -114420; BLP -ADV182216; SFM -S3532A; WIX -WA9759; MN -C30005, C30004; MSF -P536; TEF -ARL6077; CMI -EAF818; ALC -MD8656; MGA -FA3406; HEG -E1090L; PRF -A1565, A1718; CLF -MA3184; KNE -LX3502, LX3503; FLT -AP1395, AP1396; FRA -CA11499; GUD -AG1573; CHA -CAF101064P; MFR -ELP9376, ELP9375; LAT -583; UFI -3053200; KSS -4529AP, 50014529; MYL -MAF0191, 1123210030; EOR -1612889280
F026400089	Air Filter Element, Engine	JAG-0613868A, GX739601BA, T4A6124	MHL -LX4335; PRF -A3009; KNE -LX4335; FLT -AP1938; MN -C26042; WIX -WA9837; HEG -E1629L
F026400468	Air Filter Element, Engine	MB-A6540940004, 6540940004	MHL -LX318811; MN -C45004; FLT -APO359; HEG -E1359L; GUD -AG1827; UFI -30B5600; WIX -WA9865; PRF -A1956
F026400508	Air Filter Element, Engine	BMW-13727843283	MHL -LX2075
F002H24971	Air Filter Element, Engine	TOY-178010N050	
F002H24982	Air Filter Element, Engine	MRU-13780M82P50	
F026400126	Air Filter Element, Engine	NIS-16546JG70A, 16546JD20A, 16546JD20B	ALC -MD8276; KNE -LX1983, LX3491; RYC -A1619; GUD -AG1368; FLT -AP1855; HEG -E1045L; SFM -S3352A; MYL -36123210010; CMI -CNS12298; MN -C24332, C24331; FIP -HP2246; MHL -LX1983, LX3491; AHK -2001135; MPC -60336; PRF -A1317; MAR -71760234; CLF -MA3065; SKR -A61360; CPF -PA7641; MFR -ELP9274; WIX -WA9563; MSF -P352; JPP -FA135S; ACD -PC3257E; HEB -J1321063; AMK -NA2646; UFI -3035200; KSS -4264AP, 50014264; FRA -CA10654; CHA -U918606, CAF100918P; NIP -J1321068; AL -8856; VAO -585152; BLP -ADN12259, ADN12256; MQP -VFA1213; QHZ -WA9563; MED -18366; GUF -A142J; TEN -A2297; MCA -AF096
F026400366	Air Filter Element, Engine	BMW-13717811026	MFR -EL9387; WIX -WA9723; CMI -EAF849; PRF -A1618; HEG -E1073L; MHL -LX3541; MN -C36014; GUD -AG1623; FLT -AK3626; COR -80004660; KNE -LX3541

### Filters Cross Reference Chart

Part Number	Product Description	Potential OE Part Number	Potential Comp. Part Number
F026400549	Air Filter Element, Engine	MBM-13717561235	HEG -E1172L; MHL -LX2038; UFI -3034600; PRF -A1498; MN -C37100; TEF -ARL6708; KNE -LX2038
F026400181	Air Filter Element, Engine		COO -AG1792; CMI -EAF729; MQP -LVFA1414; SKR -FA24240, A24240; HEG -E1000L; MCA -AF144; CHA -U860606, U860, CAF100860P; TEN -A2266; CLF -MA3175; CRO -8559; MHL -LX15912; MFR -ELP9309; PRF -A1289; ALC -MD8418; CPF -PA7574; FIM -PA7574; VAO -585276; UFI -3034100; WIX -WA9572, 49212; BLP -ADF122204; MN -C35177; KNE -LX15912; GUD -AG1424; MFI -MAP60205; FRA -CA10498; FLT -AP1656; MYL -5123210004; ACD -PC3231E; SFM -S3341A
1987429125	Air Filter Element, Engine	MRU-1378083000	THO -2310; AL -ALA82182; PBR -AI3368; FRA -CA3998; FLT -AM469; CRO -9124; MHL -LX446; FLG -AF4978; WGA -JFA807; TEN -A165; WFF -WA348; AMK -SA9054, SA9064; NIP -J1328007; CLF -MA599; RYC -A348; UFI -2709000; PRF -A352; FIM -FL6762; KNE -LX446; WIX -WA6534; MFR -EL3759; CHA -W254; COO -AG1221; GUD -AG1467; VIC -A944; MN -C1980; PUR -A34473
F026400712	Air Filter Element, Engine	MB-2780940004, A2780940004	FLT -AP1194; HEG -E1154L; KNE -LX4205; PRF -A1959; MN -C3397; MSF -P840; WIX -49704; GUD -AG1508; MHL -LX4205
F026400360	Air Filter Element, Engine	MBM-13718513944	KNE -LX4060, LX4059; TNO -AR22017PMS; GUF -A1374E, A1374EF; TEF -ART6701; JPP -FA0105JM; MED -18694, 18639; GUD -AG1729, AG1685; FLT -AP0264; MHL -LX4060, LX4059; CLF -MA3257; ALC -MD8810, MD8784; TEN -A2548, A2544; KSS -50014742, 4742AP, 4708AP, 50014708; AHK -FA0105JM; UFI -3062200, 3062100; SFM -S3621A, S3622A; CMI -EAF909, EAF884; WIX -WA9792, WA9791; MFR -ELP9412, ELP9488; FRA -CA11860, CA11888; MYL -3123210039; MN -C22018, C22017; CPF -PA7818, PA7822; AL -ALA18025; FIM -PA7818, PA7822; PRF -A1715, A1719; COO -PA7818; MQP -LVFA1568, LVFA1567; BLP -ADB112221, ADB112219; HEG -E1280L, E526L; FBI -109203, 109202
F002H23584	Air Filter, Complete, Engine	MHI-0313AAM01480N, 0313AC2261N	
1987432171	Cabin Filter	CHE-96425700, J96425700	COR -80000869; FRA -CF11414; CMI -EKF272; MN -CU2012; FLT -K1258; WGA -AKX3537; UFI -5314400; HEG -E3960LI; BLP -ADG02550; WIX -WP9378; PRF -AH354; MHL -LA624
F002H24939	Cabin Filter		MN -CU19005



**Filters Cross Reference Chart**

Part Number	Product Description	Potential OE Part Number	Potential Comp. Part Number
1987432188	Cabin Filter	FIA-71754151, 55702400, 71773192, 55702456, K6001073267, 77365638, K6000633317, 6000633317, 6001073267	FDB -MP193; TEN -E465, E443; UFI -5312400; HEG -E2939LI; MN -CU2243; BLP -ADZ92507; WIX -WP9250; DSO -DCF202P, DCF201K; GUD -AC70; FBI -27868; MCA -MP193; PBR -AH7203; CRO -E443; SFM -S3124C; MFR -ELR7187; UNP -GFE3246; VAO -715552, 708552; CMI -EKF137; DEP -TSP0325205; MAR -BCF201; COO -ACE184; FRA -CF10282; SWA -70927868; ALC -MS6339; CLF -NC2189; CPF -PC8170; COR -80000541, CP1221; KNE -LA306; AL -ALC5380; FLT -K1172; FIP -HC7141; MHL -LA306; PRF -AH244; HLA -PF144; EOR -1611635080; SOG -SIP1710; FIM -PC8170
1987435064	Cabin Filter	BMW-64119163328, 64119272641	MHL -LA467S; MN -CU25332; UFI -5322900; TEF -ACP5299; FRA -CF112202; PRF -AH3362; HEG -E2978LI2; KNE -LA467S
1987432164	Cabin Filter	HYU-S9713307010AT, 9713307010, 9713307010AT	DEP -TSP0325182; MSF -HB203; MFR -ELR7254; ALC -MS6294; AL -ALC5257; FRA -CF10627; KNE -LA471; GUD -AC94; HLA -PF188; CHA -CCF0034; SFM -S3116C; MED -17335F, 17335K; AHK -21KIK09; ASU -4025030; FLT -K1287; SWA -91924567; TEN -E496; HFR -17335F, 17335K; CMI -EKF184; NIP -J1340305; MHL -LA471; MN -CU1910; WIX -WP9344; CLF -NC2342; VAO -715524; LAT -R48; JPP -FAAKI09, 09KI09; DSO -DCF284P; FDB -MP220; WGA -AKX2005, AKX1988; MPC -65471; EOR -1611635880; PRF -AH301; FBI -24567; UFI -5311600; VEO -V53300001; COR -80000634, CP1237; QHZ -QAP400; HEG -E1976LI; ACD -PU1233E; AMK -KC6105; BLP -ADG02516; CPF -PC8248
1987432540	Cabin Filter	AUD-5Q0819644, 5Q0819644A	FBI -48465; KSS -50014682, 4682AC; HEG -E2998LI; FLG -AF56036; DEP -KF10023; FRA -CFP11643, CF11643; MQP -LVCF595; FLT -K1311; CHA -CCF0480; SKR -CA31110; MSF -HB252; SFM -S3298C; TEN -E683; MHL -LA1184, LA888; MFR -ELR7291; VAO -715806, T1019913H; KNE -LA1184, LA888; MED -17570; PRF -AH392; VEO -V10300003; SWA -30948465; AMK -FCA10023; BLP -ADV182526; ALC -MS6459; CMI -EKF328; CLF -NC2390; COR -CP1455, 80004514; WIX -WP2088; GUF -C1800E; UFI -5329800; DSO -DCF575P; MN -PF354, CU26009

**Filters Cross Reference Chart**

Part Number	Product Description	Potential OE Part Number	Potential Comp. Part Number
1987435005	Cabin Filter	FIA-A22002300, 51854923, 0000052126547	CLF -NC2385; SWA -70944783; PRF -AH371; UFI -5321000; COR -CP1451, 80004407; FBI -44783; MCA -MP406; MN -CU20006, PF480; MPC -65013; FRA -CF11470; CHA -CCF0473; WIX -WP2090; DEP -TSP0325344; FLT -K1322; ALC -MS6461; KNE -LA922; CPF -PC8340; TEF -ACP906; MQP -LVCF600; TEN -E665; SFM -S3210C; MFR -ELR7308; HEG -E3910LI; VEO -V24301115; CMI -EKF382; MED -17541; MHL -LA922; BLP -ADA102524; VAO -715755
1987435117	Cabin Filter		VAO -698775; FLT -K1265; MHL -LA62; WIX -24827; HEG -E1943LI; COR -80000065; TEF -ACP801; MN -CU5366; DSO -DCF256P
1987432012	Cabin Filter	SKO-1H0819644A, 1H0819644B	FDB -MP044, AKX35132, 21651912; DEP -CAF4, TSP0325004; HAF -HCF202; MHL -LA622, LA31; VAO -698160, 698679, 698885, 708159, 708160, 708679, 698159; KSS -50013703, 703AC; PBR -AH7003; MFR -ELR7033, ELR7004; UNP -GFE2907; CMI -EKF285, EAF199, EKF112; WFF -WACF0016; QHZ -QAP213, QAP113; FRA -CA5663, CF5663, CF8893; MQP -VCF116; TTV -TI558, TI553; BHT -352124001, 8FL352215081, 8FL352159421, 8FL352124001; MYL -1123190001; LUB -CAF1702, AC40; MFI -MAC8002; FLT -K1005, K1006; BLP -ADV182521; UFI -5300600, 5300640; MRO -8671002080; MED -17082; LAT -ELR7033, ELR7004; KNE -LA622, LA31; MCA -MP044; THO -29005; CLF -NC2012; BEH -9007436, 68797; HEG -E900LI; ACD -CAF4, PU1034E; CRO -E311, 8906; CPF -PC8005; COR -CP1027, CP1279, 21651912MX, CP102710, 80000817, 21651912; MN -CU2882, PF010; COO -ACE006; DSO -DCF001P, DCF461P; HFR -8300082; MAR -BCF122; SFM -S3006C, S0801C; RYC -RCA103P; SWA -30909446; MPC -65202, 67208; FIM -PC8001, PC8005; WIX -WP6812; MSF -HB104; GUD -AC23; PRF -AH104; PUR -C38907, C45383FD, I19236, C45383, C38901; ECO -14111, 302; VEO -10301013, V10301013; FIP -HC7010; AL -ALC52231, ALC5313, ALC5223; BHE -352124001, 8FL352215081, 8FL352159421, 8FL352124001; CHA -CAF1702, AC40, N113, N106, CCF0001; FBI -9446, 09446; TEN -E311
1987432081	Cabin Filter	MB-A2118300218, 2118300218	FLT -K1146A, K1146; WIX -WP9148; MCA -MP109; HEG -E989LI; ALC -MS6250; DEP -TSP0325208; UFI -5309500; MFR -ELR7146; MN -CU3172; CMI -EKF139; MHL -LA156; COR -21652863; HLA -PF011; VAO -698702; KNE -LA156; FDB -MP109



### Filters Cross Reference Chart

Part Number	Product Description	Potential OE Part Number	Potential Comp. Part Number
1987432057	Cabin Filter	SKO-6Q0820367A, 6Q0820367B, 6Q0820367	AL -ALC5319, ALC53191; VAO -698685, 698852, 708685; CLF -NC2047; CRO -E394; PUR -C38198, I19231; SFM -S3031C, S0813C; FDB -X35163, MP060; MFI -MAC8031; HEG -E961LI; MAR -BCF145; FIM -PC8077; MPC -65219; ACD -PU1021E; WIX -WP9036; MFR -ELR7076; FRA -CF9323; FIP -HC7067; THO -29048; PRF -AH191; BHT -8FL352159321; BHE -8FL352159321; QHZ -QAP324; FLT -K1079A, K1079; MSF -HB151; VEO -V103025261, V10302526, 228946, 10302526; MHL -LA120, LA522; CHA -CCF0320, N153; COR -21652356, CP1074, 21652356MX, CP107410; KNE -LA120, LA522; FBI -19590; UFI -5303100; CMI -EKF122; ECO -1542, 1442; MED -17081; MYL -1123190003; UNP -GFE2979; BLP -ADV182503; COO -ACE089; PBR -AH7055; CPF -PC8077; DSO -DCF006P, DCF462P; BEH -7402361; MN -CU2545, PF054; KSS -50013702, 702AC; DEP -TSP0325111; LAT -ELR7076; HFR -8300081; TEN -E394; MCA -MP060; GUD -AC39; MQP -VCF186
1987432190	Cabin Filter	LEX-8713907020, 8713902090, 87139YZZ16, 8713907010, 8713902020	AL -ALC5390; JPP -FAATY9, FAATY13, JFAATY9; UFI -5314700; MYL -30123200006, 30123190006; CHA -CCF0051; MCA -PF148, PF079, MP121, MP273; AHK -21TYTY9, 21TYTY13; FBI -27465, 30242; DSO -DCF356P; FIP -HC7138; PBR -AH7216, AH7222; SKR -CA1114; MPC -65561; CRO -E467, E524; NIP -J1342028, J1342024; DEP -TSP0325232, TSP0325232C; ACD -PU1204E; MFR -ELR7212; FRA -CF10322, CF10285; SFM -S3288C1, S3147C, S3282C1; ALC -MS6368; MN -PF260, CU1919, PF307; MQP -VCF397, VCF398; PRF -AH259, AH256; KSS -4239AC, 50014239; CMI -EKF185; KNE -LA655, LA516, LA1284, LA395; BLP -ADS72505, ADT32517, ADT32511, ADT32514; MHL -LA655, LA516, LA1284, LA395; HEB -J1342028, J1347008, J1342024, J1342026, J1342035; QHZ -QAP423; VEO -V70300009, V70300004; FLT -K1210; AMK -TC1018; MED -17423, 17423K; RYC -RCA178P; CPF -PC8195, PC8186; CLF -NC2358; UNP -GFE3256; TNO -CK1919, CK1919C; MSF -HB198; COR -CP1486, CP1227, 80000604, 80005175; GUD -AC72; WIX -24511, WP9290; COO -ACE185; VAO -715550, 708620, 715620, 708550; TEN -E467, E459; HEG -E2945LI; SWA -81930242, 81927465; MAR -BCF244

### Filters Cross Reference Chart

Part Number	Product Description	Potential OE Part Number	Potential Comp. Part Number
1987435053	Cabin Filter	MB-A2118301218, 2118301218	FBI -49662; KNE -LA455S, LA1117S; BLP -ADU172517; VEO -V30301059; SWA -10949662; MYL -0123190021S; MN -CU180002, PF211; MHL -LA455S, LA1117S
1987432190	Cabin Filter	LRG-LR055993	AL -ALC5390; JPP -FAATY9, FAATY13, JFAATY9; UFI -5314700; MYL -30123200006, 30123190006; CHA -CCF0051; MCA -PF148, PF079, MP121, MP273; AHK -21TYTY9, 21TYTY13; FBI -27465, 30242; DSO -DCF356P; FIP -HC7138; PBR -AH7216, AH7222; SKR -CA1114; MPC -65561; CRO -E467, E524; NIP -J1342028, J1342024; DEP -TSP0325232, TSP0325232C; ACD -PU1204E; MFR -ELR7212; FRA -CF10322, CF10285; SFM -S3288C1, S3147C, S3282C1; ALC -MS6368; MN -PF260, CU1919, PF307; MQP -VCF397, VCF398; PRF -AH259, AH256; KSS -4239AC, 50014239; CMI -EKF185; KNE -LA655, LA516, LA1284, LA395; BLP -ADS72505, ADT32517, ADT32511, ADT32514; MHL -LA655, LA516, LA1284, LA395; HEB -J1342028, J1347008, J1342024, J1342026, J1342035; QHZ -QAP423; VEO -V70300009, V70300004; FLT -K1210; AMK -TC1018; MED -17423, 17423K; RYC -RCA178P; CPF -PC8195, PC8186; CLF -NC2358; UNP -GFE3256; TNO -CK1919, CK1919C; MSF -HB198; COR -CP1486, CP1227, 80000604, 80005175; GUD -AC72; WIX -24511, WP9290; COO -ACE185; VAO -715550, 708620, 715620, 708550; TEN -E467, E459; HEG -E2945LI; SWA -81930242, 81927465; MAR -BCF244
1987432242	Cabin Filter	BMW-64319312316, 64312284827, 64319237158	PRF -AH3722; WIX -WP2076; MN -CU190042, CU19004; MHL -LA630S; COR -80001776, CP1434; CMI -EKF319; UFI -5325100; HEG -E2992LI2; FRA -CF114712; GUD -AC139; FLT -K13362X
1987432214	Cabin Filter		ALC -MS6418; KNE -LA449; SFM -S3183C; ACD -PU1236E; AHK -21SZZ09; WIX -WP9348; CPF -PC8300; CMI -EKF296; MYL -6123190018; MHL -LA449; MSF -HB208; BLP -ADK82508; HEG -E3908LI; MAR -BCF251; FRA -CF11244; TEN -E636; MN -PF329, CU2028; NIP -N1348007; HEB -J1348008; MQP -LVCF544; QHZ -QAP439; FBI -29212; JPP -FAASZ09; DSO -DCF311P; COR -80001036, CP1324; MED -17496; AL -ALC5508; UFI -5318300; VAO -715644; AMK -SC9509; DEP -TSP0325312C, TSP0325312; VEO -V40301112; MFR -ELR7264; CLF -NC2360; PRF -AH343; FLT -K1290

**Filters Cross Reference Chart**

Part Number	Product Description	Potential OE Part Number	Potential Comp. Part Number
1987435058	Cabin Filter	MB-1668300018, A1668300218, A1668300018, 1668300218	FBI -38781; HEG -E3900LI; GUF -C1807E; MQP -LVCF604; TNO -CK25002C; MN -CU25002, PF331; CMI -EKF400; TEN -E700; MED -17556; FLT -K1353; PRF -AH409; COR -CP1456, 80004550; MFR -ELR7292; MYL -0123190040; VEO -V30311058; GUD -AC135; WIX -WP10124, WP2134; DEP -KF10022; CPF -PC8379; VAO -715751; MSF -HB255; FRA -CF11719; MHL -LA877; SWA -10938781; BLP -ADU172505; MCA -MP432; KNE -LA877; ALC -MS6483; UFI -5332000
1987435143	Cabin Filter	MB-2478300900, A2478300900	
1987432057	Cabin Filter	VWW-6Q0820367A, 6Q0820367B, 6Q0820367	AL -ALC5319, ALC53191; VAO -698685, 698852, 708685; CLF -NC2047; CRO -E394; PUR -C38198, I19231; SFM -S3031C, S0813C; FDB -X35163, MP060; MFI -MAC8031; HEG -E961LI; MAR -BCF145; FIM -PC8077; MPC -65219; ACD -PU1021E; WIX -WP9036; MFR -ELR7076; FRA -CF9323; FIP -HC7067; THO -29048; PRF -AH191; BHT -8FL352159321; BHE -8FL352159321; QHZ -QAP324; FLT -K1079A, K1079; MSF -HB151; VEO -V103025261, V10302526, 228946, 10302526; MHL -LA120, LA522; CHA -CCF0320, N153; COR -21652356, CP1074, 21652356MX, CP107410; KNE -LA120, LA522; FBI -19590; UFI -5303100; CMI -EKF122; ECO -1542, 1442; MED -17081; MYL -1123190003; UNP -GFE2979; BLP -ADV182503; COO -ACE089; PBR -AH7055; CPF -PC8077; DSO -DCF006P, DCF462P; BEH -7402361; MN -CU2545, PF054; KSS -50013702, 702AC; DEP -TSP0325111; LAT -ELR7076; HFR -8300081; TEN -E394; MCA -MP060; GUD -AC39; MQP -VCF186

**Filters Cross Reference Chart**

Part Number	Product Description	Potential OE Part Number	Potential Comp. Part Number
1987432190	Cabin Filter	JAG-T2H8151	AL -ALC5390; JPP -FAATY9, FAATY13, JFAATY9; UFI -5314700; MYL -30123200006, 30123190006; CHA -CCF0051; MCA -PF148, PF079, MP121, MP273; AHK -21TYTY9, 21TYTY13; FBI -27465, 30242; DSO -DCF356P; FIP -HC7138; PBR -AH7216, AH7222; SKR -CA1114; MPC -65561; CRO -E467, E524; NIP -J1342028, J1342024; DEP -TSP0325232, TSP0325232C; ACD -PU1204E; MFR -ELR7212; FRA -CF10322, CF10285; SFM -S3288C1, S3147C, S3282C1; ALC -MS6368; MN -PF260, CU1919, PF307; MQP -VCF397, VCF398; PRF -AH259, AH256; KSS -4239AC, 50014239; CMI -EKF185; KNE -LA655, LA516, LA1284, LA395; BLP -ADS72505, ADT32517, ADT32511, ADT32514; MHL -LA655, LA516, LA1284, LA395; HEB -J1342028, J1347008, J1342024, J1342026, J1342035; QHZ -QAP423; VEO -V70300009, V70300004; FLT -K1210; AMK -TC1018; MED -17423, 17423K; RYC -RCA178P; CPF -PC8195, PC8186; CLF -NC2358; UNP -GFE3256; TNO -CK1919, CK1919C; MSF -HB198; COR -CP1486, CP1227, 80000604, 80005175; GUD -AC72; WIX -24511, WP9290; COO -ACE185; VAO -715550, 708620, 715620, 708550; TEN -E467, E459; HEG -E2945LI; SWA -81930242, 81927465; MAR -BCF244
1987432097	Cabin Filter	AUD-1K0819644B	MQP -VCF242; FLT -K1111; QHZ -QAP367; FRA -CF9922, CF11486; UFI -5314800; MSF -HB166; FBI -21312; VAO -698800, 708800, 815282, 983051G, 815281, 715800; MPC -65801; FIP -HC7124; MYL -1123190011; AL -ALC5245; FIM -PC8155; RYC -RCA149C; COO -ACE125; WGA -AKX1100; HLA -PF020; WIX -WP9146; MFR -ELR7127M, ELR7127; PRF -AH202, AH378; BIL -ADV182533; KNE -LA1811, LA1064, LA621, LA181; UNP -GFE3088; MCA -MP113, PF072; MED -17295; CLF -NC2132; FDB -MP113; CPF -PC8348, PC8155; CMI -EKF118; BLP -ADV182504; PUR -C35586, I19233; VEO -10301003, V103010031, V10301003; DEP -TSP0325174; PBR -AH7161; SWA -30921312; DSO -DCF449P, DCF049P; ACD -PU1084E; MN -CU2939, PF020; SFM -S3148C; KSS -749AC, 50013749; HFR -8300295; GUD -AC35; CHA -N158, CCF0303; HEG -E998LI; TEN -E672, E409; MHL -LA1811, LA1064, LA621, LA181; COR -CP1129, 21653024; MAR -BCF207
1987432210	Cabin Filter	LRG-JKR100200	MHL -LA381; PRF -AH229; MFR -ELR7153; AL -ALC5500; KNE -LA381; FLT -K1163

**Filters Cross Reference Chart**

Part Number	Product Description	Potential OE Part Number	Potential Comp. Part Number
1987432296	Cabin Filter	MBM-64319127515	PRF -AH300; DSO -DCF567P; ALC -MS6410; QHZ -QAP432; MYL -3123190009; ACD -PU1217E; BLP -ADB112508; MSF -HB238; WIX -WP9362; FRA -CF10831, CFP10831; FIM -PC8263; KNE -LA171, LA385, LA1056; VEO -V20301012; COR -CP1265, 80000740; FBI -28380; MHL -LA171, LA385, LA1056; MFR -ELR7274; GUD -AC107; DEP -TSP0325260; FLT -K1239; HEG -E2947LI; SFM -S3156C, S4175CA1; MN -PF256, CU4436; CMI -EKF180; MCA -MP287; MED -17475; SWA -11928380; MPC -65621; CPF -PC8263; TEN -E610; KSS -4565AC; MQP -LVCF524; VAO -990316C, 715586; CRO -E610; UFI -5315600; CLF -NC2321
1987435163	Cabin Filter	MB-A1678350200, 1678350200	MN -CU19014; LSA -LC19014; HEG -E5954LI
F002H24983	Cabin Filter	TOY-871390D060, 871390D190	
1987432246	Cabin Filter	NIS-272771HDKE, 272771HEOE, 272771HD0BKE, 272771HEOE	GUD -AC138; CMI -EKF366; HEG -E2997LI; FLT -K1302; COR -80001780; SKR -CA18250; PRF -AH341; MN -CU23011; FRA -CF11243; WIX -WP2026; BLP -ADN12521; MHL -LA635; UFI -5321500
1987432190	Cabin Filter	TOY-871390D070, 87139YZZ08, 8713907020, 871390D010, 8713906080, 8713902090, 8713952040, 8713906050, 8713907010, 8713930040, 8713952020, 8713930070, 87139YZZ16, 8713902020	AL -ALC5390; JPP -FAATY9, FAATY13, JFAATY9; UFI -5314700; MYL -30123200006, 30123190006; CHA -CCF0051; MCA -PF148, PF079, MP121, MP273; AHK -21TYTY9, 21TYTY13; FBI -27465, 30242; DSO -DCF356P; FIP -HC7138; PBR -AH7216, AH7222; SKR -CA1114; MPC -65561; CRO -E467, E524; NIP -J1342028, J1342024; DEP -TSP0325232, TSP0325232C; ACD -PU1204E; MFR -ELR7212; FRA -CF10322, CF10285; SFM -S3288C1, S3147C, S3282C1; ALC -MS6368; MN -PF260, CU1919, PF307; MQP -VCF397, VCF398; PRF -AH259, AH256; KSS -4239AC, 50014239; CMI -EKF185; KNE -LA655, LA516, LA1284, LA395; BLP -ADS72505, ADT32517, ADT32511, ADT32514; MHL -LA655, LA516, LA1284, LA395; HEB -J1342028, J1347008, J1342024, J1342026, J1342035; QHZ -QAP423; VEO -V70300009, V70300004; FLT -K1210; AMK -TC1018; MED -17423, 17423K; RYC -RCA178P; CPF -PC8195, PC8186; CLF -NC2358; UNP -GFE3256; TNO -CK1919, CK1919C; MSF -HB198; COR -CP1486, CP1227, 80000604, 80005175; GUD -AC72; WIX -24511, WP9290; COO -ACE185; VAO -715550, 708620, 715620, 708550; TEN -E467, E459; HEG -E2945LI; SWA -81930242, 81927465; MAR -BCF244
F002H24942	Cabin Filter	MRU-95850M66RC0	

**Filters Cross Reference Chart**

Part Number	Product Description	Potential OE Part Number	Potential Comp. Part Number
F002H24938	Cabin Filter	MRU-990J0M79GS0010	MN -CU17001
F002H24944	Cabin Filter	HYU-97133S5000, 97133F2000, 971332H001, 97133A0000	
1987432051	Cabin Filter	MB-1248300118, A124830011864, A1248350047, 1248350047, A1248300118, 124830011864	MHL -LA862S; ALC -MS6195; MCA -MP0102; COR -21651199; WIX -WP9332; FLT -K12422X; FDB -MP0102; MN -CU38222; MFR -JLR7080; HLA -PF045; HEG -E1913LI; PUR -C18156
1987435061	Cabin Filter		COR -80000412, CP1208; GUF -C1407E1; MHL -LA541; VAO -715687; BEH -9007820, 28406; COO -ACE095, ACE164; CRO -E455; BHE -8FL352159501; CMI -EKF280; UNP -GFE2980; WIX -WP9316; FRA -CF10129; CPF -PC8235; FLT -K1226; GUD -AC143; MQP -VCF209, LVCF547; HEG -E4901LIR; MN -CU28551, PF080RL
1987432540	Cabin Filter	VWW-5Q0819644, 5Q0819644A	FBI -48465; KSS -50014682, 4682AC; HEG -E2998LI; FLG -AF56036; DEP -KF10023; FRA -CFP11643, CF11643; MQP -LVCF595; FLT -K1311; CHA -CCF0480; SKR -CA31110; MSF -HB252; SFM -S3298C; TEN -E683; MHL -LA1184, LA888; MFR -ELR7291; VAO -715806, T1019913H; KNE -LA1184, LA888; MED -17570; PRF -AH392; VEO -V10300003; SWA -30948465; AMK -FCA10023; BLP -ADV182526; ALC -MS6459; CMI -EKF328; CLF -NC2390; COR -CP1455, 80004514; WIX -WP2088; GUF -C1800E; UFI -5329800; DSO -DCF575P; MN -PF354, CU26009
F002H24946	Cabin Filter	HYU-971330M000, 971334L000	
1987432116	Cabin Filter	LRG-LR029773, JKR100280, 1H5Z19G244CA	MCA -MP234; ALC -MS6333; FLT -K1218; WIX -WP9296; PRF -AH222; FRA -CF10087; FDB -MP234; CMI -EKF153; COO -ACE160; MN -CU2423; PUR -C35541; HLA -PF151; HEG -E4921LI; TEN -E450; UFI -5310500; DEP -TSP0325167; COR -80000060; MHL -LA360; MFR -ELR7125
F002H24984	Cabin Filter	MHI-1203CAA03680N	
F002H24945	Cabin Filter	HYU-971331S000	

**Filters Cross Reference Chart**

Part Number	Product Description	Potential OE Part Number	Potential Comp. Part Number
1987432097	Cabin Filter	VWW-1K0819644B, 1K0819644, 1K0819644A	MQP -VCF242; FLT -K1111; QHZ -QAP367; FRA -CF9922, CF11486; UFI -5314800; MSF -HB166; FBI -21312; VAO -698800, 708800, 815282, 983051G, 815281, 715800; MPC -65801; FIP -HC7124; MYL -1123190011; AL -ALC5245; FIM -PC8155; RYC -RCA149C; COO -ACE125; WGA -AKX1100; HLA -PF020; WIX -WP9146; MFR -ELR7127M, ELR7127; PRF -AH202, AH378; BIL -ADV182533; KNE -LA1811, LA1064, LA621, LA181; UNP -GFE3088; MCA -MP113, PF072; MED -17295; CLF -NC2132; FDB -MP113; CPF -PC8348, PC8155; CMI -EKF118; BLP -ADV182504; PUR -C35586, I19233; VEO -10301003, V103010031, V10301003; DEP -TSP0325174; PBR -AH7161; SWA -30921312; DSO -DCF449P, DCF049P; ACD -PU1084E; MN -CU2939, PF020; SFM -S3148C; KSS -749AC, 50013749; HFR -8300295; GUD -AC35; CHA -N158, CCF0303; HEG -E998LI; TEN -E672, E409; MHL -LA1811, LA1064, LA621, LA181; COR -CP1129, 21653024; MAR -BCF207
1987432075	Cabin Filter		HFR -8300020; HEG -E975LI; KNE -LA119; MCA -MP063, MC563; WIX -WP9104; MED -17020; QHZ -QAP313; FLT -K1060; MPC -65526; ACD -PU1013E; MYL -36123190000; CLF -NC2091; MN -CU2345, PF163; PBR -AH7088; SKR -CA11400; TEN -E407; FIM -PC8083; MAR -BCF159; UNP -GFE2974; FBI -19442; ALC -MS6185; COR -21652346, CP1068; CMI -EKF206; NIP -J1341002; GUD -AC31; AMK -NC2002; VEO -V38301003, 38301003; SFM -S3035C; UFI -5303500; FIP -HC7077; DEP -TSP0325059C, TSP0325108; HEB -J1341002; BLP -ADN12501; PRF -AH298, AH204; CPF -PC8083; ECO -1652; AHK -21NSNS4; KSS -50013933, 933AC; COO -PC8152, ACE106; MSF -HB160; MHL -LA119; MFR -ELR7113; THO -29051; FDB -MP063, X35171; CHA -CCF0354, N148; AL -ALC5330, ALC53301; PUR -C38186FD, C38186; DSO -DCF501P, DCF189P; VAO -701031, 698734, 715819; MQP -VCF220; JPP -JFAAN4, JFAANS4, FAANS4, FAAN4; FRA -CF9363; SWA -82919442

**Filters Cross Reference Chart**

Part Number	Product Description	Potential OE Part Number	Potential Comp. Part Number
1987435018	Cabin Filter		TEF -ACA213; MFR -ELR7290; FLT -K1350; CMI -EKF375; COO -PC8364; SFM -S3280C1; AL -ALC55161; FRA -CF11661; UFI -5342200; MSF -HB253; VIT -T4FWB; DEP -KF10020; LUC -LFCP223; COR -80001772; FIM -PC8364; MN -CU25007; BIL -ADF122520; BLP -ADF122520; HEG -E3905LI; KNE -LA875; WIX -WP2096; ALC -MS6466; MCA -MC898; MHL -LA875; EOR -1612919280; PRF -AH395
1987432084	Cabin Filter	TOY-8713912010, 8713952010, 8856852010, 885685201083	AHK -21TYTY2; HLA -PF121; NIP -J1342001; COO -ACE076; ALC -MS6188; FDB -MP104; MFR -ELR7122; WFF -WACF0040; DEP -TSP0325173, TSP0325149, TSP0325173C, TSP0325082; MPC -65550, 65551, 65557; FBI -24433; MSF -HB177; MCA -PF159, TY00166P, PF149, MP104; PRF -AH160; MAR -BCF189; IFL -CFI8856; COR -CP1085, 21652551; VEO -70300001, V70300001; MQP -VCF184; UNP -GFE2982; FRA -CF10139, CF9466, CF9566; SKR -CA3300, CAC3300; MN -PF121, CU1828; BLP -ADT32505, ADT32531; RYC -RCA140P; PBR -AH7104; HEB -J1342001; MYL -34123190005, 30123190001; GUD -AC58; BBF -PA4372; MHL -LA672, LA109; DSO -4531014, DCF357P; HEG -E2930LI; CHA -N188, CCF0123, CAF1751; FLT -K1271, K1083, K1183; FIM -PC8096; LUB -CAF1751; WIX -WP9192, 24900; CPF -PC8096; KSS -946AC, 50013946; CLF -NC2054; MED -17062; VIC -AC101E, AC101; FIP -HC7132; TEN -E364, E359; HFR -8300062; AL -ALC5221, ALC5222; AMK -TC1006, TC1019; QHZ -QAP318; KNE -LA672, LA109; PUR -C38188, I19209; SFM -S3050C, S0816C; JPP -JFAATY2, FAATY2; UFI -5305000; VAO -698681, 708681; CMI -EKF126; ACD -PU1164E



**Filters Cross Reference Chart**

Part Number	Product Description	Potential OE Part Number	Potential Comp. Part Number
1987432234	Cabin Filter	HON-80292TG0Q02, 80291TF0J01, 80292TG0Q01, 80291T5RA01, 80292TF0G01, 80291TF0E01, 80291T7MH01, 80292TGLE01, 80292TBAA11, 80292TG0T02, 80291TF3E01	SFM -S3160C; MN -PF353, CU21003; CLF -NC2357; VEO -V26301011, V26301010; FIP -HC7171; HEG -E3929LI; AMK -FCA10041, HC8122, HC8118; UNP -GFE3350; FBI -32609; VAO -715692; UFI -5316000; SWA -85932609; MQP -LVCF515; BLP -ADH22519, ADH22516, ADH22515; WIX -WP2038; CPF -PC8296; SKR -CA16130; JPP -FAAH012; DSO -DCF573P; CMI -EKF306; TEN -E632; HEB -J1344015, J1344021; DEP -TSP0325319; FRA -CF11182; ALC -MS6391; GUF -C1847E; TEF -ACP709; NIP -N1344015; FLT -K1298; MHL -LA1397, LA462; MFR -ELR7318; PRF -AH339; VIC -AC808E; MYL -31123190010, 31123200010; AL -ALC571413; GUD -AC105; KNE -LA1397, LA462; MED -17502; MSF -HB294; CHA -CCF0185, CCF005801C01; MCA -MP372; AHK -21H0H012; LA -462; COR -CP1334, 80001183, MP385, 80001184, CC1334
1987432012	Cabin Filter	VWW-1H0819644A, 1H0819644, 1H0819638B, 1H0819644, 1H0819638A, 1H0819644B	FDB -MP044, AKX35132, 21651912; DEP -CAF4, TSP0325004; HAF -HCF202; MHL -LA622, LA31; VAO -698160, 698679, 698885, 708159, 708160, 708679, 698159; KSS -50013703, 703AC; PBR -AH7003; MFR -ELR7033, ELR7004; UNP -GFE2907; CMI -EKF285, EAF199, EKF112; WFF -WACF0016; QHZ -QAP213, QAP113; FRA -CA5663, CF5663, CF8893; MQP -VCF116; TTV -TI558, TI553; BHT -352124001, 8FL352215081, 8FL352159421, 8FL352124001; MYL -1123190001; LUB -CAF1702, AC40; MFI -MAC8002; FLT -K1005, K1006; BLP -ADV182521; UFI -5300600, 5300640; MRO -8671002080; MED -17082; LAT -ELR7033, ELR7004; KNE -LA622, LA31; MCA -MP044; THO -29005; CLF -NC2012; BEH -9007436, 68797; HEG -E900LI; ACD -CAF4, PU1034E; CRO -E311, 8906; CPF -PC8005; COR -CP1027, CP1279, 21651912MX, CP102710, 80000817, 21651912; MN -CU2882, PF010; COO -ACE006; DSO -DCF001P, DCF461P; HFR -8300082; MAR -BCF122; SFM -S3006C, S0801C; RYC -RCA103P; SWA -30909446; MPC -65202, 67208; FIM -PC8001, PC8005; WIX -WP6812; MSF -HB104; GUD -AC23; PRF -AH104; PUR -C38907, C45383FD, I19236, C45383, C38901; ECO -14111, 302; VEO -10301013, V10301013; FIP -HC7010; AL -ALC52231, ALC5313, ALC5223; BHE -352124001, 8FL352215081, 8FL352159421, 8FL352124001; CHA -CAF1702, AC40, N113, N106, CCF0001; FBI -9446, 09446; TEN -E311

**Filters Cross Reference Chart**

Part Number	Product Description	Potential OE Part Number	Potential Comp. Part Number
1987432540	Cabin Filter	SKO-5Q0819644, 5Q0819644A	FBI -48465; KSS -50014682, 4682AC; HEG -E2998LI; FLG -AF56036; DEP -KF10023; FRA -CFP11643, CF11643; MQP -LVCF595; FLT -K1311; CHA -CCF0480; SKR -CA31110; MSF -HB252; SFM -S3298C; TEN -E683; MHL -LA1184, LA888; MFR -ELR7291; VAO -715806, T1019913H; KNE -LA1184, LA888; MED -17570; PRF -AH392; VEO -V10300003; SWA -30948465; AMK -FCA10023; BLP -ADV182526; ALC -MS6459; CMI -EKF328; CLF -NC2390; COR -CP1455, 80004514; WIX -WP2088; GUF -C1800E; UFI -5329800; DSO -DCF575P; MN -PF354, CU26009
1987432200	Cabin Filter	POR-99657221902, 99657221901	CLN -MC1257; FDB -AKX35154; MHL -LA323, LA32; HEG -E951LI; COR -21651920; AL -ALC5255; PRF -AH102; COO -ACE012; FRA -CF5846; MN -CU3360; GUD -AC36; UFI -5302800; KNE -LA323, LA32; FLT -K1020
1987432073	Cabin Filter		KNE -LA242; MHL -LA242; HLA -PF028; HEG -E968LI; MN -PF028, CU5141; FIP -HC7109; COR -CP1089, 21652709; RYC -RCA222C; MQP -VCF211; MPC -65600; ACD -PU1150E; FBI -19967; CPF -PC8099; CRO -E312; COO -PC8006, ACE103, ACE074; MFR -ELR7096; SFM -S0821C, S3162C; FRA -CF9534; TEN -E312; UFI -5316200; VEO -V253010751; VAO -708779; MYL -7123190002; KSS -4222AC, 50014222; CMI -EKF155; PUR -I19206, C18209; THO -29036; MAR -BCF187; MSF -HB188; PRF -AH103; CLF -NC2107; QHZ -QAP335; DSO -DCF517P, DCF098P; CHA -N169, CCF0327; WIX -WP9163, WP9162; MCA -MP097; UNP -GFE3019; AL -ALC590711; FLT -K1148; BLP -ADJ132517; FDB -MP097
1987435517	Cabin Filter	NIS-272774M425, 999M1VP001, B727Z5003, 272779W125, B72005M000, 999M1VP051, B727A79925, 2K00330361, 27277CL025H, 272774M400	UFI -5326000; HEG -E3977LI; MFR -ELR7140; MN -CU22003, CU2252; FLT -K1217; KNE -LA371; PRF -AH298; MHL -LA371

**Filters Cross Reference Chart**

Part Number	Product Description	Potential OE Part Number	Potential Comp. Part Number
1987432085	Cabin Filter	TOY-8713908030, 8713947010, 8713949010, 8850820120, 8850820210, 8713933010, 87139YZZ19, 8856802020, 8713932010, 8713906030, 8713906040, 8888041010, 871394701083, 8713928010, 87139YZZ05, 8888020090, 8713947020	MCA -PF033; KNE -LA477, LA673, LA647, LA131; ACD -PU1147E; CHA -N186; PBR -AH7189; HEB -J1342019, J1342018, J1347002; VAO -708796, 698796; FRA -CF9846; MFR -ELR7258, ELR7159; HEG -E2915LI; WFF -WACF5231; BLP -ADT32504; JPP -FAASB2, JFAAB2, FAAB2, JFAASB2; MQP -VCF226; FIP -HC7106; KSS -50013945, 945AC; HLA -PF122; TEN -E414; CLF -NC2151; VEO -V70300002, 70300002, V703000021; MHL -LA477, LA673, LA647, LA131; GUD -AC90; WIX -WP9026; RYC -RCA104P; SFM -S3103CA1, S3103C, S0814C, S0811C; UNP -GFE3060; CPF -PC8144; MYL -34123190005, 30123190005; FBI -24434; MSF -HB317, HB211, HB195; MED -17275, 17337; SKR -CAC1101; AL -ALC5231; FDB -MP105; NIP -J1342019, J1342018, J1347002; FLT -K1083A, K1083; AHK -21SBSB2; UFI -5310300; VIC -AC102, AC102E; DEP -TSP0325175C, TSP0325175; QHZ -QAP347, QAP405; HFR -8300275, 8300337; PRF -AH210; COR -CP1078, 21652539; PUR -C35516, I19229, C35479; MPC -65551; COO -ACE120; CMI -EKF189; DSO -DCF353P; AMK -TC1003, TC1011C, SC9605; MN -PF122, CU2131
1987432070	Cabin Filter	MB-A2038300118, 2038300118	SFM -S3094C; COR -CP1075, 21652358; CMI -EKF244; FLT -K1106, K1106A; PUR -C28190, I19223; CPF -PC8147; KSS -50013718, 718AC; FRA -CF9905; WIX -WP9102; DEP -TSP0325083; FIP -HC7051; ACD -PU1060E; HEG -E970LI; VAO -698700, 708700; MQP -VCF386; UFI -5309400; MSF -HB164; PBR -AH7170; VEO -30301016, V30301016; MAR -BCF157; CLF -NC2098; AL -ALC5238; KNE -LA1092, LA129; TEN -E397; SWA -10919793; MYL -0123190003; HLA -PF041; MPC -66624, 65807; QHZ -QAP311; BLP -ADU172532; HFR -8300106; MFR -ELR7084; MCA -MP059, MC574RL; MED -17106; CRO -E397; FIM -PC8147; FBI -19793; DSO -DCF026P; MHL -LA1092, LA129; MN -PF041, CU3461; PRF -AH194; THO -29035; FDB -MP059; CHA -N166, CCF0168, N118
1987435064	Cabin Filter		MHL -LA467S; MN -CU25332; UFI -5322900; TEF -ACP5299; FRA -CF112202; PRF -AH3362; HEG -E2978LI2; KNE -LA467S

**Filters Cross Reference Chart**

Part Number	Product Description	Potential OE Part Number	Potential Comp. Part Number
1987432247	Cabin Filter	REN-272772100R, 272774813R	AMK -NC2025; VAO -715721; COR -80001760; UFI -5322300; FRA -CF11119; MN -CU1629; GUD -AC134; AL -ALC5512; CMI -EKF305; WIX -WP2010; PRF -AH306; DEP -TSP0325333; FLT -K1230; ALC -MS6401; MFR -ELR7272; BLP -ADN12526; JPP -FAANS13; HEG -E2985LI
1987435026	Cabin Filter	CIT-6447XF, 9807746380, 1609998980	MQP -LVCF510; DEP -TSP0325246; SFM -S3154C; MED -17449X2; FIP -HC71392; MCA -PF073, MP2012; WIX -WP9318; CMI -EKF170; PRF -AH2612, AH261; MPC -65417; ACD -PU1239E; COO -ACE2202; CLF -NC2315; QHZ -QAP433; UFI -5315400; KNE -LA1241S, LA428S; HEB -J1342042; SWA -64927976; KSS -4285AC, 50014285; MN -CU290032, CU30392, PF202, PF487; HEG -E2977LI2; CPF -PC8218, PC82182; MSF -HB215; FLT -K12272X; AMK -TC1039; DSO -DCF362P, A22002800, DCF479P; ALC -MS6400; VEO -V42301212, V22301010; CRO -E475; MYL -11123190010; BLP -ADP152502, ADP152505; MAR -BCF262, BCF281; FRA -CF10536, CF105362; TEN -E4752, E475; MHL -LA1241S, LA428S; MFR -JLR7234; FBI -27976; GUD -AC106; VAO -708554, 715554; COR -CP1473, 80000839, 80004776, CP1282
1987432228	Cabin Filter	FIA-7739573, 77364561, A22002100	FRA -CF10413; MYL -2123200012; MQP -LVCF537; MHL -LA457; CMI -EKF198; AL -ALC5398; TEN -E471; FLT -K1228; KNE -LA457; PRF -AH265; MSF -HB233; COR -80001027, CP1316; MPC -65014; SFM -S3157C; MFR -ELR7273; VEO -V22301013; DEP -TSP0325318; FBI -29221; UFI -5315700; MAR -BCF245; HEG -E2987LI, E3958LI; SWA -62929221; HEB -J1348019; ACD -PU1213E; CPF -PC8200; ALC -MS6380; MED -17489; DSO -DCF363P; WIX -WP9320; QHZ -QAP438; VAO -715616; FIP -HC7143; BLP -ADP152503; MN -CU2040, PF308; CLF -NC2348
1987432072	Cabin Filter	FIA-46723245, 46723331, 77362394	MHL -LA144; HLA -PF040; UFI -5304300; FLM -FC0907; FRA -CF9408; VAO -698535; TEF -ACP131; FLT -K1101, K1104A; PUR -C28214; TEN -E403; MN -CU2335; HEG -E1962LI; ALC -MS6178, MS6245; CPF -PC8093; KNE -LA144; MFR -ELR7120; DEP -TSP0325079, TSP0325115, TSP0325152; CMI -EKF102; WIX -WP9130; GUD -AC115; COR -21652544; FIB -FB503; MCA -MP078; FIM -PC8093; CLF -NC2045, NC2104; PRF -AH201
F002H24940	Cabin Filter	MRU-95850M55R00, 95861M74L00, 95850M79M00	

**Filters Cross Reference Chart**

Part Number	Product Description	Potential OE Part Number	Potential Comp. Part Number
1987432097	Cabin Filter	SKO-1K0819644B, 1K0819644A	MQP -VCF242; FLT -K1111; QHZ -QAP367; FRA -CF9922, CF11486; UFI -5314800; MSF -HB166; FBI -21312; VAO -698800, 708800, 815282, 983051G, 815281, 715800; MPC -65801; FIP -HC7124; MYL -1123190011; AL -ALC5245; FIM -PC8155; RYC -RCA149C; COO -ACE125; WGA -AKX1100; HLA -PF020; WIX -WP9146; MFR -ELR7127M, ELR7127; PRF -AH202, AH378; BIL -ADV182533; KNE -LA1811, LA1064, LA621, LA181; UNP -GFE3088; MCA -MP113, PF072; MED -17295; CLF -NC2132; FDB -MP113; CPF -PC8348, PC8155; CMI -EKF118; BLP -ADV182504; PUR -C35586, I19233; VEO -10301003, V103010031, V10301003; DEP -TSP0325174; PBR -AH7161; SWA -30921312; DSO -DCF449P, DCF049P; ACD -PU1084E; MN -CU2939, PF020; SFM -S3148C; KSS -749AC, 50013749; HFR -8300295; GUD -AC35; CHA -N158, CCF0303; HEG -E998LI; TEN -E672, E409; MHL -LA1811, LA1064, LA621, LA181; COR -CP1129, 21653024; MAR -BCF207
1987432057	Cabin Filter	MHI-1203CAA02820N	AL -ALC5319, ALC53191; VAO -698685, 698852, 708685; CLF -NC2047; CRO -E394; PUR -C38198, I19231; SFM -S3031C, S0813C; FDB -X35163, MP060; MFI -MAC8031; HEG -E961LI; MAR -BCF145; FIM -PC8077; MPC -65219; ACD -PU1021E; WIX -WP9036; MFR -ELR7076; FRA -CF9323; FIP -HC7067; THO -29048; PRF -AH191; BHT -8FL352159321; BHE -8FL352159321; QHZ -QAP324; FLT -K1079A, K1079; MSF -HB151; VEO -V103025261, V10302526, 228946, 10302526; MHL -LA120, LA522; CHA -CCF0320, N153; COR -21652356, CP1074, 21652356MX, CP107410; KNE -LA120, LA522; FBI -19590; UFI -5303100; CMI -EKF122; ECO -1542, 1442; MED -17081; MYL -1123190003; UNP -GFE2979; BLP -ADV182503; COO -ACE089; PBR -AH7055; CPF -PC8077; DSO -DCF006P, DCF462P; BEH -7402361; MN -CU2545, PF054; KSS -50013702, 702AC; DEP -TSP0325111; LAT -ELR7076; HFR -8300081; TEN -E394; MCA -MP060; GUD -AC39; MQP -VCF186
1987432132	Cabin Filter	HYU-S971331J000AT, 971331J000, 971331J500, 971331J000AT	BLP -ADG02549; WIX -WP2002; PRF -AH3102; MHL -LA495; COR -80001448; CMI -EKF308; MN -CU290022; HEG -E3915LI2; KNE -LA495; FLT -K12572X; GUD -AC101; FRA -CF109332; UFI -5316300

**Filters Cross Reference Chart**

Part Number	Product Description	Potential OE Part Number	Potential Comp. Part Number
1987435079	Cabin Filter	JEE-68079487AA, 68079487AB	MHL -LA1594; UFI -5332500; BLP -ADA102517; TEF -ACP794; GUD -AC158; FLT -K1356; HEG -E3995LI; KNE -LA1594; MCA -MP436; PRF -AH361; FDB -AK351221; MN -CU27008
F002H24948	Cabin Filter	REN-U9585001	
0986AF5529	Cabin Filter	HYU-976171C200, 976171C001, 976171C000	MN -CU25062
0986AF5562	Cabin Filter Micro Clean	HYU-971332G000	MN -CU2648
0986AF5531	Cabin Filter Micro Clean	HYU-971332B010, 971333K000	MN -CU2362
0986AF5529	Cabin Filter Micro Clean	HYU-976171C200, 976171C001, 976171C000	MN -CU25062
1987432171	Cabin Filter Micro Clean	CHE-96425700, J96425700	COR -80000869; FRA -CF11414; CMI -EKF272; MN -CU2012; FLT -K1258; WGA -AKX3537; UFI -5314400; HEG -E3960LI; BLP -ADG02550; WIX -WP9378; PRF -AH354; MHL -LA624
1987435574	Cabin Filter, Activated Carbon	REN-272774936R	MN -CUK1629; PRF -AHC306; MHL -LAK852; SKR -CAC18201; FDB -AK359826; FLT -K1230A; HEG -E2985LC; UFI -5428500; KNE -LAK852
1987435582	Cabin Filter, Activated Carbon	BMW-64116835406, 64116835405, 6835405, 64316835405, 64316835406	FLT -K1342A2X; KNE -LAK1156S; MN -CUK230152; MCA -MC9522; HEG -E3950LC2; PRF -AHC4282; UFI -5427900; MHL -LAK1156S
1987432312	Cabin Filter, Activated Carbon		TTV -TI1558; HEG -E900LC; CHA -CCF0001C, CAF7702; FIM -PCK8072; BHE -352204001; TNO -CK5663C; KNE -LAK31, LAK622; FLT -K1006A; CLF -NC2074CA, MC1246; BHT -352204001; MPC -67208; AL -ALC6421; MCA -MC544; COO -ACE006; DEP -TSP0325004C; PUR -I19413; KSS -704ACC, 50013704; MAR -BCF322; UFI -5426300; MQP -VCF173; CPF -PCK8072; ACD -PUK1034E; RYC -RCA103P; COR -CC1027, 21651955; FDB -MC544, 21651955; PRF -AHC104; MN -KF010, CUK2882; PBR -AH7066, AK7066; DSO -DCF225K; VAO -708686, 698686; FRA -CFA8893; MYL -1123200001; ECO -411, 4111; MFI -K910C; ALC -MS6109C; LUB -CAF7702; WIX -WP6813; MHL -LAK31, LAK622; CMI -EKF112A; MED -17082K; FIP -HCK7010; VEO -10311013, V103110401, V10311013



### Filters Cross Reference Chart

Part Number	Product Description	Potential OE Part Number	Potential Comp. Part Number
1987432422	Cabin Filter, Activated Carbon	AUD-4F089838B, 4F0898439B, 4F0819439C, 4F0898438, 4F0819439B, 4F0898439C, 4F0898438C, 4F0898438A, 4F0819439A	MHL -LAK239, LAO239S, LAK239S; HEG -E1944LC, E1944LB2; AL -ALC65211; COR -21653066; MSF -HB435C; PRF -AHC2472, AHA2472, AHC247; SFM -S4153CA; LUC -LFCP337S; EOR -1640606680; KNE -LAO239S, LAK239S; TEN -EA4492; MN -CUK30232; WIX -WP9189; FRA -CFA102092; MCA -MC6852; COO -PCA81712; DEP -KF10233C; CMI -EKF164A; FDB -MC685; ALC -MS6316C; FLT -K1162A2X; MFR -JKR7158; FIM -PCK81712; BLP -ADV182515; UFI -5415300
1987432368	Cabin Filter, Activated Carbon	BMW-64316915764, 64116915764, 64316915763, 64319195193, 64319195194	MCA -MC612; FRA -CF10916; CMI -EKF289A; COR -21652852; MFR -EKR7163; MN -CUK2339; VAL -698862; GUD -AC179; UFI -5431800; WIX -WP2078; HEG -E2933LC; MCL -EKR7163; TEF -ACA530; KNE -LAK234; MHL -LAK234
1987435502	Cabin Filter, Activated Carbon	SKO-6R0819653	FLT -K1313A; UNP -GFE2978; UFI -5419900; PRF -AHC191; CMI -EKF332A; COO -PCK8092; SFM -S4199CA; FBI -37316; KSS -4511ACC, 50014511; HEG -E3919LC; VAO -715727; COR -CC1436, 80001784; AL -ALC6469; WIX -WP2087; MHL -LAK809; MCA -MC900; MN -KF200, CUK26010; CLF -NC2386CA; BLP -ADV182511; DEP -TSP0325339C; VEO -V10312529
1987432597	Cabin Filter, Activated Carbon	AUD-1K2819653A, 1K2819653B	SWA -30105791, 1421463; FRA -CFA11486; VAO -715665, 983186C; BLP -ADV182506, ADV182534; MN -KF020RL, CUK29391; MQP -LVCF501; DSO -DCF053K; TEN -EC672; CMI -EKF388A; COR -CC1298, 80000602; ACD -PUK1085E, PUK1177E; HEG -E998LC01, E998LCR; FBI -43457, 105791; MYL -1123200019; WIX -WP9359; UNP -GFE3089; CHA -CCF0303R; VEO -V10310002; CPF -PCK8348; KNE -LAK1811; MCA -MC572; PRF -AHC378; FLT -K1211A; MHL -LAK1811
1987432402	Cabin Filter, Activated Carbon	BMW-64319171858, 64316913506, 64319174372, 64319174371, 64316935823	HLA -KF005; MCA -MC6662; HEG -E1909LC; COO -PCK81682; RYC -RCA169C; FDB -MC6662; FLT -K1160A2X; MN -CUK3139; TEN -EC420; COR -21653064; DEP -TSP0325212C; MHL -LAK197, LAK197S; MFR -JKR7161; CMI -EKF158A; PRF -AHC219, AHC2192; FIM -PCK81682; UFI -5412700; FRA -CFA101032; ALC -MS6299C
1987432431	Cabin Filter, Activated Carbon	VWW-JZW819653E, 7H0819631A	HEG -E1910LC; FLT -K1155A; FRA -CFA9881; CMI -EKF163A; MHL -LAK182; MCA -MC641; WIX -WP9167; COO -PCK8158; HLA -NKF035; VAO -698768; FDB -MC641; MFR -EKR7129; COR -21653015; PRF -AHC209; MN -CUK2842; UFI -5414800

### Filters Cross Reference Chart

Part Number	Product Description	Potential OE Part Number	Potential Comp. Part Number
1987432597	Cabin Filter, Activated Carbon	VWW-1K2819653A, 1K2819653, 1K2819653B	SWA -30105791, 1421463; FRA -CFA11486; VAO -715665, 983186C; BLP -ADV182506, ADV182534; MN -KF020RL, CUK29391; MQP -LVCF501; DSO -DCF053K; TEN -EC672; CMI -EKF388A; COR -CC1298, 80000602; ACD -PUK1085E, PUK1177E; HEG -E998LC01, E998LCR; FBI -43457, 105791; MYL -1123200019; WIX -WP9359; UNP -GFE3089; CHA -CCF0303R; VEO -V10310002; CPF -PCK8348; KNE -LAK1811; MCA -MC572; PRF -AHC378; FLT -K1211A; MHL -LAK1811
1987435512	Cabin Filter, Activated Carbon	VWW-7P0819631	PRF -AHC353; CMI -EKF341A; WIX -WP2017; KNE -LAK855; FRA -CFA11429; UFI -5431200; MCA -MC917; FLT -K1269A; HEG -E2980LC; MN -CUK2847, CUK28471; MHL -LAK855; GUD -AC110
1987435582	Cabin Filter, Activated Carbon	MBM-64316835405	FLT -K1342A2X; KNE -LAK1156S; MN -CUK230152; MCA -MC9522; HEG -E3950LC2; PRF -AHC4282; UFI -5427900; MHL -LAK1156S
1987435502	Cabin Filter, Activated Carbon	VWW-JZW819653F, 6R0819653	FLT -K1313A; UNP -GFE2978; UFI -5419900; PRF -AHC191; CMI -EKF332A; COO -PCK8092; SFM -S4199CA; FBI -37316; KSS -4511ACC, 50014511; HEG -E3919LC; VAO -715727; COR -CC1436, 80001784; AL -ALC6469; WIX -WP2087; MHL -LAK809; MCA -MC900; MN -KF200, CUK26010; CLF -NC2386CA; BLP -ADV182511; DEP -TSP0325339C; VEO -V10312529
1987432415	Cabin Filter, Activated Carbon		SKR -CAC19220; FLT -K1251A; CMI -EKF151A; KNE -LAK463; PRF -AHC282; COO -PCK8250; WIX -WP9361; UFI -5417000; HEG -E2964LC; MN -CUK2436; COR -80001129; MHL -LAK463
1987435609	Cabin Filter, Activated Carbon	MB-2478300800, A2478307203, 2478307203, A2478300800	FDB -AK357055; MN -CUK28013
1987435546	Cabin Filter, Activated Carbon	MB-A2228300418, 2228300418, A2228300318, 2228300318	UFI -5429400; MHL -LAK1377S; MN -CUK270212; PRF -AHC5482; HEG -E3939LC2; KNE -LAK1377S
1987432369	Cabin Filter, Activated Carbon	POR-8K0819439B	MHL -LAK386; MN -CUK2450; UFI -5416800; FRA -CFA10458; PRF -AHC269; CMI -EKF106A; KNE -LAK386; FLT -K1278A; MCA -MC771; COR -80000880; HEG -E2948LC; MFR -EKR7220; WIX -WP9329; COO -PCK8210
1987435617	Cabin Filter, Activated Carbon	MB-A1678350400, 1678350400	



**Filters Cross Reference Chart**

Part Number	Product Description	Potential OE Part Number	Potential Comp. Part Number
1987435587	Cabin Filter, Activated Carbon	BMW-64319159606	KNE -LAK848S; UFI -5425500; VAO -715712; MHL -LAK848S; MN -CUK22084, CUK220084; PRF -AHC3844
1987435001	Cabin Filter, Activated Carbon	MB-2048300518, 2128300318, 2128300118, A2128300118, 2048300018, A2128300218, A2128300018, A2128300318, 2128300218, 2128300018, A2048300518, A2048300018	COR -80001527; PRF -AHC318; MFR -EKR7270; MHL -LAK413; GUD -AC89; HEG -E2954LC03; MN -CUK29005; FLT -K1246A; UFI -5416300; FRA -CFA10934; CMI -EKF176A; CPF -PCK8278; BLP -ADU172501
1987435522	Cabin Filter, Activated Carbon	CIT-6447XG, 647993, 9801448180	QHZ -QAP733; CPF -PCK82042; MCA -MC7012; CLF -NC2315CA; MSF -HB215C; COR -80000615, 80004703, CC1282; MED -17449KX2; PRF -AHC2612, AHC261; CRO -EC475; MQP -LVCF511; MHL -LAK428S, LAK428; KNE -LAK428; FBI -36027, 29220; BLP -ADP152501, ADP152506; VAO -715555; UFI -5417200; COO -ACE2042; AL -ALC6549; FRA -CFA104192, CFA10536; FLT -K1227A2X; DSO -A22101500, DCF073K; PBR -AK7251; CMI -EKF170A; DEP -TSP0325246C; VEO -V22311010; MYL -11123200010; MN -CUK30392, KF487, KF202, CUK29003, CUK290032; TEF -ACP7989; ACD -PUK1239E; WIX -WP9319; KSS -4286ACC, 50014286; MFR -JKR7234; SFM -S4172CA; HEG -E2977LC2; TEN -EC4752, EC475
1987432405	Cabin Filter, Activated Carbon	LRG-6G9N180543BA, LR019192, LR019589, 6G9N19N619BA, LR039621, LR056138, LR039612, LR000901, LR000899	COR -80004556, 80000713; MN -CUK2733; COO -PCK8198; FRA -CFA10435; MHL -LAK387; FIA -PCK8198; WIX -WP9309; CMI -EKF273A; HEG -E2949LC; DEP -TSP0325226C; PRF -AHC267; UFI -5415900; FLT -K1237A
1987435590	Cabin Filter, Activated Carbon	LEX-8713958010	AMC -TC1036; COO -PC8420; PRF -AHC484; MN -CUK22032; CMI -EKF422A; FLT -K1310A; FRA -CF11862; WIX -TC1036, WP2159

**Filters Cross Reference Chart**

Part Number	Product Description	Potential OE Part Number	Potential Comp. Part Number
1987432357	Cabin Filter, Activated Carbon	VWW-JZW819653A, 6Q0819653B, 6Q0819653	UNP -GFE2978; ALC -MS6226, MS6216C, MS6216; PRF -AHC191; FIM -PC8077, PCK8092; PUR -C38197FDP, C38197, I19409; VAO -701009, 698739; BLP -ADV182501; CPF -PCK8092; COR -CC1074, 21652357; QHZ -QAP624; BHE -8FL352215271; TEN -EC394; DEP -TSP0325111C; FLT -K1079A; TNO -CK9323C; FRA -CFA9404; MSF -HB151C; CLF -NC2097CA; ECO -542, 442; HEG -E961LC; FDB -X35662, MC560; MQP -VCF197; WIX -WP9037; MCA -MC560; KNE -LAK522, LAK120; PBR -AH7101, AK7101; COO -ACE090; MED -17081K; UFI -5411400; MHL -LAK522, LAK120; SFM -S4114CA; VEO -V10311043, 10311043; ACD -PUK1021E; CMI -EKF122A; MYL -1123200003; BHT -8FL352215271; MFR -EKR7076; DSO -DCF331K, DCF458K, DCF051K; AL -ALC64081, ALC6408; FIP -HCK7067; BEH -7402360; LAT -EKR7076; MPC -66613, 67219; MFI -K927C; MAR -BCF345; FBI -19592; KSS -50013941, 941ACC; MN -CUK2545, KF054
1987435604	Cabin Filter, Activated Carbon	BMW-64119382886	MHL -LAK1398; KNE -LAK1398; MN -CUK30007; HEG -E4980LC
1987432424	Cabin Filter, Activated Carbon	BMW-64316962551, 64319142115, 64319313519, 64316925982, 80000064, 64316946628, 64316962549, 64316962553	CMI -EKF107A; ALC -MS6305C; UFI -5415400; HLA -KF141; MN -CUK8430; FLT -K1169, K1169A; PUR -C25624, C29111; FRA -CFA10206; DEP -TSP0325184C; COR -80000064; FIM -PCK8172; HEG -E1959LC; FDB -MC695; COO -PCK8172; MHL -LAK248; MFR -EKR7151; MCA -MC695; PRF -AHC246; WIX -WP9233; TEN -EC448; KNE -LAK248
1987435508	Cabin Filter, Activated Carbon	MB-2308300418, A2308300418	CMI -EKF298A; MN -CUK22412; PRF -AHC4072; FRA -CFA117172; MHL -LAK278S; HEG -E1919LC2
1987432371	Cabin Filter, Activated Carbon	AUD-4B0819439B, 8E0819439C, 4B0819439C	STG -3214893; EOR -1631810280, E146052; FLT -K1078, K1078A; PUR -C35484; KNE -LAK93; CLF -NC2108CA; CMI -EKF237A; COR -CC1088, 21652713; ALC -MS6202C, MS6202, MS6177; CPF -PCK8103; DSO -DCF054K; MN -CUK3037; DEP -TSP0325067, TSP0325112C; TEN -EC387; THO -29029; PBR -AH7118, AK7118; MFR -EKR7092; FIP -HCK7049; BLP -ADV182508; MCA -MC606; FIM -PCK8103; HEG -E955LC; SOG -SIC1789; CRO -EC387; SFM -S4101CA; VAO -701023, 698606, 708683, 708606, 698683; WIX -WP6999; UFI -5410100; FDB -MC606; ACD -PUK1044E; FBI -19588; HLA -KF048; PRF -AHC184; FRA -CFA9548; AL -ALC6410; MHL -LAK93

### Filters Cross Reference Chart

Part Number	Product Description	Potential OE Part Number	Potential Comp. Part Number
1987435538	Cabin Filter, Activated Carbon	BMW-64116823726, 64319297750, 64116823725, 64319390445, 64119321875	ALC -MS6487C; MSF -HB264C; VAO -715811; MCA -MC9522; HEG -E3950LC2; PRF -AHC4282; CMI -EKF379A2; COR -80004825, CC1478; FBI -45865; VEO -V20311052; SWA -20945865; MED -17563KX2; MQP -LVCF597; FLT -K1342A2X; DSO -CZ14520219X; BLP -ADB112512; KNE -LAK1156S; CPF -PCK84082; MYL -3123200025S; KSS -4621ACC; MN -CUK230052, KF432; TEN -EC7222; UFI -5427900; MHL -LAK1156S; FRA -CFA118152; MFR -JKR7305
1987432537	Cabin Filter, Activated Carbon	FIA-77365764	UFI -5416200; FRA -CFA10365; AL -ALC64591; VAO -701003, 715553; CLF -NC2189CA; TNO -CK2243C, EC465; MCA -MC693; COO -ACE194; MFR -EKR7187; SFM -S4162CA; WIX -WP9251; FLT -K1172A; HEG -E2939LC; MHL -LAK373; CRO -EC465; QHZ -QAP720; MN -KF434, CUK2243; VEO -V40311004; KSS -4231ACC, 50014231; CPF -PCK8194; MQP -LVCF570; BLP -ADW192503; DSO -DCF201K, A22100900; CMI -EKF137A; DEP -TSP0325205C; COR -80000777, CC1221; PRF -AHC244; MPC -67710; FBI -32369
1987432531	Cabin Filter, Activated Carbon		MFR -EKR7118; COO -ACE131; CPF -PCK8240, PCK8085; CLF -NC2128CA; BEH -68297, 7402363, B0954, 9016750, 9007827, 68298; MCA -MC646; CRO -EC423; PRF -AHC173, AHC304; DSO -DCF343K, DCF072K, DCF352K; TNO -CK9396C; TEN -EC423; QHZ -QAP321; FBI -19538; CMI -EKF132A, EKF280A; HEG -E1916LC01, E1916LC; FRA -CFA9396, CFA9909; PUR -C38194; BHE -8FL352215291, 8FL352215301, 8FL352215281; GUF -C1407ECA1, C1407ECA; KSS -4612ACC; MHL -LAK541, LAK54; MPC -66612, 66417, 67852; COR -80000069, CC1060, 21652996, CC1208; ACD -PUK1156E; MYL -5123200000, 5123200003; MN -KF080, CUK28551, KF080RL; VAO -715571, 715512; VEO -V95311215, V95311213, 95311213, 95311215; FDB -21651295; ALC -MS6474C, MS6181C; AL -ALC6313; MQP -LVCF548; SFM -S4126CA; UFI -5412600; DEP -TSP0325088C; WIX -WP9317; FLT -K1226A; BLP -ADF122522, ADF122523; KNE -LAK541, LAK54

### Filters Cross Reference Chart

Part Number	Product Description	Potential OE Part Number	Potential Comp. Part Number
1987432312	Cabin Filter, Activated Carbon	VWW-1H0091800, 8L0091800, 1H0091800SE, 1H0091800	TTV -TI1558; HEG -E900LC; CHA -CCF0001C, CAF7702; FIM -PCK8072; BHE -352204001; TNO -CK5663C; KNE -LAK31, LAK622; FLT -K1006A; CLF -NC2074CA, MC1246; BHT -352204001; MPC -67208; AL -ALC6421; MCA -MC544; COO -ACE006; DEP -TSP0325004C; PUR -I19413; KSS -704ACC, 50013704; MAR -BCF322; UFI -5426300; MQP -VCF173; CPF -PCK8072; ACD -PUK1034E; RYC -RCA103P; COR -CC1027, 21651955; FDB -MC544, 21651955; PRF -AHC104; MN -KF010, CUK2882; PBR -AH7066, AK7066; DSO -DCF225K; VAO -708686, 698686; FRA -CFA8893; MYL -1123200001; ECO -411, 4111; MFI -K910C; ALC -MS6109C; LUB -CAF7702; WIX -WP6813; MHL -LAK31, LAK622; CMI -EKF112A; MED -17082K; FIP -HCK7010; VEO -10311013, V103110401, V10311013
1987432571	Cabin Filter, Activated Carbon	MB-1728350047, A1728350047, 1718300418, A1718300418	LSA -LC3621C; PRF -AHC342; MHL -LAK246; WIX -WP9273; CMI -EKF299A; FLT -K1205A; MN -CUK3621; HEG -E2904LC; TEF -ACP606; MCA -MC675; FRA -CFA11239; MFR -EKR7172; UFI -5414900; GUD -AC186
1987435501	Cabin Filter, Activated Carbon	REN-8201370532, 7711426872	HEG -E2905LC; PRF -AHC207; COR -80004402; UFI -5423200; FRA -CFA9691; MHL -LAK230; MN -CUK1829; KNE -LAK230; FLT -K1152A
1987432542	Cabin Filter, Activated Carbon	BMW-64319395930, 9312318, 64319312318, 64319237157, 64312284828, 64319312317	FRA -CFA114712; CMI -EKF319A; MCA -MC922; PRF -AHC3722; SWA -20934814; MQP -LVCF568; KSS -4560ACC; MHL -LAK1149S, LAK630S; DEP -TSP0325343C; UFI -5424100; VEO -V20311045; VAO -715713, 815304, 815303; MYL -3123200023S; AL -ALC6474; KNE -LAK1149S, LAK630S; TNO -CK19004C2, CKA190042; CPF -PCK83412; ALC -MS6433C; TEN -EC6662; SFM -S4241CA; HEG -E2992LC2; FLT -K1336A2X; WIX -WP2077; TEF -ACA5289; SOG -SIC3667; MFR -JKR7287; MSF -HB260C; MED -17533KX2; COR -80001777, CC1434; MN -CUK190042, CUK19004, KF477; FBI -34814
1987432419	Cabin Filter, Activated Carbon	BMW-64316945586, 64119248295, 64119248294, 64116945594	SOG -SIC3264; WIX -WP9339; FBI -28414; MN -CUK29412; HEG -E2944LC2; VAO -715584; KNE -LAK221S; PRF -AHC3492; FRA -CFA109202; TEF -ACP5279; CPF -PCK83072; MFR -JKR7276; COR -CC1283, 80000848; MHL -LAK221S; CMI -EKF171A; UFI -5424300; FLT -K1270A2X; BLP -ADB112501

### Filters Cross Reference Chart

Part Number	Product Description	Potential OE Part Number	Potential Comp. Part Number
1987432568	Cabin Filter, Activated Carbon	JAG-MF1455700380, C2Z6525	GUD -AC119; MN -CUK2030; HEG -E5948LC; MHL -LAK454; BLP -ADJ132501; COR -80001179; CMI -EKF359A; FLT -K1429A; UFI -5429000
1987432357	Cabin Filter, Activated Carbon	SKO-6Q0819653B, 6Q0819653	UNP -GFE2978; ALC -MS6226, MS6216C, MS6216; PRF -AHC191; FIM -PC8077, PCK8092; PUR -C38197FDP, C38197, I19409; VAO -701009, 698739; BLP -ADV182501; CPF -PCK8092; COR -CC1074, 21652357; QHZ -QAP624; BHE -8FL352215271; TEN -EC394; DEP -TSP0325111C; FLT -K1079A; TNO -CK9323C; FRA -CFA9404; MSF -HB151C; CLF -NC2097CA; ECO -542, 442; HEG -E961LC; FDB -X35662, MC560; MQP -VCF197; WIX -WP9037; MCA -MC560; KNE -LAK522, LAK120; PBR -AH7101, AK7101; COO -ACE090; MED -17081K; UFI -5411400; MHL -LAK522, LAK120; SFM -S4114CA; VEO -V10311043, 10311043; ACD -PUK1021E; CMI -EKF122A; MYL -1123200003; BHT -8FL352215271; MFR -EKR7076; DSO -DCF331K, DCF458K, DCF051K; AL -ALC64081, ALC6408; FIP -HCK7067; BEH -7402360; LAT -EKR7076; MPC -66613, 67219; MFI -K927C; MAR -BCF345; FBI -19592; KSS -50013941, 941ACC; MN -CUK2545, KF054
1987432300	Cabin Filter, Activated Carbon	SKO-1J0819644A	VEO -10311040; KSS -725ACC; HEG -E900LC; COO -ACE048, ACE047; WIX -WP6895; FDB -21651967, MC592, AKX35634, AKX35605, 21651955; UFI -5410900; DEP -TSP0325004, TSP0325027C; SOG -SIC1785; ALC -MS6109; CRO -EC381, E381; MN -CUK2862, CU2862; UNP -GFE3003; MQP -VCF326, VCF146, VCF166; QHZ -QAP545, QAP245; WFF -WACF0016; KNE -LAK63; FBI -11566; DSO -DCF002K; ECO -511, 411; EOR -1631809280, E146057; MCA -MC592; MAR -BCF340; VAO -708716, 701016, 698716; CPF -PCK8045; RYC -RCA103P; GUD -AC18; PRF -AHC178; MPC -66208, 67202, 66227, 65220; MHL -LAK63; FIM -PCK8045, PC8045; PBR -AK7021, AH7021; TEN -EC381, E381; BEH -7401359; CMI -EAF201, EKF127A; MFR -EKR7004; PUR -C18117, C45383; LAT -EKR7004; AL -ALC6307; FLT -K1047A, K1006A; LUB -CAF7702; ACD -PUK1083E; BHT -8FL352203001, 352203001, 8FL352204001; COR -21651967, CC1028; HLA -KF043; FRA -CFA8869, CF8869; FIP -HCK7023; THO -29021; CLF -NC2082CA; SFM -S4109CA

### Filters Cross Reference Chart

Part Number	Product Description	Potential OE Part Number	Potential Comp. Part Number
1987435509	Cabin Filter, Activated Carbon	JAG-6W83020B02AC, 6W8319G244AA, 6W8318D483AA, C2P2410	MHL -LAK364; BLP -ADJ132513; VAO -715640; MN -CUK26011, CUK260112
1987432425	Cabin Filter, Activated Carbon	LRG-8H4219G244BA, JMO000010, JM0000010, LR026132, LR032199, LR161567	KSS -765ACC, 50013765; JPP -FAALR1, JFAALR1; VAO -815343, 698776, 815344; QHZ -QAP634; TNO -CK5366C; CPF -PCK8262; BLP -ADJ132504; HEG -E1943LC; SFM -S4128CA; MCA -MC649; AL -ALC64481; GUF -C1422ECA; CHA -CCF0162C, N231; HLA -KF056; DEP -TSP0325161C; FBI -21125; FLT -K1265A, K1265; FRA -CFA10830; DSO -DCF340K; UNP -GFE3286; AHK -21LRLR1; PRF -AHC299; ACD -PUK1184E; MYL -3123200013; MHL -LAK62; UFI -5412800; FDB -MC649; COR -CC1155, 21652916; MSF -HB180C; MN -CUK5366, KF056; CMI -EKF254A; VEO -V203110391, V20311039, 20311039; KNE -LAK62; MQP -VCF358; WIX -WP9327, 24827; GUD -AC196; MPC -66614; TEN -EC609; CLF -NC2311CA; MFR -EKR7108; MED -17096K; PUR -C15637; MFI -K9073C; RYC -RCA135C; CRO -EC609; TEF -ACP801; SWA -20921125
1987432431	Cabin Filter, Activated Carbon	POR-95557221910	HEG -E1910LC; FLT -K1155A; FRA -CFA9881; CMI -EKF163A; MHL -LAK182; MCA -MC641; WIX -WP9167; COO -PCK8158; HLA -NKF035; VAO -698768; FDB -MC641; MFR -EKR7129; COR -21653015; PRF -AHC209; MN -CUK2842; UFI -5414800
1987432369	Cabin Filter, Activated Carbon	AUD-8K0819439A, 8K0819439B	MHL -LAK386; MN -CUK2450; UFI -5416800; FRA -CFA10458; PRF -AHC269; CMI -EKF106A; KNE -LAK386; FLT -K1278A; MCA -MC771; COR -80000880; HEG -E2948LC; MFR -EKR7220; WIX -WP9329; COO -PCK8210

### Filters Cross Reference Chart

Part Number	Product Description	Potential OE Part Number	Potential Comp. Part Number
1987432300	Cabin Filter, Activated Carbon	AUD-1J0819644A, JZW819653	VEO -10311040; KSS -725ACC; HEG -E900LC; COO -ACE048, ACE047; WIX -WP6895; FDB -21651967, MC592, AKX35634, AKX35605, 21651955; UFI -5410900; DEP -TSP0325004, TSP0325027C; SOG -SIC1785; ALC -MS6109; CRO -EC381, E381; MN -CUK2862, CU2862; UNP -GFE3003; MQP -VCF326, VCF146, VCF166; QHZ -QAP545, QAP245; WFF -WACF0016; KNE -LAK63; FBI -11566; DSO -DCF002K; ECO -511, 411; EOR -1631809280, E146057; MCA -MC592; MAR -BCF340; VAO -708716, 701016, 698716; CPF -PCK8045; RYC -RCA103P; GUD -AC18; PRF -AHC178; MPC -66208, 67202, 66227, 65220; MHL -LAK63; FIM -PCK8045, PC8045; PBR -AK7021, AH7021; TEN -EC381, E381; BEH -7401359; CMI -EAF201, EKF127A; MFR -EKR7004; PUR -C18117, C45383; LAT -EKR7004; AL -ALC6307; FLT -K1047A, K1006A; LUB -CAF7702; ACD -PUK1083E; BHT -8FL352203001, 352203001, 8FL352204001; COR -21651967, CC1028; HLA -KF043; FRA -CFA8869, CF8869; FIP -HCK7023; THO -29021; CLF -NC2082CA; SFM -S4109CA
1987432336	Cabin Filter, Activated Carbon	BMW-64319216590, 64319071935, 64319257504, 64312182458	HLA -KF053; CLF -NC2088CA; PRF -AHC187; KNE -LAK102; AL -ALC6303; HEG -E977LC; MN -CUK6724; COO -ACE116; FIM -PCK8053; MFR -EKR7098; VAO -698535, 698489; FRA -CF8913, CFA8913; WIX -WP9003; MHL -LAK102; FLT -K1136A; CMI -EKF255A; COR -21652336; ALC -MS6179C; TEN -EC390; PUR -C15510, C18127; FDB -MC538; UFI -5412100; MCA -MC538
1987432548	Cabin Filter, Activated Carbon	AUD-4H0819439	GUD -AC121; UFI -5422200; HEG -E2996LC; CMI -EKF327A; FRA -CFA11436; MHL -LAK667; KNE -LAK667; LSA -LC2641C; FLT -K1318A; PRF -AHC362; MN -CUK2641; WIX -WP2075; MCA -MC908; COR -80001756
1987435623	Cabin Filter, Activated Carbon	BMW-64319346267	LSA -LC6267C; HEG -E2933LC
1987432438	Cabin Filter, Activated Carbon	MB-A2218300018, 2218300718, A2218300718, 2218300018, A2218300318, 2218300318	FLT -K1201A2X; MN -CUK27222; COR -80000538; MHL -LAK292S; LSA -LC2722C2; WIX -WP9265; CMI -EKF300A; MCA -MC7392; PRF -AHC5592; HEG -E2919LC2

### Filters Cross Reference Chart

Part Number	Product Description	Potential OE Part Number	Potential Comp. Part Number
1987432300	Cabin Filter, Activated Carbon	VWW-1J0819644A, JZW819653, 1J0819644	VEO -10311040; KSS -725ACC; HEG -E900LC; COO -ACE048, ACE047; WIX -WP6895; FDB -21651967, MC592, AKX35634, AKX35605, 21651955; UFI -5410900; DEP -TSP0325004, TSP0325027C; SOG -SIC1785; ALC -MS6109; CRO -EC381, E381; MN -CUK2862, CU2862; UNP -GFE3003; MQP -VCF326, VCF146, VCF166; QHZ -QAP545, QAP245; WFF -WACF0016; KNE -LAK63; FBI -11566; DSO -DCF002K; ECO -511, 411; EOR -1631809280, E146057; MCA -MC592; MAR -BCF340; VAO -708716, 701016, 698716; CPF -PCK8045; RYC -RCA103P; GUD -AC18; PRF -AHC178; MPC -66208, 67202, 66227, 65220; MHL -LAK63; FIM -PCK8045, PC8045; PBR -AK7021, AH7021; TEN -EC381, E381; BEH -7401359; CMI -EAF201, EKF127A; MFR -EKR7004; PUR -C18117, C45383; LAT -EKR7004; AL -ALC6307; FLT -K1047A, K1006A; LUB -CAF7702; ACD -PUK1083E; BHT -8FL352203001, 352203001, 8FL352204001; COR -21651967, CC1028; HLA -KF043; FRA -CFA8869, CF8869; FIP -HCK7023; THO -29021; CLF -NC2082CA; SFM -S4109CA
1987435601	Cabin Filter, Activated Carbon	MB-A2058350047, 2058350147, A2068350100, 2068350100, 2058350047, A2058350147	COR -80005252; KNE -LAK1161; HEG -E4932LC; WIX -WP2185; FLT -K1416A; MN -CUK26023; MHL -LAK1161; FDB -AK359738
1987435592	Cabin Filter, Activated Carbon	NIS-999M1VS251, AY684NS001, 27277Z5000	AMK -NC2017, NC2002C; MHL -LAK371; VAO -715560; MN -KF264, CUK2252; TNO -CK9882C; KNE -LAK371; SFM -S0826CA; DSO -DCF273K; BLP -ADN12529, ADN12513; VEO -V38310002; HEG -E3977LC; SKR -CAC18120
1987435538	Cabin Filter, Activated Carbon	MBM-64116823725, 64119321875	ALC -MS6487C; MSF -HB264C; VAO -715811; MCA -MC9522; HEG -E3950LC2; PRF -AHC4282; CMI -EKF379A2; COR -80004825, CC1478; FBI -45865; VEO -V20311052; SWA -20945865; MED -17563KX2; MQP -LVCF597; FLT -K1342A2X; DSO -CZ14520219X; BLP -ADB112512; KNE -LAK1156S; CPF -PCK84082; MYL -3123200025S; KSS -4621ACC; MN -CUK230052, KF432; TEN -EC7222; UFI -5427900; MHL -LAK1156S; FRA -CFA118152; MFR -JKR7305



### Filters Cross Reference Chart

Part Number	Product Description	Potential OE Part Number	Potential Comp. Part Number
1987435589	Cabin Filter, Activated Carbon	FIA-71775823	MYL -2123200016; FBI -48524; SFM -S4248CA; CPF -PCK8340; MFR -EKR7308; MN -CUK20006, KF480; MHL -LAK922; GUF -C1811ECA; MED -17541K; TEN -EC665; UFI -5424800; PRF -AHC371; BLP -ADL142513; COR -CC1451, 80004544; FIM -PCK8340; FLT -K1322A; SWA -70948524; KNE -LAK922; FRA -CFA11470; AL -ALC6482
1987432597	Cabin Filter, Activated Carbon	SKO-1K2819653A, 1K2819653B	SWA -30105791, 1421463; FRA -CFA11486; VAO -715665, 983186C; BLP -ADV182506, ADV182534; MN -KF020RL, CUK29391; MQP -LVCF501; DSO -DCF053K; TEN -EC672; CMI -EKF388A; COR -CC1298, 80000602; ACD -PUK1085E, PUK1177E; HEG -E998LC01, E998LCR; FBI -43457, 105791; MYL -1123200019; WIX -WP9359; UNP -GFE3089; CHA -CCF0303R; VEO -V10310002; CPF -PCK8348; KNE -LAK1811; MCA -MC572; PRF -AHC378; FLT -K1211A; MHL -LAK1811
1987432405	Cabin Filter, Activated Carbon		COR -80004556, 80000713; MN -CUK2733; COO -PCK8198; FRA -CFA10435; MHL -LAK387; FIA -PCK8198; WIX -WP9309; CMI -EKF273A; HEG -E2949LC; DEP -TSP0325226C; PRF -AHC267; UFI -5415900; FLT -K1237A
1987435505	Cabin Filter, Activated Carbon	MB-2468300018, A2468300018, 2468300118, A2468300118	PRF -AHC402; GUD -AC137; MCA -MC955; MHL -LAK879; TEF -ACP604; CMI -EKF376A; FLT -K1346A; LSA -LC26007C; KNE -LAK879; MN -CUK26007; HEG -E2993LC; FRA -CFA11430; COR -80004409; WIX -WP2099; UFI -5423600
1987435501	Cabin Filter, Activated Carbon	DAC-7711426872	HEG -E2905LC; PRF -AHC207; COR -80004402; UFI -5423200; FRA -CFA9691; MHL -LAK230; MN -CUK1829; KNE -LAK230; FLT -K1152A
1987432548	Cabin Filter, Activated Carbon	BEY-4H0819439	GUD -AC121; UFI -5422200; HEG -E2996LC; CMI -EKF327A; FRA -CFA11436; MHL -LAK667; KNE -LAK667; LSA -LC2641C; FLT -K1318A; PRF -AHC362; MN -CUK2641; WIX -WP2075; MCA -MC908; COR -80001756
1987435512	Cabin Filter, Activated Carbon	POR-95857221900	PRF -AHC353; CMI -EKF341A; WIX -WP2017; KNE -LAK855; FRA -CFA11429; UFI -5431200; MCA -MC917; FLT -K1269A; HEG -E2980LC; MN -CUK2847, CUK28471; MHL -LAK855; GUD -AC110
1987432431	Cabin Filter, Activated Carbon	AUD-7H0819631A	HEG -E1910LC; FLT -K1155A; FRA -CFA9881; CMI -EKF163A; MHL -LAK182; MCA -MC641; WIX -WP9167; COO -PCK8158; HLA -NKF035; VAO -698768; FDB -MC641; MFR -EKR7129; COR -21653015; PRF -AHC209; MN -CUK2842; UFI -5414800

### Filters Cross Reference Chart

Part Number	Product Description	Potential OE Part Number	Potential Comp. Part Number
1987432407	Cabin Filter, Activated Carbon	POR-99757121900, 99657121902, 99757121901, 99657121903, 99657121901	VAO -708748; MN -CUK3360; MCA -MC555; PBR -AK7169; ACD -PUK1055E; WIX -WP6841; PRF -AHC527; MHL -LAK321; DEP -TSP0325019C; FRA -CFA5846; HEG -E951LC; FLT -K1020A; COR -21652541; MFR -EKR7027
1987435585	Cabin Filter, Activated Carbon	MB-1648300218, A1648300218	MN -CUK26462; MHL -LAK295S; MCA -MC7382; PRF -AHC2412; FLT -K1200A2X; LSA -LC738C2; UFI -5421500; COR -80000647; HEG -E2912LC2; WIX -WP9263; COO -PCK82602
1987435618	Cabin Filter, Activated Carbon	MB-1668308200, A1668307201, 1668300318, 1668307201, A1668308200, A1668300318	HFR -17551KX2; MED -17551KX2; ALC -MS6476C; CMI -EKF427A2; MSF -PRHB760C; HEG -E3909LC2; MN -CUK260282; MXG -KF6476CKPL; PRF -AHC3902; MHL -LAK878S; VEO -V30315009, V30311060; COR -80004552, CC1457; KNE -LAK878S
0986628630	Cabin Filter, Activated Carbon+	VWW-5Q0819669	PRF -AHA392; LSA -LC26009C; HEG -E2998LB; MHL -LAO888; MN -FP26009; KNE -LAO888
0986628559	Cabin Filter, Activated Carbon+	BEY-4H0819439	CMI -EKF327A; MHL -LAO667; PRF -AHA362; FRA -CFA11436; VAO -715733; GUD -AC121; FLT -K1318A; KNE -LAO667; COR -49408801; MCA -MC908; MN -FP2641
0986628558	Cabin Filter, Activated Carbon+	ROL-64119272642	CMI -EKF320A; VAO -715690; MN -FP25332; GUD -AC103; TEF -ACP5299; FRA -CFA112202; MCA -MC8802; FLT -K1260A2X; WIX -WP2015; KNE -LAO467S; COR -49408728; MHL -LAO467S; HEG -E2978LB2
0986628558	Cabin Filter, Activated Carbon+	BMW-64119163328, 64116809933, 64119272641, 64116991537, 64119272642, 64119163329	CMI -EKF320A; VAO -715690; MN -FP25332; GUD -AC103; TEF -ACP5299; FRA -CFA112202; MCA -MC8802; FLT -K1260A2X; WIX -WP2015; KNE -LAO467S; COR -49408728; MHL -LAO467S; HEG -E2978LB2
0986628559	Cabin Filter, Activated Carbon+	AUD-4H0819439	CMI -EKF327A; MHL -LAO667; PRF -AHA362; FRA -CFA11436; VAO -715733; GUD -AC121; FLT -K1318A; KNE -LAO667; COR -49408801; MCA -MC908; MN -FP2641
0986628630	Cabin Filter, Activated Carbon+		PRF -AHA392; LSA -LC26009C; HEG -E2998LB; MHL -LAO888; MN -FP26009; KNE -LAO888
0986628622	Cabin Filter, Activated Carbon+		LSA -LC2450C; PRF -AHA269; MN -FP2450; HEG -E2948LB; KNE -LAO386; MHL -LAO386
0986628560	Cabin Filter, Activated Carbon+	MB-1648300218, A1648300218	MCA -MC7382; MHL -LAO295S; VAO -715544; COR -49408800; MN -FP26462; KNE -LAO295S; PRF -AHA2412

### Filters Cross Reference Chart

Part Number	Product Description	Potential OE Part Number	Potential Comp. Part Number
0986628502	Cabin Filter, Activated Carbon+	DAC-8201153808, 8671018403, 8201370532, 7711426872, 272772835R	VAO -698753; MHL -LAO230; COR -49408487; MN -FP1829; CMI -EKF183; PRF -AHA207
0986628561	Cabin Filter, Activated Carbon+		MHL -LAO387; FRA -CFA10435; MN -FP2733; FIA -PCK8198; WIX -WP9309; CMI -EKF273A; TEF -ACP805; DEP -TSP0325226C; FLT -K1237A; MCA -MP308
0986628608	Cabin Filter, Activated Carbon+	BMW-64316803970	HEG -E1959LB; KNE -LAO248; LSA -LC8430PZC; MN -FP8430; MHL -LAO248
0986628519	Cabin Filter, Activated Carbon+	LEX-87139YZZ53, 8713930100, 87139YZZ38	MHL -LAO119
0986628502	Cabin Filter, Activated Carbon+	REN-8201153808, 8201370532, 272776865R, 7711426872, 272775374R, 7701059997, 272772835R, 7701062227	VAO -698753; MHL -LAO230; COR -49408487; MN -FP1829; CMI -EKF183; PRF -AHA207
0986628561	Cabin Filter, Activated Carbon+	LRG-6G9N180543BA, LR019192, LR019589, 6G9N19N619BA, LR039621, LR056138, VPLFS0488, LR039612, LR000901, LR000899	MHL -LAO387; FRA -CFA10435; MN -FP2733; FIA -PCK8198; WIX -WP9309; CMI -EKF273A; TEF -ACP805; DEP -TSP0325226C; FLT -K1237A; MCA -MP308
0986628565	Cabin Filter, Activated Carbon+pro	BEY-4M0819439B	HEG -E4931LB; MHL -LAO1294; MN -FP31003; KNE -LAO1294
0986628571	Cabin Filter, Activated Carbon+pro	BMW-64115A1BDB7	HEG -E4938LB2; MN -FP230142
0986628567	Cabin Filter, Activated Carbon+pro	MB-A2068351400, 2068351400	MHL -LAO1161; HEG -E5967LB; KNE -LAO1161; MN -FP26023
0986628579	Cabin Filter, Activated Carbon+pro		PRF -AHA300; MN -FP4436
0986628565	Cabin Filter, Activated Carbon+pro	AUD-4M0819439B	HEG -E4931LB; MHL -LAO1294; MN -FP31003; KNE -LAO1294
0986628630	Cabin Filter, Activated Carbon+pro		PRF -AHA392; LSA -LC26009C; HEG -E2998LB; MHL -LAO888; MN -FP26009; KNE -LAO888
0986628580	Cabin Filter, Activated Carbon+pro	BMW-64119382885	KNE -LAO1398; MN -FP30007; MHL -LAO1398
0986628563	Cabin Filter, Activated Carbon+pro		PRF -AHA104; MN -FP2882
0986628600	Cabin Filter, Activated Carbon+pro		KNE -LAO413; HEG -E2954LB03; MHL -LAO413; MN -FP29005
0986628610	Cabin Filter, Activated Carbon+pro	CIT-6447XG, 1616959180, 9821501880	LSA -LC3039C2; MHL -LAO428S; PRF -AHA2612; MN -FP290032; KNE -LAO428S

### Filters Cross Reference Chart

Part Number	Product Description	Potential OE Part Number	Potential Comp. Part Number
0986628591	Cabin Filter, Activated Carbon+pro		HEG -E2980LB; MHL -LAO855; KNE -LAO855; MN -FP28471
0986628630	Cabin Filter, Activated Carbon+pro	VWW-5Q0819669	PRF -AHA392; LSA -LC26009C; HEG -E2998LB; MHL -LAO888; MN -FP26009; KNE -LAO888
0986628622	Cabin Filter, Activated Carbon+pro		LSA -LC2450C; PRF -AHA269; MN -FP2450; HEG -E2948LB; KNE -LAO386; MHL -LAO386
0986628591	Cabin Filter, Activated Carbon+pro	VWW-7P5819631	HEG -E2980LB; MHL -LAO855; KNE -LAO855; MN -FP28471
0986628608	Cabin Filter, Activated Carbon+pro	BMW-64316803970	HEG -E1959LB; KNE -LAO248; LSA -LC8430PZC; MN -FP8430; MHL -LAO248
0986628581	Cabin Filter, Activated Carbon+pro		MN -FP22032
0986628575	Cabin Filter, Activated Carbon+pro		MN -FP34003
F002H24990	Diesel Filter Kit (preliminary And Main Filter)	CHE-J96896403	
9450030116	Diesel Filter Kit (preliminary And Main Filter)	TAE-254709110106	
F002H26625	Diesel Filter Kit (preliminary And Main Filter)	TAE-252709110105, G9450030116, 254709110106	
F002H22012	Fuel Box Filter, Complete		FLG -FS19673
F026402261	Fuel Filter Element	MB-6540920000, A6540920200, 6540920200, A6540920000	FBI -108281; FLG -FK1101; MHL -KX568KIT; BLP -ADU172323; ALC -MD3025; HEG -E488KPD459; MN -PU11001ZKIT; KNE -KX568KIT; AL -ALG7625
F026402533	Fuel Filter Element	CIT-1643624980, 9801366680	UFI -2610400; EOR -1643624980; MN -PU7011Z, PU7010Z; PRF -C533A; MHL -KX420D; WIX -WF8491; FLT -PE8169; HEG -E444KPD308; KNE -KX420D; FRA -C11781ECO
1457070001	Fuel Filter Element	MRU-15411M55KD0	FRA -C10026A; CMI -EFF201; MN -PU723X; WIX -WF8366; PRF -C507A; WGA -FCD0771; FLT -PE982; HEG -E83KP01D140, E83KP02D140, E83KPD140; UFI -60H2O00; KNE -KX208DECO, KX208D; MFR -ELG5322; GUD -M99; MHL -KX208DECO, KX208D
F002H26625	Fuel Filter Element	TAE-252709110105, G9450030116, 254709110106	
F002H24518	Fuel Filter Element	TAE-570107999901	FLG -FF05485

### Filters Cross Reference Chart

Part Number	Product Description	Potential OE Part Number	Potential Comp. Part Number
1457070007	Fuel Filter Element	SKO-1K0127177A, 1K0127434A	KNE -KX178D; HEG -E72KPD107, E72KP02D107; PRF -C505; GUD -M32; WIX -WF8308; CMI -EFF121; MHL -KX178D; UFI -2601400; MN -PU9362X, PU936X; WGA -FCD0600; FLT -PE973; FRA -C9766ECO; MFR -ELG5294
F026402076	Fuel Filter Element	TAE-570309110105	DEP -HDF671; UFI -24ONE01; GUD -MP36; CMI -EFF156; PRF -FCS722; FLT -PP9663; MN -WK85321; CLF -DNW1999, DNW1999G9; FRA -PS10042; WIX -WF8408; CHA -L502606; ACD -XD9320E; AL -ALG2298; MFR -ELG5327; VAO -587536; MAH -KL567; SFM -S10NENR, S10ONENR; FIM -FP5759HWS; MHL -KL567, KL977D; TEN -RN260; HEG -H340WK; BLP -ADL142301; CPF -FP5759HWS, FP5759HSW; KNE -KL567, KL977D
1457070010	Fuel Filter Element	AUD-7L6127434B, 7L6127434C	FLT -PE9736; MHL -KX192D; MN -PU1033X; CMI -EFF152; UFI -2601500; HEG -E84KPD148; PRF -C529; MFR -ELG5416; GUD -M111; FRA -C11045
F002H24496	Fuel Filter Element	MHI-0305DAB00581N	
F002H23441	Fuel Filter Element	HYU-3192226910, 319700P500, 319700P400, 319222B900	
F026402353	Fuel Filter Element		SFM -S6071NE; HEG -E491KPD4892; PRF -C8682; MHL -KX516S
1457070014	Fuel Filter Element	AUD-5Q0127177B, 5Q0127177, 5Q0127177D	CPF -FA6106ECO; PRF -C813; CLF -MG3603; FLT -PE9739; TEN -N346; FIM -FA6106ECO; MHL -KX386, KX492; WIX -WF8477; HEG -E483KP; FRA -C11497ECO; UFI -2603800; MAR -153071760754; MN -PU8028, PU8021; KNE -KX386, KX492; CMI -EFF270D
1457070010	Fuel Filter Element	VWW-7L6127177B, 7L6127434B, 7L6127434C, 7L6127177C, 7L6127401H	FLT -PE9736; MHL -KX192D; MN -PU1033X; CMI -EFF152; UFI -2601500; HEG -E84KPD148; PRF -C529; MFR -ELG5416; GUD -M111; FRA -C11045
F026402248	Fuel Filter Element	AUD-7N0127177C	MN -PU8015; CMI -EFF315D; FLT -PE97310; BLP -ADV182333; WIX -WF8492; FRA -C11193ECO; MFR -ELG5475; EOR -1643628780; UFI -2603200; PRF -C801; COO -FA6064ECO; KNE -KX592; MHL -KX592; TEN -N335; AL -ALG7565
F002H26307	Fuel Filter Element	MHI-942000319, 0305DC0161N	

### Filters Cross Reference Chart

Part Number	Product Description	Potential OE Part Number	Potential Comp. Part Number
1457070014	Fuel Filter Element	SKO-5Q0127177B, 5Q0127177, 5Q0127177D	CPF -FA6106ECO; PRF -C813; CLF -MG3603; FLT -PE9739; TEN -N346; FIM -FA6106ECO; MHL -KX386, KX492; WIX -WF8477; HEG -E483KP; FRA -C11497ECO; UFI -2603800; MAR -153071760754; MN -PU8028, PU8021; KNE -KX386, KX492; CMI -EFF270D
1457070001	Fuel Filter Element	FIA-77362340, 77365902, 77363600, 77365864	FRA -C10026A; CMI -EFF201; MN -PU723X; WIX -WF8366; PRF -C507A; WGA -FCD0771; FLT -PE982; HEG -E83KP01D140, E83KP02D140, E83KPD140; UFI -60H2O00; KNE -KX208DECO, KX208D; MFR -ELG5322; GUD -M99; MHL -KX208DECO, KX208D
F026402360	Fuel Filter Element		PRF -C8242; HEG -E432KPD2502; MFR -JLG5445; MHL -KX397; MN -PU7006; NIP -N1330912; HEB -J1330908; AHK -30ECO083; SFM -S6047NE; JPP -FCECO083; BLP -ADG02370; CMI -EFF294D2
F002H21299	Fuel Filter Element	TAE-886309000012, 886309000119, 253409110117, 254709110118, 279009110111	
F002H24990	Fuel Filter Element	CHE-J96896403	
F026402809	Fuel Filter Element	VWW-7N0127177B, 7N0127177	GUD -M132; FRA -C11193ECO; FLT -PE9737; HEG -E424KPD217; UFI -2602600; PRF -C801; CPF -FA6064ECO; KNE -KX342; CMI -EFF247; ALC -MD691; FIM -FA6064ECO; MN -PU80081, PU8008; MHL -KX342; WIX -WF8470

**Filters Cross Reference Chart**

Part Number	Product Description	Potential OE Part Number	Potential Comp. Part Number
0450902161	Fuel Filter Element	HYU-319111A000	KSS -523FP; AHK -300M000; ACD -FS55; MSF -E710; DEP -FS55, FF0082, EFP201; GUD -E88; SFM -S1710B; BLP -ADN12324; HEB -J1331043; MQP -VFF312, VFF400, VFF467; KNE -KL939, KL72, KL4161, KL2481, KL583, KL248; COO -FIG7038; KAU -1004766001; MGA -FE4001; PBR -AG6123, AG6030; CPF -FT6036; VAO -587001, 587002; CHA -CFF100236, L236, FN38; FLG -FF5675; MGI -ZFETA08000, 08000; WIX -WF8034; MED -4105; NIP -J1331043; LUC -LFPF002; THO -61094; HEG -H112WK, H481WK, H107WK; CLF -MBNA967, MB967, MBNA1561; FLT -PP8311; EOR -E145064, E145004; CRO -6664; TEN -B54; AL -ALG4010, ALG4010AR; FRA -G5857, G10230; LAT -E02; MNC -WK612; MHL -KL939, KL4161, KL2481, KL583, KL248; CMI -EFF005, EFF291; PUR -EP145, F57732, F58063; FIM -FT5386, FT6036; WGA -FCI1630, FCI1101C; HFR -4105; JPP -FCM00S, FC120S; MFR -ELE6005, ELE6015; MN -WK6002, WK6121, WK6031, WK612, WK6032; UFI -3171000, 3194800; KAY -AK100P; PRF -EP145, EP202, EP210; INE -9701699000, 9323266380, 1001569AA, 9701699009, 9200495000, 9200813000, 9200495009
F026402254	Fuel Filter Element	VWW-5Q0127177C	MN -PU8014; HEG -E447KP; PRF -C873; SFM -S6065NE; CLF -MG3621; UFI -2606500; COO -FA6789ECO; MFR -ELG5473; TEN -N631
F026402217	Fuel Filter Element	SKO-3C0127434A	MN -PU825X; MFR -ELG5472; SFM -S6031NE; UFI -2603100
F026402809	Fuel Filter Element	AUD-7N0127177B, 7N0127177	GUD -M132; FRA -C11193ECO; FLT -PE9737; HEG -E424KPD217; UFI -2602600; PRF -C801; CPF -FA6064ECO; KNE -KX342; CMI -EFF247; ALC -MD691; FIM -FA6064ECO; MN -PU80081, PU8008; MHL -KX342; WIX -WF8470
F026402262	Fuel Filter Element	MB-6540920100, 6540920005, A6540920005, A6540920100	MN -PU11002ZKIT; MED -5128; FBI -108353; TEN -N638; PRF -C876; MFR -ELG5493; FRA -C12362; ALC -MD3027; AL -ALG7607; HEG -E458KPD368; AHK -30ECO102; BLP -ADU172322; CPF -FA6796ECO; MHL -KX533KIT; KNE -KX533KIT; CMI -EFF358D
1457070014	Fuel Filter Element	VWW-5Q0127177B, 5Q0127177, 5Q0127177D	CPF -FA6106ECO; PRF -C813; CLF -MG3603; FLT -PE9739; TEN -N346; FIM -FA6106ECO; MHL -KX386, KX492; WIX -WF8477; HEG -E483KP; FRA -C11497ECO; UFI -2603800; MAR -153071760754; MN -PU8028, PU8021; KNE -KX386, KX492; CMI -EFF270D

**Filters Cross Reference Chart**

Part Number	Product Description	Potential OE Part Number	Potential Comp. Part Number
F002H23416	Fuel Filter Element	TOY-233900L041, 233900L010	
F026402254	Fuel Filter Element	SKO-5Q0127177C	MN -PU8014; HEG -E447KP; PRF -C873; SFM -S6065NE; CLF -MG3621; UFI -2606500; COO -FA6789ECO; MFR -ELG5473; TEN -N631
F002H26359	Fuel Filter Element	TAE-278609999822	FLG -FF05540
F026402254	Fuel Filter Element	AUD-5Q0127177C	MN -PU8014; HEG -E447KP; PRF -C873; SFM -S6065NE; CLF -MG3621; UFI -2606500; COO -FA6789ECO; MFR -ELG5473; TEN -N631
1457434511	Fuel Filter Spin-on	HYU-319223A850, 31922C8900, 319223A810, 31970A0900, 319222EA00, 319222E900	HEG -H70WK13; VAO -587725; MFR -ELG5380; CMI -CHY13014, CHY13012; ALC -SP1285; UFI -2444300; WFF -WCF126; KNE -KC226; AMC -KF1466; PRF -CS739; NIP -J1330515; FLT -PP9792; TEN -RN87; FIM -FT5854; WIX -WF8395; CPF -FT5854; AL -ALG20812; BLP -ADG02326; DEP -HDF614; RYC -Z707; SKR -FC2801; MHL -KC226; FRA -PS10235; MN -WK8019, WK8241; GUD -Z531; SFM -S4443NR
F026402362	Fuel Filter Spin-on	HYU-319222W000, 31922A9000	MSF -M712; HEG -H468WK; UFI -2446800; PRF -CS767; KNE -KC504; MHL -KC504; FLT -PP9796, PP9798; WIX -WF8537, WF8545
F026402110	Fuel Filter Spin-on	TOY-23390YZZAB, 2339026160, 2339026140	UFI -2445200; KNE -KC389; FLT -PP8551; GUD -Z544; HEG -H316WK; CMI -EFF251D; FIM -FT6055; MFR -ELG5395; PRF -CS795; ALC -SP1320; TEN -RN511; FRA -P11139; MHL -KC389; AMK -TF1592; MN -WK8028Z
F002H26500	Fuel Filter Spin-on	HYU-319224H001	PUR -387800199
F026402813	Fuel Filter Spin-on	HYU-319224H000, 319224H900, 319224H001	HEG -H70WK13; MFR -ELG5380; CMI -EFF238; GUD -Z578; MN -WK80191, WK8019; MQP -LVFF701; KNE -KC226; BLP -ADG02366; MHL -KC226; PRF -CS739; UNP -GFE5541
F002H23441	Fuel Filter Spin-on	HYU-3192226910, 319700P500, 319700P400, 319222B900	
F026402002	Fuel Filter Spin-on	LRG-MUN000010, WJN101762L	FIM -FT5609; FRA -P9444, P5654; MHL -KC851; PUR -F67737; KNE -KC851; HEG -H70WK15; CMI -EFF303; FLT -PP9402; MN -WK8458; PRF -CS486; UFI -2441700
F002H24518	Fuel Filter Spin-on	TAE-570107999901	FLG -FF05485
F002H21299	Fuel Filter Spin-on	TAE-886309000012, 886309000119, 253409110117, 254709110118, 279009110111	



### Filters Cross Reference Chart

Part Number	Product Description	Potential OE Part Number	Potential Comp. Part Number
1457434106	Fuel Filter Spin-on	FIA-5981936, 5962400, 9936891, 4753103, 60703776, 1902142, 71736113, 8827287, 1909142, 1902138, 1909957, 9941058, 4764725, 5951661, 1930010, 4465121, 4795601	HEG -H70WK02, 1306331; HSS -FF834; KSS -075FS; DEP -FF0056; LUB -FS50, LFF3504; WIX -WF8042, 33472; SVA -92832717, SN327; DON -P550588; MHL -KC17D, KC18; CHA -L113, L111, L112, FP587F; LUC -HDF496; PUR -PER152F, F50086, F57721, F57248, F60152, PER248F; ALC -SP966; PBR -BG1534, BG1527, BG1569; FIM -FT4935A, FP5248, FP4936, FP5352, FP5571, FP5257, FP4935A, FT5364; CRO -5006; BBF -BF587D; MN -WK8422; AL -ALG2253, ALG2051, ALG2441, ALG20514, ALG2259; PRF -CS454, CS197B, CS412B, CS183, CS498, CS701; CPF -FP4935A; FRA -P4183, P4587, P3522, PS9013, P8043; MFR -ELG5204, ELG5265; KAY -AK14DO, AK14D; CAV -7176496; THO -6206; MOK -30789106; GUD -Z108, Z287; FLT -PP8451, PP837; CMI -EFF007; FLG -FF5135, FF214, FF5060; TEN -RN58B; COO -AZF090; UNT -997; APD -LK3578; CLF -DN323; RYC -Z118, Z533; UFI -2435100; MOT -EFG048, EFG9, EFG057, EFG48, EFG035; KNE -KC181, KC17D, KC112, KC51, KC18, KC35, KC43, KC70, KC38
1457434443	Fuel Filter Spin-on	HYU-3192217400	AMK -HF646; WIX -WF8361; CHA -CFF100581; MFR -ELG5366; JPP -FCH18S; NIP -J1330513; MSF -M669; PRF -CS712; MN -WK8182, WK8181; CPF -FSM4199; AL -ALG21786, ALG2178; HEG -H211WK; BLP -ADG02335; FRA -PS9841; PUR -F28921; ALC -SP1243; CMI -CHY13007; FLT -PP9791; MHL -KC111; KNE -KC111
1457434435	Fuel Filter Spin-on	MIT-MB400809, XB433425, RN1213ZA5, MB433425	GUD -Z273; CLF -DN898; WIX -WF8059; FLT -PP853; MFR -ELG5255; AL -ALG2061; FRA -P5173, P4591; DEP -FF0062; KNE -KC82, KC82D; MN -WK815; UFI -2436800; MHL -KC82D; FIM -FT5152; PRF -CS440; AC -XD159; SFM -S7210NR; TEF -PSC994; PBR -BG1559
F002H24509	Fuel Filter Spin-on, Fine Filter	TAE-254709110119	
F002H24509	Fuel Filter Spin-on, Pre-filter	TAE-254709110119	
F002H26307	Fuel Filter, Complete	MHI-942000319, 0305DC0161N	
1457434314	Fuel Filter, Complete		MN -WK8546; TEC -RN216; CMI -EFF078, EFF128; WGA -FCD2076; DEP -6260950; CRO -5072; UFI -24H2O00; GUD -Z550; FLT -PP968; NIP -J1330320; SOF -SOH2ONR; MNC -WK8546; WIX -WF8277; PRF -CS490; MFR -ELG5324; HEG -H159WK; FRA -PS9420WST; KNE -KC140; PBR -WS1001

### Filters Cross Reference Chart

Part Number	Product Description	Potential OE Part Number	Potential Comp. Part Number
1457434314	Fuel Filter, Complete	MRU-15411M86J00, 15410M86J00	MN -WK8546; TEC -RN216; CMI -EFF078, EFF128; WGA -FCD2076; DEP -6260950; CRO -5072; UFI -24H2O00; GUD -Z550; FLT -PP968; NIP -J1330320; SOF -SOH2ONR; MNC -WK8546; WIX -WF8277; PRF -CS490; MFR -ELG5324; HEG -H159WK; FRA -PS9420WST; KNE -KC140; PBR -WS1001
0450905316	Fuel Filter, Gasoline Injection	DAO-25121074	KSS -268FP; GUD -E67; FIM -FT5258, FT5416; MFR -ELE6006, ELE6064; WIX -WF8101; FRA -G5540; CHA -L225; KNE -KL83; CMI -EFF010; TAO -IF15; CRO -6710, 6805, 6806, 6810; UFI -3151500, 3172200; MN -WK512; RYC -Z469, Z578; FLT -PP9052, PP9051, PP905; CLF -MB985; COO -FIG7021; HEG -H110WK, E675L01D157; AL -ALG4564AR, ALG4586, ALG4564Z2; PRF -EP155, EP163; MHL -KL83; PUR -F65217
0450902161	Fuel Filter, Gasoline Injection	REN-226755893R, 8200386495, 7770418696, 7700825495, 6025309779, 15270370579, 0920049500, 7700845973, 8671019073, 6001546326, 6000591768, 7700845961, 8671002344, 8671017076, 7701068107	KSS -523FP; AHK -300M000; ACD -FS55; MSF -E710; DEP -FS55, FF0082, EFP201; GUD -E88; SFM -S1710B; BLP -ADN12324; HEB -J1331043; MQP -VFF312, VFF400, VFF467; KNE -KL939, KL72, KL4161, KL2481, KL583, KL248; COO -FIG7038; KAU -1004766001; MGA -FE4001; PBR -AG6123, AG6030; CPF -FT6036; VAO -587001, 587002; CHA -CFF100236, L236, FN38; FLG -FF5675; MGI -ZFETA08000, 08000; WIX -WF8034; MED -4105; NIP -J1331043; LUC -LFPF002; THO -61094; HEG -H112WK, H481WK, H107WK; CLF -MBNA967, MB967, MBNA1561; FLT -PP8311; EOR -E145064, E145004; CRO -6664; TEN -B54; AL -ALG4010, ALG4010AR; FRA -G5857, G10230; LAT -E02; MNC -WK612; MHL -KL939, KL4161, KL2481, KL583, KL248; CMI -EFF005, EFF291; PUR -EP145, F57732, F58063; FIM -FT5386, FT6036; WGA -FCI1630, FCI1101C; HFR -4105; JPP -FCM00S, FC120S; MFR -ELE6005, ELE6015; MN -WK6002, WK6121, WK6031, WK612, WK6032; UFI -3171000, 3194800; KAY -AK100P; PRF -EP145, EP202, EP210; INE -9701699000, 9323266380, 1001569AA, 9701699009, 9200495000, 9200813000, 9200495009
0450905959	Fuel Filter, Gasoline Injection	AUD-1K0201051C, 1K0201051K	GUD -E144; MFR -ELE6106; CPF -FT5855; FLT -PP8362; KNE -KL572; HEG -H280WK; CMI -EFF172; MN -WK69; TEF -G115; AL -ALG2244; WGA -FCI1304; WIX -WF8386; PRF -EP207; FRA -G10243; MHL -KL572; UFI -3184000

### Filters Cross Reference Chart

Part Number	Product Description	Potential OE Part Number	Potential Comp. Part Number
0450905959	Fuel Filter, Gasoline Injection	VWW-1K0201051C, 1K0201051B, 1K0201051K	GUD -E144; MFR -ELE6106; CPF -FT5855; FLT -PP8362; KNE -KL572; HEG -H280WK; CMI -EFF172; MN -WK69; TEF -GI15; AL -ALG2244; WGA -FCI1304; WIX -WF8386; PRF -EP207; FRA -G10243; MHL -KL572; UFI -3184000
F026403006	Fuel Filter, Gasoline Injection	SKO-6Q0201051C, 6Q0201051J	TEF -GI18; PBR -AG6131; AL -ALG2249, ALG22492; GUD -E158, E119; CLF -MBNA1556; MFR -ELE6101; FIM -FT5785; HEG -H155WK02; PUR -EP204; FLT -PP8364; MHL -KL1563; MN -WK692; PRF -EP204; WIX -WF8317; KNE -KL1563; COO -FIG7108; LAT -ELE6101; TEN -B77; CMI -EFF144; FRA -G10147; SFM -S1833B; UFI -3183300; CRO -6850; ALC -SP2156
0450905318	Fuel Filter, Gasoline Injection	BEY-1J0201511A	GUD -E79; WIX -33521, WF8041; MFR -ELE6013; CLF -MBNA969; WGA -FCI1288; DEP -FF20051; WFF -WZ584; LUB -FN50; AL -ALG20361, ALG2036; FRA -G5870; BAC -BF7670; TEN -B70; RYC -Z584; MHL -KL79; COO -FIG7044; PUR -F65285, F67756; MN -WK7301; CMI -EFF034; TEF -GI10; FIM -FT5380; TAO -IF41; UFI -3171800; HEG -H111WK; PRF -EP192; KNE -KL79; FLT -PP8361; MNC -WK7301; CHA -L237; KSS -419FP
0450905318	Fuel Filter, Gasoline Injection	VWW-1J0201511A	GUD -E79; WIX -33521, WF8041; MFR -ELE6013; CLF -MBNA969; WGA -FCI1288; DEP -FF20051; WFF -WZ584; LUB -FN50; AL -ALG20361, ALG2036; FRA -G5870; BAC -BF7670; TEN -B70; RYC -Z584; MHL -KL79; COO -FIG7044; PUR -F65285, F67756; MN -WK7301; CMI -EFF034; TEF -GI10; FIM -FT5380; TAO -IF41; UFI -3171800; HEG -H111WK; PRF -EP192; KNE -KL79; FLT -PP8361; MNC -WK7301; CHA -L237; KSS -419FP
0450905925	Fuel Filter, Gasoline Injection	VWW-Q0201511, 6Q0201511	MN -WK59X; FLT -PP8363; PRF -EP201; KNE -KL1766D; UFI -3181900; CMI -EFF129; MFR -ELE6063; HEG -H155WK; PUR -F69101; TEF -GI14; WIX -WF8311; FRA -P10089, G9791; MHL -KL1766D; GUD -E119
F026403036	Fuel Filter, Gasoline Injection	FIA-464166841, 46416684, 7083750, 71736106	MOT -8671004346; THO -61102; CPF -FT5351; LUC -LPPF010; KNE -KL238, KL238D; HEG -H115WK; MQP -VFF430; MSF -E105; PRF -EP195; EOR -1643631380; FRA -G7729; CMI -EFF101; HFR -4195; MED -4195; TEN -B29; MFR -ELE6021; LAT -E22; FLT -PS921; MHL -KL238, KL238D; MN -WK510; PBR -AG6070; VAO -587018; WIX -WF8152; CHA -CFF100239, L239; AL -ALG822; UFI -3174000; CLF -MBNA025

### Filters Cross Reference Chart

Part Number	Product Description	Potential OE Part Number	Potential Comp. Part Number
0450905318	Fuel Filter, Gasoline Injection	AUD-1J0201511A	GUD -E79; WIX -33521, WF8041; MFR -ELE6013; CLF -MBNA969; WGA -FCI1288; DEP -FF20051; WFF -WZ584; LUB -FN50; AL -ALG20361, ALG2036; FRA -G5870; BAC -BF7670; TEN -B70; RYC -Z584; MHL -KL79; COO -FIG7044; PUR -F65285, F67756; MN -WK7301; CMI -EFF034; TEF -GI10; FIM -FT5380; TAO -IF41; UFI -3171800; HEG -H111WK; PRF -EP192; KNE -KL79; FLT -PP8361; MNC -WK7301; CHA -L237; KSS -419FP
0450905275	Fuel Filter, Gasoline Injection	MB-0024772601, A0024772701, 0024772801, A0024772801, A0024772601, 0024772701	GUD -E51; MN -WK831; KAY -AK11HO; KNE -KL65; UFI -3158300; FLT -PP836; PUR -F60146; FIM -FT5141; BO -0986SF4020; WGA -FCI1112; PRF -EP189; CHA -L242; PBR -AG6006; WIX -WF8040; KSS -325FP; HEG -H80WK01; AL -ALG20351, ALG2035
0450905264	Fuel Filter, Gasoline Injection		KNE -KL2, FB683; MHL -FB683; TAO -IF1, WT8101; HEG -H80WK01, H80WK07; FRA -G3829; FLT -PP836; UFI -3150000; FIM -FT5141; PBR -AG6004; GUD -E20; KAY -AK11JO; UNP -GFE8383; CHA -L206; TEC -B20; WGA -FCI1287; PRF -EP90C; MFR -ELE6043; SFM -S1500B; PUR -GFE146, F60146; WIX -33161, WF8040; AL -ALG2036; THO -61004; KSS -032FP; MN -WK8307, WK7301; CMI -EFF006
0450905318	Fuel Filter, Gasoline Injection	SKO-1J0201511A	GUD -E79; WIX -33521, WF8041; MFR -ELE6013; CLF -MBNA969; WGA -FCI1288; DEP -FF20051; WFF -WZ584; LUB -FN50; AL -ALG20361, ALG2036; FRA -G5870; BAC -BF7670; TEN -B70; RYC -Z584; MHL -KL79; COO -FIG7044; PUR -F65285, F67756; MN -WK7301; CMI -EFF034; TEF -GI10; FIM -FT5380; TAO -IF41; UFI -3171800; HEG -H111WK; PRF -EP192; KNE -KL79; FLT -PP8361; MNC -WK7301; CHA -L237; KSS -419FP

**Filters Cross Reference Chart**

Part Number	Product Description	Potential OE Part Number	Potential Comp. Part Number
0450902161	Fuel Filter, Gasoline Injection		KSS -523FP; AHK -300M000; ACD -FS55; MSF -E710; DEP -FS55, FF0082, EFP201; GUD -E88; SFM -S1710B; BLP -ADN12324; HEB -J1331043; MQP -VFF312, VFF400, VFF467; KNE -KL939, KL72, KL4161, KL2481, KL583, KL248; COO -FIG7038; KAU -1004766001; MGA -FE4001; PBR -AG6123, AG6030; CPF -FT6036; VAO -587001, 587002; CHA -CFF100236, L236, FN38; FLG -FF5675; MGI -ZFETA08000, 08000; WIX -WF8034; MED -4105; NIP -J1331043; LUC -LFPF002; THO -61094; HEG -H112WK, H481WK, H107WK; CLF -MBNA967, MB967, MBNA1561; FLT -PP8311; EOR -E145064, E145004; CRO -6664; TEN -B54; AL -ALG4010, ALG4010AR; FRA -G5857, G10230; LAT -E02; MNC -WK612; MHL -KL939, KL4161, KL2481, KL583, KL248; CMI -EFF005, EFF291; PUR -EP145, F57732, F58063; FIM -FT5386, FT6036; WGA -FCI1630, FCI1101C; HFR -4105; JPP -FCM00S, FC120S; MFR -ELE6005, ELE6015; MN -WK6002, WK6121, WK6031, WK612, WK6032; UFI -3171000, 3194800; KAY -AK100P; PRF -EP145, EP202, EP210; INE -9701699000, 9323266380, 1001569AA, 9701699009, 9200495000, 9200813000, 9200495009
F026403012	Fuel Filter, Gasoline Injection	AUD-4F0201511C, 4F0201511E	FRA -G10215; FLT -PP8366; CMI -EFF153; HEG -H224WK; WIX -WF8325; MN -WK7204; MFR -ELE6107; GUD -E146; MHL -KL571; UFI -3183100; PRF -EP206
0450905030	Fuel Filter, Gasoline Injection		SVA -SBI104; WIX -33161, WF8040, 33179; MHL -KL2; HEG -H80WK01, H80WK07; LUC -FDB101; PRF -EP90C, EP191; UFI -3150000; PUR -GF146, F60146; PBR -AG6004; DEP -EFP218, FF0021; MNC -WK830; FLG -FF5186; GUD -E51, E20; CRO -6689; AL -ALG2165, ALG2070, ALG20724, ALG2013, ALG2035; CHA -L206; FRA -G3829DP, G3829, G3798; RYC -Z168, Z202; KSS -032FP; TEF -GI011; BLP -ADN12317; EOR -E145069; ALC -SP2003; BO -0986SF4007; MFR -ELE3567, ELE6043; FLT -PP836; UNP -EAC3112; KAY -AK11B, AK11HO; FIM -FT5141; COO -FIG7036, FIG7002; KNE -KL2, KL9, FB683; WFF -WZ168; MN -WK8307, WK830; MQP -LVFF710; BAC -BF1195; CLF -MB957; THO -61004; MOT -EFG107; AMK -NF255L; TEN -B88, B20; CMI -EFF006

**Filters Cross Reference Chart**

Part Number	Product Description	Potential OE Part Number	Potential Comp. Part Number
F026403006	Fuel Filter, Gasoline Injection	AUD-6Q0201051A, 6Q0201051J	TEF -GI18; PBR -AG6131; AL -ALG2249, ALG22492; GUD -E158, E119; CLF -MBNA1556; MFR -ELE6101; FIM -FT5785; HEG -H155WK02; PUR -EP204; FLT -PP8364; MHL -KL1563; MN -WK692; PRF -EP204; WIX -WF8317; KNE -KL1563; COO -FIG7108; LAT -ELE6101; TEN -B77; CMI -EFF144; FRA -G10147; SFM -S1833B; UFI -3183300; CRO -6850; ALC -SP2156
0450905959	Fuel Filter, Gasoline Injection	SKO-1K0201051C, 1K0201051K	GUD -E144; MFR -ELE6106; CPF -FT5855; FLT -PP8362; KNE -KL572; HEG -H280WK; CMI -EFF172; MN -WK69; TEF -GI15; AL -ALG2244; WGA -FCI1304; WIX -WF8386; PRF -EP207; FRA -G10243; MHL -KL572; UFI -3184000
0450905280	Fuel Filter, Gasoline Injection	OPE-90169150, 25055364, 818502, 818512, 818500, 25121974, 25161249, 818513, 818541, 90353562, 818501	PRF -EP139, EP100; AL -ALG2021Z2, ALG2022, ALG2021; ACD -GF516; CHA -L201; GUD -E18; KNE -KL60, KL14; PUR -00610, PFC221, F67221; CRO -6690; RYC -Z200; FLT -PP831; FRA -G6400; KSS -080FP; MFR -ELE6011; WIX -WF8033; TEN -B94; PBR -AG6006; MOT -EFG51, EFG051; MN -WK613; CMI -EFF004, CDH13014; MHL -KL60, KL14; UFI -3150100; UNP -GFE8388; KAY -AK100M, AK100; HEG -H82WK01; CLF -MB950, MB964; FIM -FT5207; COO -FIG7004
F026403006	Fuel Filter, Gasoline Injection	VWW-6Q0201051A, 6Q0201051C, 6Q0201051J	TEF -GI18; PBR -AG6131; AL -ALG2249, ALG22492; GUD -E158, E119; CLF -MBNA1556; MFR -ELE6101; FIM -FT5785; HEG -H155WK02; PUR -EP204; FLT -PP8364; MHL -KL1563; MN -WK692; PRF -EP204; WIX -WF8317; KNE -KL1563; COO -FIG7108; LAT -ELE6101; TEN -B77; CMI -EFF144; FRA -G10147; SFM -S1833B; UFI -3183300; CRO -6850; ALC -SP2156
0450905316	Fuel Filter, Gasoline Injection	OPE-25164444, 818508, 818510, 818514, 818509, 25313359, 808568, 25320277, 818506, 818568, 25161333	KSS -268FP; GUD -E67; FIM -FT5258, FT5416; MFR -ELE6006, ELE6064; WIX -WF8101; FRA -G5540; CHA -L225; KNE -KL83; CMI -EFF010; TAO -IF15; CRO -6710, 6805, 6806, 6810; UFI -3151500, 3172200; MN -WK512; RYC -Z469, Z578; FLT -PP9052, PP9051, PP905; CLF -MB985; COO -FIG7021; HEG -H110WK, E675L01D157; AL -ALG4564AR, ALG4586, ALG4564Z2; PRF -EP155, EP163; MHL -KL83; PUR -F65217

### Filters Cross Reference Chart

Part Number	Product Description	Potential OE Part Number	Potential Comp. Part Number
0450902161	Fuel Filter, Gasoline Injection	HYU-319111A000	KSS -523FP; AHK -300M000; ACD -FS55; MSF -E710; DEP -FS55, FF0082, EFP201; GUD -E88; SFM -S1710B; BLP -ADN12324; HEB -J1331043; MQP -VFF312, VFF400, VFF467; KNE -KL939, KL72, KL4161, KL2481, KL583, KL248; COO -FIG7038; KAU -1004766001; MGA -FE4001; PBR -AG6123, AG6030; CPF -FT6036; VAO -587001, 587002; CHA -CFF100236, L236, FN38; FLG -FF5675; MGI -ZFETA08000, 08000; WIX -WF8034; MED -4105; NIP -J1331043; LUC -LFPF002; THO -61094; HEG -H112WK, H481WK, H107WK; CLF -MBNA967, MB967, MBNA1561; FLT -PP8311; EOR -E145064, E145004; CRO -6664; TEN -B54; AL -ALG4010, ALG4010AR; FRA -G5857, G10230; LAT -E02; MNC -WK612; MHL -KL939, KL4161, KL2481, KL583, KL248; CMI -EFF005, EFF291; PUR -EP145, F57732, F58063; FIM -FT5386, FT6036; WGA -FCI1630, FCI1101C; HFR -4105; JPP -FCM00S, FC120S; MFR -ELE6005, ELE6015; MN -WK6002, WK6121, WK6031, WK612, WK6032; UFI -3171000, 3194800; KAY -AK100P; PRF -EP145, EP202, EP210; INE -9701699000, 9323266380, 1001569AA, 9701699009, 9200495000, 9200813000, 9200495009
F026403756	Fuel Filter, Gasoline Injection	TOY-2330031100	AL -ALG91415; GUD -E155; FIM -FT5866; AMK -TF1590; KNE -KL536; TEN -B47; MHL -KL536; FRA -G10367
F002H23421	Fuel Pipe Filter	MRU-15410M75J01	
0450906374	Fuel Pipe Filter	AUD-1J0127401, 1J0127399A, 1J0127401A, 1J0127401J, 1J0127401B, 2D0127399	FLT -PP9601, PP8391; COO -FSM4129; LUC -LFD119; ACD -XD706, XD9060E; MED -4194; EOR -E148118; VAO -587505, 587500; FIM -FP5359; HEG -H70WK08; FBI -21602; DEP -XD706, HDF515; KSS -421FP; MHL -KL147D, KL147DFV; TEN -RN248; CPF -FP5359, FSM4129; THO -6219, OK219; NAP -NFF2008; PRF -FCS711; BO -0450906329; PBR -AG6031; BLP -ADV182341; MGA -FG2014; MN -WK8534Z, WK8533X; CMI -EFF035; AL -ALG2278, ALG2256, ALG2274; MQP -VFF341; FRA -PS5896; GUD -MP06; WIX -WF8046; CHA -FN85, L142, CFF100142; CLF -DN993; PUR -F67832, F65428; HFR -4194; MAR -152071760800, 71760800; MSF -M391, M391T; KNE -KL147D, KL147DFV, KL2332; MFR -ELG5234; LAT -G19; UFI -3439100, 2439100

### Filters Cross Reference Chart

Part Number	Product Description	Potential OE Part Number	Potential Comp. Part Number
F026402836	Fuel Pipe Filter	MB-A6420905352, 6420906052, A6420906052, 6420905352, A6420903152, 6420903152	HEG -H405WK; FLT -PP8403; BIL -ADU172310; WIX -WF8501; KNE -KL911; PRF -FCS797; MHL -KL911; MN -WK82014; GUD -MP41; CMI -EFF278D; MFR -ELG5462
0450907013	Fuel Pipe Filter	NIS-1640100Q0D, 1640000QAV, 1640100QAA, 164004U105, 16400BC40A, 16400BN700	MFR -ELG5298, ELG5352; FRA -PS10398; WIX -WF8362; CLF -MGC1682, MGC1693; MN -WK9397, WK9396; MSF -F113, F121; MHL -KL631, KL430; CMI -EFF237; DEP -HDF941, HDF907; FLT -PS9802; GUD -G1170, G1150; PRF -FCS748; KNE -KL430; WGA -FCD0910; HEG -H426WK; BLP -ADN12325; UFI -2401300
0450906374	Fuel Pipe Filter	SKO-1J0127401, 1J0127399A, 1J0127401A, 1J0127401B, 2D0127399	FLT -PP9601, PP8391; COO -FSM4129; LUC -LFD119; ACD -XD706, XD9060E; MED -4194; EOR -E148118; VAO -587505, 587500; FIM -FP5359; HEG -H70WK08; FBI -21602; DEP -XD706, HDF515; KSS -421FP; MHL -KL147D, KL147DFV; TEN -RN248; CPF -FP5359, FSM4129; THO -6219, OK219; NAP -NFF2008; PRF -FCS711; BO -0450906329; PBR -AG6031; BLP -ADV182341; MGA -FG2014; MN -WK8534Z, WK8533X; CMI -EFF035; AL -ALG2278, ALG2256, ALG2274; MQP -VFF341; FRA -PS5896; GUD -MP06; WIX -WF8046; CHA -FN85, L142, CFF100142; CLF -DN993; PUR -F67832, F65428; HFR -4194; MAR -152071760800, 71760800; MSF -M391, M391T; KNE -KL147D, KL147DFV, KL2332; MFR -ELG5234; LAT -G19; UFI -3439100, 2439100
F026402085	Fuel Pipe Filter	BMW-13327788700, 7793672, 7802939, 13327793672	KSS -902FP; PUR -F79099; MFR -ELG5301; PRF -FCS724; MQP -VFF519; DEP -HDF558; MED -4716; COO -FSM4235, FP5779, FP5918; BLP -ADB112301; SFM -S1851B, S1852B; GUD -E149; CHA -L424; CRO -5092; MN -WK5001; GUR -GFI15500; FRA -P10089; UFI -3185200, 3185240, 3185100, 3181700; TEN -GS519; MHL -KL579, KL579D; WIX -WF8496, WF8365; ALC -SP1267; MYL -3143230001; AL -ALG2348, ALG2148; HEG -H209WK, H247WK01, H337WK, H247WK; CLF -MG1615; FLT -PP9762, PP9765; PBR -AG6124; HFR -7690716
F002R20002	Fuel Pipe Filter	TAE-279018130102, 279109110101, 279109110102, G279018130103	



**Filters Cross Reference Chart**

Part Number	Product Description	Potential OE Part Number	Potential Comp. Part Number
F026402257	Fuel Pipe Filter	MBM-13328515903	SFM -S9261B; PRF -FCS854; UFI -3192601; TEN -RN623; FRA -P11889; DEP -HDF696; COO -FP6147; KNE -KL983D; MN -WK5015, WK5015Z; HEG -H423WK; MQP -LVFF774; FLT -PP9766; MHL -KL983D; MFR -ELG5461
F026402106	Fuel Pipe Filter	BMW-13327823413, 1332782341301, 13328584874	MHL -KL763D; PRF -FCS805; CMI -EFF229; HEG -H339WK; UFI -3185700, 3185701; MN -WK5010Z, WK5010; FRA -PS11213; WIX -WF8446; GUD -E192; FLT -PP9763
F026402846	Fuel Pipe Filter	LRG-LR001313	CLF -MGC1697; MN -WK12001; FRA -PS10288; TEN -RN298; AMC -MF4443; MHL -KL581; CMI -EFF192; DEP -HDF632; FIM -FP5799; WIX -WF8397; TEF -FCI779; ALC -FF077; FLT -PS9742; LUC -LFDF207; HEG -H346WK; BLP -ADC42361; MFR -ELG5365; PRF -FCS604; KNE -KL581; AL -ALG40222; UFI -2415600; GUD -G1149
F002H23423	Fuel Pipe Filter	MRU-15410M79F91, 15410M53M00, 15410M79F10, 15410M79F01	
F026402103	Fuel Pipe Filter	MB-A6420901852, 6420920301, A6420902052, 6420901852, 6420901752, 6420902052, A6420920301, A6420901752	GUD -MP52; CMI -EFF250D; FLT -PP84110; PRF -FCS785; HEG -H331WK; UFI -2411100; FRA -P11044; MN -WK8016X; WIX -WF8467; KNE -KL490D
F026402824	Fuel Pipe Filter	MBM-13328572522	TEN -RN611; CPF -FP5932; UFI -3195200, 3192601; WIX -WF8483; PRF -FCS828, FCS783; FIM -FP5932; FRA -P11039; EOR -1643625280; MN -WK50051Z; MFR -ELG5450X; HEG -H351WK; ALC -SP1407; CMI -EFF260; AL -ALG20383; GUD -E178; KNE -KL736, KL7361D; DEP -HDF658; FLT -PP9764; CLF -MG1680; MHL -KL736, KL7361D
0986450509	Fuel Pipe Filter	SKO-057127435D, 057127401A	HEG -H126WK; GUD -MP11; AL -ALG2257; MN -WK8231; FIM -FT5468; FLT -PP8394; PUR -F67902; MFR -ELG5256; PRF -FCS706; CMI -EFF050; UFI -2442400; WGA -FCD20681; WIX -WF8199; KNE -KL154; FRA -P8916
F026402839	Fuel Pipe Filter	MB-6510901652, A6510902852, A6510901652, 6510902852	PRF -FCS932; CMI -EFF279D; KNE -KL913; FLT -PP8409; GUD -MP53; WIX -WF8472; HEG -H406WK; MHL -KL913; UFI -2415100; MN -WK82017

**Filters Cross Reference Chart**

Part Number	Product Description	Potential OE Part Number	Potential Comp. Part Number
F026402076	Fuel Pipe Filter	TAE-570309110105	DEP -HDF671; UFI -24ONE01; GUD -MP36; CMI -EFF156; PRF -FCS722; FLT -PP9663; MN -WK85321; CLF -DNW1999, DNW1999G9; FRA -PS10042; WIX -WF8408; CHA -L502606; ACD -XD9320E; AL -ALG2298; MFR -ELG5327; VAO -587536; MAH -KL567; SFM -S10NENR, S100NENR; FIM -FP5759HWS; MHL -KL567, KL977D; TEN -RN260; HEG -H340WK; BLP -ADL142301; CPF -FP5759HWS, FP5759HSW; KNE -KL567, KL977D
F026402358	Fuel Pipe Filter	BMW-8591019, 13328582272, 8582272, 13328591018, 8591018, 8582008, 13328591019, 13328582008	MN -WK5017; CMI -EFF360D; MQP -LVFF833; KNE -KL8727; HEG -H600WK; AL -ALG24091; MHL -KL8727
F002H23416	Fuel Pipe Filter	TOY-233900L041, 233900L010	
0450906500	Fuel Pipe Filter	VWW-6Q0127401F, 6RF127401A, 6Q0127400F	UFI -2443700, 2443701; FLT -PP986; CPF -FP5778; DEP -HDF575; GUD -MP22; HEG -H281WK; WIX -WF8379; AL -ALG2087; FRA -P10100; FBI -26340; ALC -SP1292; EOR -E148094; LAT -G59; MQP -VFF539; MHL -KL494; CLF -DN1958; LUC -LFDF159; TPR -110862; VAO -587510; CMI -EFF157; VIE -V101638; MFR -ELG5318, ELG5218; MED -4843; PRF -FCS725; MN -WK8232; KNE -KL494; BLP -ADV182302; TEN -RN263; SFM -S4437NR, S1437NR; MSF -M518; PBR -AG6127
F026402824	Fuel Pipe Filter	BMW-13328511052, 8572518, 13327822497, 13328511053, G13327822497, 13328572522, 8572522, 13328572518	TEN -RN611; CPF -FP5932; UFI -3195200, 3192601; WIX -WF8483; PRF -FCS828, FCS783; FIM -FP5932; FRA -P11039; EOR -1643625280; MN -WK50051Z; MFR -ELG5450X; HEG -H351WK; ALC -SP1407; CMI -EFF260; AL -ALG20383; GUD -E178; KNE -KL736, KL7361D; DEP -HDF658; FLT -PP9764; CLF -MG1680; MHL -KL736, KL7361D
F026402257	Fuel Pipe Filter	BMW-13328597828, 13328515903, 13328584868, 13328514121	SFM -S9261B; PRF -FCS854; UFI -3192601; TEN -RN623; FRA -P11889; DEP -HDF696; COO -FP6147; KNE -KL983D; MN -WK5015, WK5015Z; HEG -H423WK; MQP -LVFF774; FLT -PP9766; MHL -KL983D; MFR -ELG5461
F026402095	Fuel Pipe Filter	LRG-WJN000080	WIX -WF8411; COO -FSM4291; ALC -SP1317; MN -WK522; FRA -910441, P10441; GUD -E174; MFR -ELG5361; FLT -PP9692; UFI -3192500; PRF -CP103; CMI -EFF210; MAH -KL232; HEG -H449WK; KNE -KL232; AL -ALG2130; MHL -KL232

### Filters Cross Reference Chart

Part Number	Product Description	Potential OE Part Number	Potential Comp. Part Number
1457434437	Fuel Pipe Filter	MB-A6460920301, A6460920501, 6460920001, 6460920301, A6460920001, 6460920501	FLT -PP9892, PP8406, PP8416; BLP -ADC42358; KNE -KL313; PRF -CS499; HEG -H140WK01, H140WK; CLF -DN1908; MFR -ELG5296; SFM -S2320NR; MHL -KL313; CMI -EFF124; UFI -2443600; FRA -P9635; GUD -MP12; MN -WK820, WK8201; AL -ALG22458, ALG22451; WIX -WF8509, WF8309
0450906457	Fuel Pipe Filter	BMW-7811227, 13327811227, 13327788700, 13327811401, 7811401	KNE -KL1694D; PRF -FCS783; CMI -EFF282D; UFI -3185100; FLT -PP9762; CPF -FP5932; FIM -FP5932; DEP -HDF558; AL -ALG21482; HEG -H209WK, H247WK01; WIX -WF8365; GUD -E184; MHL -KL1694D, KL1693D; CLF -MG1661; PUR -F79099, FCS724; MN -WK5002X; FRA -P10089, P11681, P11039
F026402076	Fuel Pipe Filter	FIA-77363657, 71773197, 51929061	DEP -HDF671; UFI -24ONE01; GUD -MP36; CMI -EFF156; PRF -FCS722; FLT -PP9663; MN -WK85321; CLF -DNW1999, DNW1999G9; FRA -PS10042; WIX -WF8408; CHA -L502606; ACD -XD9320E; AL -ALG2298; MFR -ELG5327; VAO -587536; MAH -KL567; SFM -S10NENR, S10NENR; FIM -FP5759HWS; MHL -KL567, KL977D; TEN -RN260; HEG -H340WK; BLP -ADL142301; CPF -FP5759HWS, FP5759HSW; KNE -KL567, KL977D
0450906458	Fuel Pipe Filter	AUD-057127435E, 057127435C	HEG -H444WK; CMI -EFF173; WIX -WF8441; MHL -KL447; SFM -S4002NR; FLT -PP9863; PRF -FCS942; KNE -KL447; MN -WK1136; DEP -HDF549; UFI -2400200
0450906500	Fuel Pipe Filter	SKO-6Q0127401F, 6Q0127400F	UFI -2443700, 2443701; FLT -PP986; CPF -FP5778; DEP -HDF575; GUD -MP22; HEG -H281WK; WIX -WF8379; AL -ALG2087; FRA -P10100; FBI -26340; ALC -SP1292; EOR -E148094; LAT -G59; MQP -VFF539; MHL -KL494; CLF -DN1958; LUC -LFDF159; TPR -110862; VAO -587510; CMI -EFF157; VIE -V101638; MFR -ELG5318, ELG5218; MED -4843; PRF -FCS725; MN -WK8232; KNE -KL494; BLP -ADV182302; TEN -RN263; SFM -S4437NR, S1437NR; MSF -M518; PBR -AG6127

### Filters Cross Reference Chart

Part Number	Product Description	Potential OE Part Number	Potential Comp. Part Number
0450904058	Fuel Pipe Filter	BMW-1277497, 13321277481, 13321278272, 5490862, 13321278282, 133212782723, 13321277497, 13311255179	PBR -BF1001, BF1003; PRF -EP58, GF20, EP103, EP20, GF12, EP57; GUO -GF20, GF12; CHA -L104, L101; BO -0986SF4048; FIM -FT5082CS, FT48741, FT4648, FT4874; KAY -AK0168; MOT -EFG21, EFG021; DON -FFP550012, P550094, P550012; AMK -NF259, NF252; ACD -FS1B; MNC -WK312; UFI -3100900, 3100300, 3174100, 3101400, 3100100; CMI -EFF012; MFI -MP482; FRA -G4164, G20, CR121; MHL -KL13, KL110F, KL12; MN -WK312, WK31210; RYC -Z14K, Z14, Z91, Z15; VIC -FC210; COO -AZF048, Z947, Z294MHB, Z29A, Z507, Z5072, Z29; FLG -FF149, FF238, FF5480; SVA -93076442, SB230, 93076342; KNE -KL13, KL110F, KL630F, KL13SB, KL130F, KL12; FLT -PS842; GUD -Z295, Z2923; PUR -GF680F, F27332, F50154, GF20, F57243, GF68S, PFC1M, GF12, F57608, F20001M, F21111, F20005M, GF68, F20117, F20005, F21124; HEG -1511, H101WK, H132WK, O1511; DEP -FF0019, FF0015, FF0012, FF0010, FF0009, FF0014; WIX -WF8130; APD -LK71700, LK3684; AL -ALG14MP, ALG300, ALG516G, ALG312, ALG516MP, ALG306; CLF -MB001, MB006, MB6, MBNA006, MBNA001, MB1; WFF -WZ14, WZ15; THO -71002; ALC -FF009, FF010; KSS -074FP; TEN -B7, KLF2; CRO -710, 703, 700K, 701, 700, 703K
F026402808	Fuel Pipe Filter	AUD-4G0127400C, 8W0127399A	MN -WK6008; ALC -SP1369; FIM -FP6074; WIX -WF8463; HEG -H355WK; PRF -FCS809; FLT -PP9913; BLP -ADV182304; KNE -KL915; MHL -KL915; GUD -E177; FRA -P11237
F026402846	Fuel Pipe Filter	JAG-AJ811141	CLF -MGC1697; MN -WK12001; FRA -PS10288; TEN -RN298; AMC -MF4443; MHL -KL581; CMI -EFF192; DEP -HDF632; FIM -FP5799; WIX -WF8397; TEF -FCI779; ALC -FF077; FLT -PS9742; LUC -LFDF207; HEG -H346WK; BLP -ADC42361; MFR -ELG5365; PRF -FCS604; KNE -KL581; AL -ALG40222; UFI -2415600; GUD -G1149
9451037404	Fuel Pre-filter Element	TAE-9451037404, 252709110104	

**Filters Cross Reference Chart**

Part Number	Product Description	Potential OE Part Number	Potential Comp. Part Number
1457434293	Fuel Pre-filter, Complete	FIA-9951033, 46471844, 9947995	MN -WK8455, WK8538, WK854; COO -FSM4123; FLT -PP954, PP9402, PP9401; HEG -H117WK, H70WK, H121WK; DEP -HDF570; KNE -KC103, KC25; MFR -ELG5254, ELG5253; FIM -FP5425, FP5534, FT5291; WGA -FCD2293; FRA -PS8745, P5655; WIX -WF8179; CMI -EFF072; PBR -BG1585; AL -ALG2266, ALG20581, ALG2258, ALG2058, ALG20566, AL20562; ALC -SP1249; PRF -CS264, CS486; MHL -KC103; UFI -2435002, 2440800, 2435001, 2435500, 2435101; EOR -E148129; MSF -M408; CHA -L254606, L123; KSS -382FS; CLF -DN877; LUB -FS113
F002H24311	Oil Filter Element	MRU-16510M82713, 16510M73080, 16510M73013, 16510M82703, 16510M73010	
F026407344	Oil Filter Element	AUD-07C115562E	MHL -OX557D; PRF -L1110; KNE -OX557D; WIX -57562; MSF -L239; MN -HU8010Z; HEG -E314H01D58
F026407067	Oil Filter Element	FIA-55238304, 55197218, 73504027	KNE -OX418D, OX418; AMK -SO920; MFR -ELH4351; CPF -FA5766ECO; COO -G1677; FLT -OE682; WIX -WL7429; PBR -AC8083; PRF -L377; SFM -S5031PE; LAT -ELH4351; AL -ALO8177; FRA -CH10047ECO; CMI -EOF192; BLP -ADK82106; SCT -SH4797; GUR -GFO7127; MN -HU7127X; GUD -M147; ALC -MD547; HEG -E107HD166; UFI -2503100, 2325031; MHL -OX418D; TEN -OLO10047E
F026407205	Oil Filter Element	BMW-8575211, 11428575211	KNE -OX8131D, OX8132D; HEG -E362HD313; MN -HU60141Z, HU6014Z; SFM -S5188PE; PRF -L1049; CPF -FA4766ECO; FRA -CH11913ECO; TEN -OP1028; GUD -M176; WIX -WL7531A; MHL -OX8131DECO, OX8131D, OX8132D; FLT -OE6727A; UFI -2518800
F002H23550	Oil Filter Element	MRU-16510M68K10, 16510M68K00	
F002H60003	Oil Filter Element	TAE-253418130129	
F026407319	Oil Filter Element	MB-2751800009, A2751840025, 2751840025, A2751800009	WIX -WL7425; BLP -ADU172105; MCA -OF080; CHA -XE553606, XE553; FRA -CH11792ECO, CH10682ECO; CMI -EOF215; KNE -OX1111D, OX383DECO, OX1111DECO, OX383D; GUD -M36; MHL -OX1111D, OX383DECO, OX1111DECO, OX383D; ACD -AC6296E, AC6210E; HEG -E17H01D50; QHZ -WL7425; KSS -50013990, 990OX; TEN -OP406; CPF -FA6802ECO, FA5968ECO; AHK -10ECO088; PRF -L1078, L420; ALC -MD471; JPP -FOECO088; MYL -0143220001; PUR -L35544; MQP -LVFL855; MN -HU7213X; FBI -221697; FLT -OE6772

**Filters Cross Reference Chart**

Part Number	Product Description	Potential OE Part Number	Potential Comp. Part Number
F026407204	Oil Filter Element	MBM-11428570590	WIX -WL7522; TEF -PEL728; FLT -OE6726; CPF -FA6146ECO; PRF -L1045; FRA -CH11885ECO; MN -HU6015ZKIT; UFI -2518500; KNE -OX8151D; MHL -OX815DECO, OX8151D; MFR -ELH4464; HEG -E833HD321
F026407023	Oil Filter Element	VWW-03L115562, 03L115466	TEF -PEL677; CMI -EOF236; MFR -ELH4407; SFM -S5106PE; FIM -FA5974ECO; MN -HU7008Z; UFI -2510600; JPP -FOECO098; ALC -MD679; GUD -M118; CLF -ML4509; MHL -OX388D; WIX -WL7476; SCT -SH4049P; FRA -CH10759ECO; PRF -L418; FLT -OE688; CPF -FA5974ECO; HEG -E115HD208, E115H01D208; BLP -ADV182110; ACD -AC6309E
F026407122	Oil Filter Element	POR-95810722220	MFR -ELH4446; MHL -OX420D; PRF -L988; HEG -E816HD236; UFI -2514100; FRA -CH11490ECO; MN -HU8005Z; GUD -M133; WIX -WL7501; CMI -EOF263; FLT -OE6507
F026407278	Oil Filter Element	AUD-06L115466, 06L115562B, 06L115562, 06K115562, 06K115466, 06L115466C	KSS -4598OX; CPF -FA6107ECO; MQP -LVFL792; GUD -M143; MN -HU6013Z; TEF -PEL680; HEG -E358H, E358HD246; MPC -61206; FLT -OE6882; MFR -ELH4439; SFM -S5176PE1, S5153PE; MHL -OX1217D, OX835DECO, OX1107D, OX835D, OX1107DECO; UFI -2515300; KNE -OX1217D, OX835DECO, OX1107D, OX835D, OX1107DECO; BBF -P40010; FRA -CH11498ECO; WIX -WL7507; ALC -MD745; PRF -L980; TEN -OP1011; AHK -10ECO124; JPP -FOECO124; BLP -ADV182119; MYL -1003220022; MSF -L128; CLF -ML4536; MED -14164
F026407320	Oil Filter Element	POR-95810722210	MHL -OX983D; SOG -L1071; SFM -S5089PE; FRA -CH11242ECO; MQP -LVFL831; KNE -OX983D; HEG -E136HD428; BLP -ADV182123; MFR -ELH4501; ALC -MD713; MN -HU8009Z; AL -ALO8714; CMI -EOF281; PRF -L1071; UFI -2508900
F002H23434	Oil Filter Element	TAE-279018130104, 279018130106, 279018130105, G279018130106	
F002H23435	Oil Filter Element	HYU-263102A002, 263102A500, 263102A501	
F026407228	Oil Filter Element	BMW-11427635802, 11427618462, 11427634292	MQP -LVFL828; CPF -FA6128ECO; PRF -L993; MN -HU8002Y; UFI -2514600; TEN -OP1024; TEF -PEL806; MED -14155; FRA -CH11427ECO; GUF -GFO174; SFM -S5146PE; MFR -ELH4456
F026407238	Oil Filter Element	MB-A6541840025, 6541801100, 6541840025, A6541801100	MFR -ELH4490; MN -HU6020Z; FLG -LF17805; PRF -L1107; FLT -OE6776A; HEG -E866HD367; WIX -WL7553A; KNE -OX8236D; MHL -OX8236D

### Filters Cross Reference Chart

Part Number	Product Description	Potential OE Part Number	Potential Comp. Part Number
F026407094	Oil Filter Element	BMW-11427808443	FLT -OE6723; KNE -OX560D; FRA -CH11150ECO; FIM -FA5988ECO; UFI -2509600; PRF -L444; SCT -SH4055P; JPP -FOECO101; GUD -M109, M110; ALC -MD677; AL -ALO8701; SFM -S5096PE; ACD -AC6037E; HEG -E125HD209; MN -HU7203X; MFR -ELH4415; MHL -OX560D; WIX -WL7469; CMI -EOF225
F026407155	Oil Filter Element	LRG-LR013148	UFI -2515200; GUD -M108; FIM -FA5987ECO; MFR -ELH4448; WIX -WL7490; KNE -OX776D; CMI -EOF229; MHL -OX776DECO, OX776D; TEN -OP416; FLT -OE6673; PRF -L442; TEF -PEL724; FRA -CH11015ECO; CLF -ML4537; HEG -E832HD317; MN -HU826X
F026407155	Oil Filter Element	JAG-JDE8751	UFI -2515200; GUD -M108; FIM -FA5987ECO; MFR -ELH4448; WIX -WL7490; KNE -OX776D; CMI -EOF229; MHL -OX776DECO, OX776D; TEN -OP416; FLT -OE6673; PRF -L442; TEF -PEL724; FRA -CH11015ECO; CLF -ML4537; HEG -E832HD317; MN -HU826X
F002H24988	Oil Filter Element	TOY-0415231110	
F026407178	Oil Filter Element	BMW-11427618461, 11427634291	PRF -L993; GUD -M146; MN -HU8002XKIT; FLT -OE6499; UFI -2517900; FRA -CH11427ECO; HEG -E819HD239
F026407072	Oil Filter Element	BMW-11427807177, 11427805707	WIX -WL7474, WL7474A; FLT -OE6722; CPF -FA5962ECO; UFI -2508400; HEG -E122HD187; MHL -OX3614D; FRA -CH10660ECO; MFR -ELH4425; CMI -EOF219; FIM -FA5962ECO; PRF -L407; GUD -M83; SFM -S5084PE; MN -HU7215X
1457429619	Oil Filter Element	SKO-074115562	PBR -AC8002; MN -HU7261X, HU7262X; FLT -OE6401; HEG -E15326, E154HD48, D48E15326, E154H; LUB -LC124, P856; UFI -2501100; WIX -WL7008, 57210; MFI -MU1178, MO1178; GUD -M13; MPC -64804; FLG -LF16176; DEP -FX0114; ATU -P00009; PRF -L291; MHL -OX143DECO, OX143, OX143D; LAT -ELH4216; CPF -FA5412ECO; CHA -XE505; CLF -ML030; THO -5505; FIM -FA5412, FA5412ECO; ALC -MD355; ACD -AC6212E; SFM -S5011PE; KNE -OX143DOEKO, OX143D; COO -G1399; TEN -OP204; FRA -CH8530ECO, CH8530; CRO -1047; WGA -W0E610; MFR -ELH4216; PUR -L45308, L37735; CMI -EOF044

### Filters Cross Reference Chart

Part Number	Product Description	Potential OE Part Number	Potential Comp. Part Number
F026407278	Oil Filter Element	VWW-06L115466, 06L115562B, 06L115562, 06K115562, 06K115466, 06L115466C	KSS -4598OX; CPF -FA6107ECO; MQP -LVFL792; GUD -M143; MN -HU6013Z; TEF -PEL680; HEG -E358H, E358HD246; MPC -61206; FLT -OE6882; MFR -ELH4439; SFM -S5176PE1, S5153PE; MHL -OX1217D, OX835DECO, OX1107D, OX835D, OX1107DECO; UFI -2515300; KNE -OX1217D, OX835DECO, OX1107D, OX835D, OX1107DECO; BBF -P40010; FRA -CH11498ECO; WIX -WL7507; ALC -MD745; PRF -L980; TEN -OP1011; AHK -10ECO124; JPP -FOECO124; BLP -ADV182119; MYL -1003220022; MSF -L128; CLF -ML4536; MED -14164
F026407014	Oil Filter Element	NIS-1520900Q0A	FIM -FA5773ECO; FLT -OE6662; NIP -N1311037; BLP -ADN12127; UFI -2509400; WIX -WL7424; MHL -OX441DECO, OX441D, OX441; COO -G1669; HEG -E112HD180; CMI -EOF202; PBR -AC8086; FRA -CH11208ECO, CH10076ECO; ALC -MD631; TEN -OP281, TENOP281; HEB -J1311031; GUD -M107; KNE -OX441D; MN -HU618X; MFR -ELH4358; PRF -PRFFA5773ECO, L360, L470
F002H20264	Oil Filter Element	TAE-279018130101, 279018130102, G279018130103	FLG -LF16080
F026407277	Oil Filter Element	MBM-11428593186	MHL -OX1238D; PRF -L1133; KNE -OX1238D; MN -HU6012ZKIT; SFM -S5211PE; FLT -OE6729; UFI -2521100; HEG -E951HD497; TEF -PEL699
1457429192	Oil Filter Element	SKO-071115562A, 071115562C	CHA -XE525; SOP -OX188D; ACD -AC6206E; MN -HU7197X; FIM -FA5618ECO, FA5620ECO; MHL -OX188D, OX188DECO; TEF -PEL111; ALC -MD437; WGA -W0E630; HEB -J1315024; SFM -S5023PE; PUR -L38113; CMI -EOF087; CPF -FA5618AECO; CRO -2232, 2233; AMK -MO438; MFR -ELH4307; LAT -ELH4307; MPC -64806; BLP -ADA102101; MNC -HU7197X; FLT -OE6501; NIP -J1315028; HEG -E19HD83; FRA -CH9461, CH9461ECO, CH9463ECO, CH9463AECO; PBR -AC8043, AC8041; DEP -FX20036; UFI -2502300; PRF -L267D, L267A, L267, L263A; KSS -505OX; KNE -OX188DOEKO, OX188D; AL -ALO8119; COO -G1471, G1473; TEN -OP222, OP269, OP224, OP259; GUD -M29; WIX -WL7296; CLF -ML1705, ML1704



### Filters Cross Reference Chart

Part Number	Product Description	Potential OE Part Number	Potential Comp. Part Number
1457429194	Oil Filter Element	SKO-03D198819, 03D198819C, 03D198819A	MHL -OX360DECO, OX360D; CPF -FA5640ECO; MFI -MU1215; MPC -64803; PRF -L339; FRA -CH9530ECO; ATU -P00140; PBR -AC8047; TEN -OP233; WIX -WL7318; PUR -L18340; KNE -OX360D; THO -5536; CHA -XE527; ACD -AC6191E; COO -G1538, AG1538; LAT -ELH4322; CMI -EOF143; ALC -MD427; HEG -E37HD84; FIM -FA5640ECO; DEP -FX20037; SFM -S5029PE; CLF -ML060; UFI -2502900; FLT -OE671; MN -HU710X; KSS -364OX; MFR -ELH4322
F026407264	Oil Filter Element	BMW-11427826799, 11428583898	MN -HU6022Z; PRF -L1126; TEF -PEL700; MQP -LVFL845; SFM -S5148PE; BLP -ADB112117; MHL -OX1146D; UFI -2514800; JPP -FOECO026; HEG -E859HD352
F026407122	Oil Filter Element	AUD-059198405	MFR -ELH4446; MHL -OX420D; PRF -L988; HEG -E816HD236; UFI -2514100; FRA -CH11490ECO; MN -HU8005Z; GUD -M133; WIX -WL7501; CMI -EOF263; FLT -OE6507
F002H23467	Oil Filter Element	HON-15400PH1F03, 15400PR3014, 15400RAFT01, 15400PLC003, 15400PLC004, 15400RTA004, 15400PMET01, 15400RTA003, 15400P3RE01	
F026407204	Oil Filter Element	BMW-11428570590, 11428575210	WIX -WL7522; TEF -PEL728; FLT -OE6726; CPF -FA6146ECO; PRF -L1045; FRA -CH11885ECO; MN -HU6015ZKIT; UFI -2518500; KNE -OX8151D; MHL -OX815DECO, OX8151D; MFR -ELH4464; HEG -E833HD321
F026407275	Oil Filter Element	JAG-JDE37128	MHL -OX1138D; PRF -L994; FLT -OE6675; SOG -L994; TEF -PEL698; MN -HU6024Z; HEG -E867HD370

### Filters Cross Reference Chart

Part Number	Product Description	Potential OE Part Number	Potential Comp. Part Number
1457429122	Oil Filter Element	MB-A1041840225, A1041800709, A1041840425, A1041840325, 1041800709, A1041800109, A1041840825, 1041840225, 1041840325, 1041840425, 1041800109, 1041840825	COO -G1268; ACD -AC6213E; CHA -X122, XE506; DEP -FX0182, FX0156; NIP -J1310400; MRO -8671002320; SFM -S8280PO; HEG -E142HD21, D21E142H, E142H; KSS -164OC, 227OX; RYC -R2596P; LUB -LC142, LC112, P843; TEF -PEL721; LAT -ELH4201; AMK -SO803; AL -ALO8111; CLF -ML493; FIM -FA5228; THO -5225, D225; FRA -CH6848; PRF -L247, L313; MN -H7271X, HU7271X; MHL -OX133, OX105, OX105D, OX133D, OX104, OX133DECO; FLT -OE6403, OM599; KNE -OX133DOEKO, OX105D, OX133D; SVA -SO989; TEN -OP828, OP214; MFR -ELH4201; UFI -2516200, 2558600; CRO -1033; WIX -85434, WL7304, WL7060; CPF -FA5228; PBR -AC8008, AC3356; PUR -L37858, L44757; WGA -WOE430; GUD -G1029; CMI -EOF017; DON -P550521; MNC -H7271X; ALC -MD281, MD341; MPC -64881; HEB -J1310400; MFI -MO1174, MU1191, MO1191
F002H24495	Oil Filter Element	TAE-570518130102	
F026407313	Oil Filter Element	AUD-079198405D, 079115561J	PRF -L1070; MN -HU7024Z; KNE -OX1123D; AL -ALO8758; SFM -S5090PE; MHL -OX1123D; ALC -MD841; BLP -ADV182115; MQP -LVFL814; HEG -E861HD413; UFI -2509000; FRA -CH11791ECO
F002H23523	Oil Filter Element	MRU-16510M65L10, 16510M65L00	
F026407132	Oil Filter Element	MB-A2711840525, A2711800509, 2711840425, 2711800509, A2711840425, 2711840525, 2711840325, 2711800309, A2711840325, A2711800309, 2711800409, A2711740425, 2711740425, A2711800409	FRA -CH11246ECO; FLT -OE64010; GUD -M119; HEG -E207HD221; MN -HU514Y; WIX -WL7500; UFI -2515500; PRF -L474; CMI -EOF283; MHL -OX1835D
F026407090	Oil Filter Element	LEX-415231060, 04152YZZA5, 041520R010, 0415231080, 0415238010, 0415231060, 415231080, 04152YZZA3, 4152YZZA5	PRF -L385; SCT -SH4039P; FRA -CH10158ECO; KNE -OX413D2, OX413D1; MHL -OX413D2, OX413D1; AMK -TO142; HEG -E814HD191; BLP -ADT32118; NIP -J1312022; CMI -CTY11172; MN -HU7009Z; FLT -OE6854, OE685; SFM -S5077PE; HEB -J1312020; AL -ALO8155; MFR -ELH4382; UFI -2507700; CPF -FA5842ECO; WIX -WL7447; TEN -OP359; GUD -M81

### Filters Cross Reference Chart

Part Number	Product Description	Potential OE Part Number	Potential Comp. Part Number
F026407006	Oil Filter Element	CHE-55594651, J93745801, 93185674, 55595651	MFR -ELH4368; SFM -S5064PE; BLP -ADG02147; CPF -FA5784ECO; GUD -M71; FLT -OE6486; CLF -ML4502; MHL -OX401D; FIM -FA5784ECO; TEN -OP301; CMI -EOF201; PRF -L387; WGA -WOE313; MN -HU6122X; AL -ALO81713; WIX -WL7422; ACD -55594651; PBR -AC8091; UFI -2506400; FRA -CH10246ECO; HEG -E611HD122, E611HD442
F026407269	Oil Filter Element	JAG-C2D3670	PRF -L987; BIL -ADJ132105; SFM -S5073PE; TEF -PEL725; TEN -OP1014; MHL -OX774D, OX774DECO; FRA -CH10992, CH10992ECO; CPF -FA6113ECO; ALC -MD739; UFI -2507302; HEG -E863HD360; AL -ALO8739; MN -HU8008Z; GUD -M138
F026407147	Oil Filter Element	HYU-263203C250, 263203C300, 263202A500, 263203C30A, 263303C300, 263102A610, 263203F100, 263102A510, 263203C700, 263202A501, 263102A520	AHK -10ECO076; LAT -I43; VAO -586579; FLT -OE6745; WIX -WL7477; MSF -L124; MN -HU7001X; MGA -FH1141; UFI -2515100; BLP -ADG02140; CMI -EOF251; HEG -E825HD265; CLF -ML4521; PRF -L409; JPP -FOECO076; MFR -ELH4398; EOR -1619270180; MHL -OX351D; MED -14118; CPF -FA5967ECO; SFM -S5151PE; AMK -HO602; FRA -CH10670ECO; GUD -M127; NIP -N1310508
F002H23432	Oil Filter Element	MRU-16510M86J00, 16500M86J20, 16510M86J20	
1457429619	Oil Filter Element	AUD-074115562	PBR -AC8002; MN -HU7261X, HU7262X; FLT -OE6401; HEG -E15326, E154HD48, D48E15326, E154H; LUB -LC124, P856; UFI -2501100; WIX -WL7008, 57210; MFI -MU1178, MO1178; GUD -M13; MPC -64804; FLG -LF16176; DEP -FX0114; ATU -P00009; PRF -L291; MHL -OX143DECO, OX143, OX143D; LAT -ELH4216; CPF -FA5412ECO; CHA -XE505; CLF -ML030; THO -5505; FIM -FA5412, FA5412ECO; ALC -MD355; ACD -AC6212E; SFM -S5011PE; KNE -OX143DOEKO, OX143D; COO -G1399; TEN -OP204; FRA -CH8530ECO, CH8530; CRO -1047; WGA -WOE610; MFR -ELH4216; PUR -L45308, L37735; CMI -EOF044

### Filters Cross Reference Chart

Part Number	Product Description	Potential OE Part Number	Potential Comp. Part Number
F026407278	Oil Filter Element	SKO-06L115466, 06L115562B, 06L115562, 06K115562, 06K115466, 06L115466C	KSS -4598OX; CPF -FA6107ECO; MQP -LVFL792; GUD -M143; MN -HU6013Z; TEF -PEL680; HEG -E358H, E358HD246; MPC -61206; FLT -OE6882; MFR -ELH4439; SFM -S5176PE1, S5153PE; MHL -OX1217D, OX835DECO, OX1107D, OX835D, OX1107DECO; UFI -2515300; KNE -OX1217D, OX835DECO, OX1107D, OX835D, OX1107DECO; BBF -P40010; FRA -CH11498ECO; WIX -WL7507; ALC -MD745; PRF -L980; TEN -OP1011; AHK -10ECO124; JPP -FOECO124; BLP -ADV182119; MYL -1003220022; MSF -L128; CLF -ML4536; MED -14164
0986452044	Oil Filter Element	TOY-1560016010, 0012000014, 90915YZZD4, 1560001020, 909153002, 90915YZZD2, 9091520004, 1560176009, 0415203002, 0892202002, 9091520003, 90915YZZJ3, 0892202010, 90915Y22D2, 0892202011, 0012000015, 9091520001, 1150101301, 9091503005, 90915TB001, 9008091210, 0892202004, 0892202001, 0909153002, 0415264010, 156017600971, 9091533021, 90915YZZJ4, 9091520002, 90915YZZB3, 9091503002, 0012000009, 90915YZZD1	UNO -C171; KSS -5100S; FLG -LF764; DON -P550335, LFP550335, P779197; COO -Z850, Z1015; MFR -ELH4241; CLF -DO339, DO911, DO910; SKR -C3001; AMK -TO131, TO138, TO133; RYC -Z700, Z334, Z87A, Z131A, Z418; FIM -FT4809, FT5274; PRF -LS359, LS161, LS164; KNE -AW1, OC478; UFI -2325300; GUD -Z118, Z117, Z217, Z217A; VIC -C111; FRA -PH4985, PH3614; CRO -2110, 591, 439, 531; CMI -CTY11111, CTY11171, EOF233; THO -4075; MN -W71180, W71283, W7171; AC -PF19, SF, SR, PF13, X19; PUR -PER17, MF45800A, L14477, L10241; MOT -MFL204, EFL344; CPF -FT4960; WIX -51348; PBR -BC1158; BLP -ADT32114; FLT -OP618; UNP -GFE114; HEG -H14W32; MHL -OC988, OC478
F026407320	Oil Filter Element	SKO-03H115562	MHL -OX983D; SOG -L1071; SFM -S5089PE; FRA -CH11242ECO; MQP -LVFL831; KNE -OX983D; HEG -E136HD428; BLP -ADV182123; MFR -ELH4501; ALC -MD713; MN -HU8009Z; AL -ALO8714; CMI -EOF281; PRF -L1071; UFI -2508900

### Filters Cross Reference Chart

Part Number	Product Description	Potential OE Part Number	Potential Comp. Part Number
1457429192	Oil Filter Element	AUD-071115466, 045115466C, 045115389J, 045115389C	CHA -XE525; SOP -OX188D; ACD -AC6206E; MN -HU7197X; FIM -FA5618ECO, FA5620ECO; MHL -OX188D, OX188DECO; TEF -PEL111; ALC -MD437; WGA -WOE630; HEB -J1315024; SFM -S5023PE; PUR -L38113; CMI -EOF087; CPF -FA5618AECO; CRO -2232, 2233; AMK -MO438; MFR -ELH4307; LAT -ELH4307; MPC -64806; BLP -ADA102101; MNC -HU7197X; FLT -OE6501; NIP -J1315028; HEG -E19HD83; FRA -CH9461, CH9461ECO, CH9463ECO, CH9463AECO; PBR -AC8043, AC8041; DEP -FX20036; UFI -2502300; PRF -L267D, L267A, L267, L263A; KSS -505OX; KNE -OX188DOEKO, OX188D; AL -ALO8119; COO -G1471, G1473; TEN -OP222, OP269, OP224, OP259; GUD -M29; WIX -WL7296; CLF -ML1705, ML1704
F002H23551	Oil Filter Element	MHI-8200867976, 7700274177, 8671002274, 8200768927, 8200768913	
1457429262	Oil Filter Element	BMW-11427508969, 11427619319, 11427501676, 11427619232, 11427530668	CHA -XE544606, COF100544E, XE544; VAO -586551; FIM -FA5641ECO; MN -HU8152X; TEF -PEL211; FBI -26705; ALC -MD455; KNE -OX1661DOEKO; GUD -M47; MAR -71760699; TEN -OP258; FIP -MLE1533; WIX -WL7403; PBR -AC8049; KSS -50013661, 661OX; MPC -64603; MFR -ELH4344; AHK -10ECO079; MCA -OF018; MFI -MU1210; CLF -ML1729; COO -G1549; MHL -OX1661D, OX166DECO, OX1661DECO, OX166D; LAT -ELH4344; PUR -L19102; AL -ALO8156; SKR -EO3005; CMI -EOF169; MQP -VFL512; MED -14086; FLT -OE6496; JPP -FOECO079; PRF -L367; MYL -3141140005; HEG -E29HD89; UFI -2502800; ACD -AC6280E; RYC -R2635P; CRO -2290; FRA -CH9547, CH9547ECO; SFM -S5028PE; BLP -ADB112106; TNO -OL09547E; MSF -L028; CPF -FA5641ECO
F002H23439	Oil Filter Element	MHI-9420000074, 9420000073, 0303BAM00350N, 0303BC0071N, 0303BC0010N, 0024772	
F026407175	Oil Filter Element	BMW-11427640862, 11427953125, 11428683204	KNE -OX387D1; GUD -M136; HEG -E61HD258; MN -HU816ZKIT; FLT -OE64910; PRF -L1141; MHL -OX387D1; WIX -WL7509
F026407275	Oil Filter Element		MHL -OX1138D; PRF -L994; FLT -OE6675; SOG -L994; TEF -PEL698; MN -HU6024Z; HEG -E867HD370

### Filters Cross Reference Chart

Part Number	Product Description	Potential OE Part Number	Potential Comp. Part Number
F026407123	Oil Filter Element	MBM-11428507683	CPF -FA6006ECO; GUD -M126; FRA -CH11217ECO; CMI -EOF242; HEG -E204HD218; MHL -OX404D, OX404DECO; WIX -WL7487A; FLT -OE6724; TEF -PEL729; PRF -L471; MN -HU6004X; BLP -ADB112107; MFR -ELH4436; UFI -2514200; SFM -S5142PE; TEN -OP423
F026407144	Oil Filter Element	VWW-03P115562	WIX -WL7489; GUD -M141; MFR -ELH4410; MN -HU7017Z; PRF -L508; CMI -EOF258, EOF240; BLP -ADV182114; FLT -OE6881; UFI -2511500; FRA -CH11266ECO; MHL -OX422D; HEG -E211H01D208
1457429152	Oil Filter Element	SKO-059115562	HEG -D44E350H, E350H, E350HD44; FIA -FA5558ECO; GUD -M33; SFM -S5019PE; MN -HU842X; MFI -MU1192, MO1192; CRO -1055, 1155; MHL -OX164D, OX164DECO; PRF -L317; CHA -XE542, XE513; FLT -OE650; TEN -OP223; FIM -FA5558ECO, FA5558; AL -ALO8142; THO -5513; LAT -ELH4283; LUB -LC133; DEP -FX0193; PBR -AC8021; WIX -WL7226; FRA -CA8980, CH8980ECO, CH8980; UFI -2501900; ACD -AC6218E; CMI -EOF068; COO -G1412; PUR -L47905; ALC -MD391; CLF -ML1701; MFR -ELH4283; KNE -OX164D
F026407122	Oil Filter Element	VWW-059115561D, 059198405	MFR -ELH4446; MHL -OX420D; PRF -L988; HEG -E816HD236; UFI -2514100; FRA -CH11490ECO; MN -HU8005Z; GUD -M133; WIX -WL7501; CMI -EOF263; FLT -OE6507
F002H23432	Oil Filter Element	TAE-59063972	
F026407023	Oil Filter Element	AUD-03L115562	TEF -PEL677; CMI -EOF236; MFR -ELH4407; SFM -S5106PE; FIM -FA5974ECO; MN -HU7008Z; UFI -2510600; JPP -FOECO098; ALC -MD679; GUD -M118; CLF -ML4509; MHL -OX388D; WIX -WL7476; SCT -SH4049P; FRA -CH10759ECO; PRF -L418; FLT -OE688; CPF -FA5974ECO; HEG -E115HD208, E115H01D208; BLP -ADV182110; ACD -AC6309E
F026407066	Oil Filter Element	AUD-057115561M	MHL -OX1963D; MFR -ELH4389; HEG -E73HD207; UFI -2510500; FLT -OE6506; FRA -CH10636ECO; GUD -M122; FIM -FA5960ECO; CMI -EOF244; PRF -L403; MN -HU8001X
F026407156	Oil Filter Element	HYU-263202F100, 263202F010, 263202F000	GUD -M130; MHL -OX377D; KNE -OX377D; HEG -E822HD255, E822HD315; WIX -WL7478; UFI -2516600; BLP -ADG02141; MFR -ELH4433; MN -HU7027Z; FLT -OE6746; AL -ALO8197; FRA -CH11276ECO; PRF -L473

### Filters Cross Reference Chart

Part Number	Product Description	Potential OE Part Number	Potential Comp. Part Number
F026407158	Oil Filter Element	BMW-11427580676, 7615380, 11427583220, 7610025, 11427600089, 11427848321	HEG -E359HD306; GUD -M139; AL -ALO8733; UFI -2520100; MHL -OX3537D, OX3537DECO; MN -HU8007Z; TEF -PEL216; PRF -L1069; KNE -OX3537D, OX3537DECO
9951030134	Oil Filter Element	TAE-254718130117	
1457429192	Oil Filter Element	VWW-045118466, 071115466, 045115466C, 071115562A, 071115562, 071115562B, 045115389J, 045115466B, 071115562C, 045115466, 045118389C, 045115466A, 070115562	CHA -XE525; SOP -OX188D; ACD -AC6206E; MN -HU7197X; FIM -FA5618ECO, FA5620ECO; MHL -OX188D, OX188DECO; TEF -PEL111; ALC -MD437; WGA -W0E630; HEB -J1315024; SFM -S5023PE; PUR -L38113; CMI -EOF087; CPF -FA5618AECO; CRO -2232, 2233; AMK -MO438; MFR -ELH4307; LAT -ELH4307; MPC -64806; BLP -ADA102101; MNC -HU7197X; FLT -OE6501; NIP -J1315028; HEG -E19HD83; FRA -CH9461, CH9461ECO, CH9463ECO, CH9463AECO; PBR -AC8043, AC8041; DEP -FX20036; UFI -2502300; PRF -L267D, L267A, L267, L263A; KSS -505OX; KNE -OX188DOEKO, OX188D; AL -ALO8119; COO -G1471, G1473; TEN -OP222, OP269, OP224, OP259; GUD -M29; WIX -WL7296; CLF -ML1705, ML1704
1457429144	Oil Filter Element	POR-99610722560, 99610722552, 99610722553	FRA -CH8278, CH10512, CH10512ECO; UFI -2516500; LUB -LC168, P838; MN -HU7195X, W7195X; CMI -EOF127; MHL -OX128, OX1281D, OX1281, OX128DECO, OX128D; PRF -L448; FLT -OE664; COO -G1797; ALC -MD475; LAT -ELH4319; HEG -E14HD77; PUR -L25316; KNE -OX1281D, OX128DOEKO; GUD -M20; ACD -AC6204E; MFR -ELH4319; WIX -57211, WL7297
F026407144	Oil Filter Element	SKO-03P115562	WIX -WL7489; GUD -M141; MFR -ELH4410; MN -HU7017Z; PRF -L508; CMI -EOF258, EOF240; BLP -ADV182114; FLT -OE6881; UFI -2511500; FRA -CH11266ECO; MHL -OX422D; HEG -E211H01D208
1457429119	Oil Filter Element	LRG-LRF100150L	FRA -CH9011, CH9011ECO; CRO -1053; CMI -EOF092; GUD -M9; ALC -MD337B; UFI -2500100; UNP -GFE391; CHA -XE518; PBR -AC8019; CLF -ML496, ML496A; FIM -FA5572ECO, ANF1276, FA5572; MN -HU7181Z; WIX -WL7236; MHL -OX153D2, OX153D2ECO; LAT -ELH4235; MFR -ELH4235; DEP -FX0190, FX190; PRF -L307; PUR -L28919; COO -G1413; ACD -AC6201E; SFM -S5001PE; WGA -W0E3003; TEN -OP217; SOP -OX153D2; MFI -MU1199, MO1199; HEG -E11HD26; FLT -OE6492; KNE -OX153D2; MPC -64863; LUB -LC136

### Filters Cross Reference Chart

Part Number	Product Description	Potential OE Part Number	Potential Comp. Part Number
F026407014	Oil Filter Element	REN-8200362442	FIM -FA5773ECO; FLT -OE6662; NIP -N1311037; BLP -ADN12127; UFI -2509400; WIX -WL7424; MHL -OX441DECO, OX441D, OX441; COO -G1669; HEG -E112HD180; CMI -EOF202; PBR -AC8086; FRA -CH11208ECO, CH10076ECO; ALC -MD631; TEN -OP281, TENOP281; HEB -J1311031; GUD -M107; KNE -OX441D; MN -HU618X; MFR -ELH4358; PRF -PRFFA5773ECO, L360, L470
F026407158	Oil Filter Element	ROL-11427583220	HEG -E359HD306; GUD -M139; AL -ALO8733; UFI -2520100; MHL -OX3537D, OX3537DECO; MN -HU8007Z; TEF -PEL216; PRF -L1069; KNE -OX3537D, OX3537DECO
F002H24987	Oil Filter Element	HON-15400RZOG01, 154005Z8E01	
F026407258	Oil Filter Element	JEE-68229402AA, K68229402AA, 68109834AA	FLT -OE6892; HEG -E216H01D301; MHL -OX1145DECO, OX1145D; SOG -L974; KNE -OX1145DECO, OX1145D; UFI -2511200; PRF -L974; MN -HU7018Z
1457437001	Oil Filter Element	MB-6111800009, 1121840025, A1121840025, A6111800009	DON -P550564; MHL -OX153D3ECO, OX153D3; UFI -2501300; ATU -P00342; FIM -FA5587ECO, FA5587, FA5420; BAC -P1443, P7198; SFM -S5013PE; PUR -L25536, L25276; DEP -FX20028; LAT -ELH4285; WGA -W0E3001; ALC -MD337D; LUB -P8153, LP4854; WIX -WL7240, 57038; GUD -M1; CRO -1051; TEN -OP212; MFR -ELH4285; FLT -OE6405; FRA -CH9301ECO, CH5993, CH9301; HEG -E11HD57; CHA -XE538, XE508; PBR -AC8072; COO -G1444, G1476, AG153; CMI -EOF073; ACD -AC6199E; PRF -L311; KNE -OX153D3, OX153D3OEKO; THO -5503; FLG -LF3997; MN -HU7181K; CLF -ML479, ML487, ML479A; MFI -MO1180, MU1180; TEF -PEL311
F026407023	Oil Filter Element	SKO-03L115562	TEF -PEL677; CMI -EOF236; MFR -ELH4407; SFM -S5106PE; FIM -FA5974ECO; MN -HU7008Z; UFI -2510600; JPP -FOECO098; ALC -MD679; GUD -M118; CLF -ML4509; MHL -OX388D; WIX -WL7476; SCT -SH4049P; FRA -CH10759ECO; PRF -L418; FLT -OE688; CPF -FA5974ECO; HEG -E115HD208, E115H01D208; BLP -ADV182110; ACD -AC6309E
F026407344	Oil Filter Element	BEY-07C115562E	MHL -OX557D; PRF -L1110; KNE -OX557D; WIX -57562; MSF -L239; MN -HU8010Z; HEG -E314H01D58



**Filters Cross Reference Chart**

Part Number	Product Description	Potential OE Part Number	Potential Comp. Part Number
1457429274	Oil Filter Element	MB-A6011800210, 6011800009, 6011800210, 6011840025, 6011840125, 6011800109, A6011840025, A6011800109, A6011800009, A6011840125	MOK -30784274; PUR -PL39D, L40039; MHL -OX38D; LAT -ELH4151; FIM -FB1526; CLF -ML082, ML82; TEN -O157; FLG -LF3585, LF3584; BOU -72162; ACD -AC202, AC6242E; SFM -S75100; FRA -C4, CH4536; MN -PF10501N, PF10501X; UNP -GFE288; NIP -J1310401; MNC -PF10501X; THO -D188, 5188; KSS -136OC; HEG -D16E170HN, E170HN, E170HND16, D15E170HN; PM -801837; AMK -SO802; ALC -MD249; COO -AZL025, G816; DON -P550361; SVA -SO941; MOT -EFL322; CHA -X103; WGA -JFO0997; LUB -P829, LC100; MFR -LI314, ELH4151; GUD -G1061; WIX -WL7004; HAF -HOF268; DEP -FX0104; BAC -P7615; PRF -L566; MFI -MO60, MO1160; HEB -J1310401; KNE -K013D, OX38D; WYT -WO7010; QHZ -QOF9616; CMI -EOF011; FLT -OC602; SOP -CA539; MPC -61157; CRO -1013; UFI -2552800; PBR -AC3277
F026407274	Oil Filter Element	POR-9A719840500	KNE -OX1184D; PRF -L1048; FLT -OE6884; HEG -E914HD398; MN -HU7049Z; WIX -WL7578; MHL -OX1184D; SOG -L1048
F026407112	Oil Filter Element	MB-6511800009, A6511800109, A6511800309, A1121840425, A6511840025, 1121840425, A6511800009, 6511800109, 6511840025, 6511800309	TEF -PEL676; HEG -E11HD204; CPF -FA6080ECO; UFI -2515900; MHL -OX15312D, OX1537D2, OX1537D2ECO, OX1537, OX15312DECO, OX15312; MN -HU7010Z; FRA -CH11277ECO; FLT -OE6774; GUD -M124; CMI -EOF253; PRF -L509; BIL -ADU172101; WIX -WL7470; ALC -MD683
1457429308	Oil Filter Element	HYU-2632027110, 2632027100	UFI -2507100; CMI -CHY11005; FIM -FA5727ECO; HEB -J1310501; FRA -CH9919ECO; NIP -J1310501; MHL -OX369D; MFR -ELH4380; AMK -HO604; FLT -OE6741; COO -G1642; TEN -OP255; WIX -WL7419; HEG -E839HD330; ALC -MD565; MN -HU714X; SFM -S5071PE; PRF -L365
1457429194	Oil Filter Element	VWW-03D198819, 03D115466B, 03D198819C, 03D115466A, 03D198819A	MHL -OX360DECO, OX360D; CPF -FA5640ECO; MFI -MU1215; MPC -64803; PRF -L339; FRA -CH9530ECO; ATU -P00140; PBR -AC8047; TEN -OP233; WIX -WL7318; PUR -L18340; KNE -OX360D; THO -5536; CHA -XE527; ACD -AC6191E; COO -G1538, AG1538; LAT -ELH4322; CMI -EOF143; ALC -MD427; HEG -E37HD84; FIM -FA5640ECO; DEP -FX20037; SFM -S5029PE; CLF -ML060; UFI -2502900; FLT -OE671; MN -HU710X; KSS -364OX; MFR -ELH4322

**Filters Cross Reference Chart**

Part Number	Product Description	Potential OE Part Number	Potential Comp. Part Number
F026407173	Oil Filter Element	BMW-11427611969, 11427605342, 11427635557	HEG -E820HD245; FLT -OE6725; WIX -WL7502; TEN -OP1004; UFI -2516400; CMI -EOF257; TEF -PEL220; MN -HU7003X; MHL -OX825, OX825DECO, OX825D; FRA -CH11461ECO; PRF -L972; GUD -M144
F026407102	Oil Filter Element	POR-94810722200, 94810702200, OPB115466	UFI -2521000; PRF -L1038; GUD -M140; MHL -OX254D4; HEG -E113HD235; MN -HU9001X; CMI -EOF275
F026407269	Oil Filter Element	LRG-LR011279	PRF -L987; BIL -ADJ132105; SFM -S5073PE; TEF -PEL725; TEN -OP1014; MHL -OX774D, OX774DECO; FRA -CH10992, CH10992ECO; CPF -FA6113ECO; ALC -MD739; UFI -2507302; HEG -E863HD360; AL -ALO8739; MN -HU8008Z; GUD -M138
F026407255	Oil Filter Element	BMW-11427837997	KNE -OX254D3; PRF -L1106; MHL -OX254D3; MN -HU9265Z, HU9265X
1457429256	Oil Filter Element	FIA-55245952, K6001073250, K68102241AA, 2504300, 6000626333, 68102241AA, 6001073250, 71773176, 73500049, K6000626333, 71765460	NIP -J1318013; CMI -EOF174; FRA -CH9713, CH12038ECO, CH9713ECO; HEG -E60HD110; EOR -E149038; UFI -2504300; TEN -OP246; JPP -FOECO044, JFOECO044; MFR -ELH4339; MN -HU7041Z, HU7131X; WIX -WL7408; FLT -OE670; BLP -ADK82104; AMK -SO918; MSF -L112; CLF -ML1708; FBI -26366; PBR -AC8053; LUC -LFOE216; VAO -586516; PRF -L330, L466, FA5677ECO; LAT -I16; MHL -OX371D; MQP -VFL518; SFM -S5043PE; FIM -FA5677ECO, FA5677, FA6780ECO; CPF -FA5677ECO, FA6780ECO; KNE -OX371D; COO -G1590; CRO -2272; WGA -WOE909; AHK -10ECO044; GUD -M68
9451037456	Oil Filter Element	TAE-253418130129, 252718130105	FLG -LF16059
F026407002	Oil Filter Element	VWW-057115561L, 057002561L, 057115561K, 57115561K, 57115561L	TEN -OP285; MN -HU831X; MHL -OX1961D; FRA -CH10197ECO, CH10197; MFR -ELH4383; HEG -E73HD134; WIX -WL7486A, WL7439, WL7439A; PRF -L382; CMI -EOF182; KNE -OX1961D, OX1961DECO; UFI -2506800; WGA -WOE611; GUD -M72; FLT -OE6503
1457429261	Oil Filter Element	MB-A2711800109, 2711800109, A2711840225, 2711800009, A2711840125, 2711840225, 2711840125, A2711800009	KNE -OX1831DOEKO, OX1835D1; MN -HU514X; FIM -FA5728ECO; HEG -E38HD106; CLF -ML1731; THO -5542; PRF -L366; CHA -XE550; MFR -ELH4346; KSS -659OX; WIX -WL7322; GUD -M66; FLT -OE6408; CMI -EOF168; COO -G1649; TEN -OP256; LUB -P963; ALC -MD543; MFI -MU1226; LAT -ELH4346; UFI -2505000; PBR -AC8057, AC8078; CPF -FA5728ECO; MHL -OX1835D1, OX1831D, OX1831DECO; AL -ALO8152; SFM -S5050PE; FRA -CH9918ECO; PUR -L45514; MNC -HU514X

**Filters Cross Reference Chart**

Part Number	Product Description	Potential OE Part Number	Potential Comp. Part Number
1457429263	Oil Filter Element	MB-1121800009, A1121800610, A6641800109, 1121840525, 1121800610, 1121840025, A0001803109, A1121840025, 1121800710, A1121840525, A1121800710, 1121800110, 1121840625, 6641800009, A0001802609, 0001802209, 0001802609, 0011849425, 0001803109, 000180260990, A1121800510, 1121840125, 1121840225, 0001802309, A000180260990, A1131800010, A1121840125, A1121840225, 1121840425, 6111800967, A6111800967, A1121800009, 6641800109, 1131800010, A1121840625, A1121840425, A0001802309, 1121800510, A1121800110, A0001802209, A6641800009, A0011849425	ATU -P00042; CLF -ML479, ML487, ML487A, ML479A; TEN -OP208; MPC -64880; SFM -S5002PE; ALC -MD337C; CPF -FA6792ECO, FA5441ECO; CHA -XE509, XE551, XE537; MNC -HU7185X; PUR -L27830, L25277, L25276; PBR -AC8017; HEG -E11H01, E11H02D155, E11HD155, E11H01D50, E11HD50; PRF -L305, L1072; BLP -ADA102102; FLT -OE683, OE6402; DEP -FX0181; KNE -OX3457D, OX345DOEKO; TEF -PEL718; UFI -2500200; WIX -WL7009; RYC -R2606P; WFF -WCO38; FRA -CH8902, CH8607, CH8902ECO; LUB -P8153; CRO -1044; CMI -EOF045; GUD -M6; DON -P550798; LAT -ELH4345, ELH4234; MHL -OX1537DECO, OX345, OX3457D, OX345DECO, OX1537, OX345D, OX1537D, OX153D; FIM -FA5441; MN -HU7185X; THO -5504; BAC -P1143; MFR -ELH4345, ELH4234
F026407231	Oil Filter Element	MB-A2811800010, A2811800210, 2001800009, 2811800010, A2001800009, 2811800210	CPF -FA6086ECO; NIP -N1311042; MSF -L145; HEG -E823HD263; MHL -OX968DECO, OX968D; PRF -L441; KNE -OX968DECO, OX968D; FRA -CH11442ECO; TEN -OP1003; GUD -M157; FLT -OE6663; MN -HU10002Z; MFR -ELH4443; WIX -WL7506; FIM -FA6086ECO; SFM -S5145PE; LUC -LFOE258; BLP -ADN12134; UFI -2514500
F026407270	Oil Filter Element	AUD-059198405B, 059115561G	MHL -OX1076D; HEG -E219HD330; TEF -PEL684; FLT -OE6508; MN -HU7012Z; WIX -WL7535; PRF -L1075; UFI -2518000
F026407341	Oil Filter Element	MB-0001803009, A1561840125, 1561840125, A0001803009	WIX -57010; MN -HU8012Z; MSF -L238; KNE -OX1161D; PRF -L1102; MHL -OX1161D; BLP -ADU172102; HEG -E149HD114

**Filters Cross Reference Chart**

Part Number	Product Description	Potential OE Part Number	Potential Comp. Part Number
1457429257	Oil Filter Element		FLT -OE665, OE6652; NIP -J1313025, J1313023; CHA -XE524; MOT -EFL404; COO -G1414; WFF -WCO56; FRA -CH8814, CH8814ECO, CH9382ECO; MHL -OX203DECO, OX203D; UFI -2505600; HEG -E20HD79; PBR -AC8038; ALC -MD431; MFI -MU1211; MPC -64600; TEF -PEL106; TEN -OP234; KNE -OX203D, OX203DOEKO; QHZ -WL7292; CRO -2252; LAT -ELH4320; ACD -AC6192E; GUD -M49; MFR -ELH4320, ELH4352; VIC -O406; WGA -WOE120; AMK -MO533; SFM -S5056PE; THO -5535; PRF -L340; WIX -WL7292; CLF -ML1703; FIM -FA5593ECO; PUR -L18367, L15505; DEP -FX20032; MN -HU7112X, HU711X; CMI -EOF084; RYC -R2604P; KSS -866OX
F026407345	Oil Filter Element	MB-A1771803300, 1761800800, 1771803300, A1761800800, 1331840025, A1331840025	FBI -172948; HEG -E155H01D122; MSF -L212; BLP -ADBP210065; MFR -ELH4514; MN -HU60081Z; MHL -OX1236D; KNE -OX1236D
F026407123	Oil Filter Element	BMW-11428507683	CPF -FA6006ECO; GUD -M126; FRA -CH11217ECO; CMI -EOF242; HEG -E204HD218; MHL -OX404D, OX404DECO; WIX -WL7487A; FLT -OE6724; TEF -PEL729; PRF -L471; MN -HU6004X; BLP -ADB112107; MFR -ELH4436; UFI -2514200; SFM -S5142PE; TEN -OP423
1457429252	Oil Filter Element	BMW-11427788460, 11428513377, 11427788454, 11428513378, 11427788461	CMI -EOF170; MN -HU7214X; PRF -L369; FLT -OE6498; RYC -R2636P; FRA -CH9994ECO; CHA -XE549; SFM -S5048PE; TEN -OP261; HEG -E28H01D26; LAT -ELH4359; AL -ALO8132; ALC -MD519; MFI -MU1227; MHL -OX1773, OX1773D, OX1773DECO; UFI -2504800; KNE -OX1773DOEKO; WIX -WL7406; WGA -WOE213; MFR -ELH4359; BLP -ADB112101; KSS -652OX; CPF -FA5752ECO
F026407126	Oil Filter Element	LRG-LR002338	UFI -2506800; FRA -CH11478ECO; GUD -M116; FLT -OE6506; MN -HU8003X; MHL -OX1961D1; PRF -L977; HEG -E838HD329
F026407096	Oil Filter Element	FIA-55206816, 55214974, 71751128, 71770689, 71777723, 55207208, 71751114, 71751127	WIX -WL7464; GUD -M117; FLT -OE6822; UFI -2506100; JPP -FOECO095; MFR -ELH4390; CLF -ML4500; FIM -FA5919ECO; PRF -L400; SFM -S5061PE; CPF -FA5919ECO; BLP -ADK82107; MHL -OX553D; HEG -E157HD227; MN -HU71211X; CMI -EOF221; FRA -CH10623ECO
F026407274	Oil Filter Element	AUD-06M115561E, 06M198405F, 06M115561H	KNE -OX1184D; PRF -L1048; FLT -OE6884; HEG -E914HD398; MN -HU7049Z; WIX -WL7578; MHL -OX1184D; SOG -L1048

### Filters Cross Reference Chart

Part Number	Product Description	Potential OE Part Number	Potential Comp. Part Number
F026407312	Oil Filter Element	POR-9A110722400, OPB115466A, 9A110702400, OPB115499A	KNE -OX366D; UFI -2519800; MHL -OX366D; HEG -E835HD325; FRA -CH11008ECO; COO -FA6112ECO; SFM -S5198PE; PRF -L986; BLP -ADV182148; MN -HU7026Z
F002H20377	Oil Filter Element	MRU-16510M82713, 16510M73080, 16510M82703, 16510M73010	
F026407277	Oil Filter Element	BMW-11428593186	MHL -OX1238D; PRF -L1133; KNE -OX1238D; MN -HU6012ZKIT; SFM -S5211PE; FLT -OE6729; UFI -2521100; HEG -E951HD497; TEF -PEL699
F026407066	Oil Filter Element	POR-95510722200	MHL -OX1963D; MFR -ELH4389; HEG -E73HD207; UFI -2510500; FLT -OE6506; FRA -CH10636ECO; GUD -M122; FIM -FA5960ECO; CMI -EOF244; PRF -L403; MN -HU8001X
F026407278	Oil Filter Element	POR-95811556200, 95811556201, 95811546600	KSS -4598OX; CPF -FA6107ECO; MQP -LVFL792; GUD -M143; MN -HU6013Z; TEF -PEL680; HEG -E358H, E358HD246; MPC -61206; FLT -OE6882; MFR -ELH4439; SFM -S5176PE1, S5153PE; MHL -OX1217D, OX835DECO, OX1107D, OX835D, OX1107DECO; UFI -2515300; KNE -OX1217D, OX835DECO, OX1107D, OX835D, OX1107DECO; BBF -P40010; FRA -CH11498ECO; WIX -WL7507; ALC -MD745; PRF -L980; TEN -OP1011; AHK -10ECO124; JPP -FOECO124; BLP -ADV182119; MYL -1003220022; MSF -L128; CLF -ML4536; MED -14164
F026407002	Oil Filter Element	AUD-057115561L	TEN -OP285; MN -HU831X; MHL -OX1961D; FRA -CH10197ECO, CH10197; MFR -ELH4383; HEG -E73HD134; WIX -WL7486A, WL7439, WL7439A; PRF -L382; CMI -EOF182; KNE -OX1961D, OX1961DECO; UFI -2506800; WGA -WOE611; GUD -M72; FLT -OE6503
F026407314	Oil Filter Element	POR-9A210722500, OPC115466	SFM -S5149PE; KNE -OX1218D; MHL -OX1218D; HEG -E911HD455; UFI -2514900; MN -HU7051Z; PRF -L1084
F026407011	Oil Filter Element	AUD-079198405E, 079198405B	WIX -WL7468; CMI -EOF209; GUD -M103; FLT -OE6505; KNE -OX350DECO, OX350D; MHL -OX3504D, OX350DECO, OX350D; FRA -CH11079ECO; UFI -2514300; MN -HU7005X, HU7188X; MFR -ELH4384; HEG -E813HD188, E813H01D188; PRF -L456
F026407313	Oil Filter Element		PRF -L1070; MN -HU7024Z; KNE -OX1123D; AL -ALO8758; SFM -S5090PE; MHL -OX1123D; ALC -MD841; BLP -ADV182115; MQP -LVFL814; HEG -E861HD413; UFI -2509000; FRA -CH11791ECO

### Filters Cross Reference Chart

Part Number	Product Description	Potential OE Part Number	Potential Comp. Part Number
F00E369874	Oil Filter Element Eco	MB-1121840525, A1121840225, A0001803109, 6111800967, A6111800967, A1121840525, A1121840625, 1121840625, A0001802609, 0001802209, A0001802309, 0001802609, 0011849425, 0001803109, A0001802209, 1121840225, 0001802309, A0011849425	FRA -CH8481; WIX -57078
0451103314	Oil Filter Spin-on	SKO-06A115561B, 06A115561, 06A115561E	THO -4073; HEG -H14W15, H14W27; SFM -S3436R, S3291R; KNE -OC240, OC264; MRO -8671000207; LAT -ELH4297; CLF -DO894, DO907; WFF -WZ553; GUD -Z362; WIX -WL7071; LUC -EDL973; TEN -R326, R640, R130; UFI -2329100, 2343600; MPC -61096; MHL -OC240, OC264, OC154; MFR -ELH4297; MN -W71930; RYC -Z553; DEL -FX130; DEP -FX0130; ALC -SP1137, SP978; UNP -GFE352; FRA -PH10298, PH5552; CMI -EOF036; PUR -L20252, L27017; CHA -C149, C183, LS300; SOP -OC240, OC264; CRO -2005; FIM -FT5259; MFI -MH3392; PRF -LS255, LS324; LUB -LS200, LS300; KSS -1610S, 5290S; PBR -BC1278; FLT -OP5261; HAF -HOF250; MNC -W71930; COO -Z1195, Z1758; SVA -SO592; TEF -PSL564
F026407022	Oil Filter Spin-on	DAC-8200867980, 8200768927	UFI -2348100; CMI -EOF216; TEN -R283; JPP -FO122S; MFR -ELH4392, ELH4333; SFM -S3820R; UNP -GFE584; WIX -WL7427; FIM -FT5901, FT5688; BLP -ADN12121; MHL -OC727, OC1290; FLT -OP6434; PRF -LS933, LS926; CPF -FT5901; FRA -PH9739; MN -W7069, W79; GUD -Z559; HEG -H221W; KNE -OC1290, OC471
F002H60001	Oil Filter Spin-on	TAE-279018130104, 279018130106, 279018130105	

**Filters Cross Reference Chart**

Part Number	Product Description	Potential OE Part Number	Potential Comp. Part Number
0451103314	Oil Filter Spin-on	VWW-06A115561A, 06A115561D, 078115561K, 037115561B, 1JM115561BZ, 06A115561B, 06A115561, 06A115561E, 035115561G, 034115561A	THO -4073; HEG -H14W15, H14W27; SFM -S3436R, S3291R; KNE -OC240, OC264; MRO -8671000207; LAT -ELH4297; CLF -DO894, DO907; WFF -WZ553; GUD -Z362; WIX -WL7071; LUC -EDL973; TEN -R326, R640, R130; UFI -2329100, 2343600; MPC -61096; MHL -OC240, OC264, OC154; MFR -ELH4297; MN -W71930; RYC -Z553; DEL -FX130; DEP -FX0130; ALC -SP1137, SP978; UNP -GFE352; FRA -PH10298, PH5552; CMI -EOF036; PUR -L20252, L27017; CHA -C149, C183, LS300; SOP -OC240, OC264; CRO -2005; FIM -FT5259; MFI -MH3392; PRF -LS255, LS324; LUB -LS200, LS300; KSS -161OS, 529OS; PBR -BC1278; FLT -OP5261; HAF -HOF250; MNC -W71930; COO -Z1195, Z1758; SVA -SO592; TEF -PSL564
0451103354	Oil Filter Spin-on	FIA-46468378, 46805832, 60814435, 46519728, 71736158, 46423474, 46402457, 7604770	WIX -WL7265, WL7083, WL7266; FRA -PM5754, PH9727, PH5139, PH5675; MFR -ELH4316; SFM -S6210R, S3252R, S8150R, S3530R, S6400R, S7250R, S7150R; CMI -EOF039, EOF194; CLF -DO917, DO1824, DO1815, DO870; ALC -SP1077, SP986; CHA -F112, F108, F106; PBR -BC1330, BC1242, BC1290; KNE -OC222, OC296, OC287, OC243; MHL -OC222, OC296, OC287, OC243; FIM -FT5681, FT5146, FT5310, FT5332; CRO -2157, 2195; HEG -H14W29, H14W24, H14W17; ACD -X4108E; SVA -92849817, SO608, SO498; UFI -2343400, 2325200, 2329500, 2321200, 2344900; GUD -Z528; PUR -L27728, L37541, L27729; PRF -LS346, LS297; LUB -LS136, LS162; TEN -R353, R126, R518, R46; LAT -ELH4316, ELH4227; COO -Z1202, Z1376; MN -W7144; FLT -OP5371, OP6202; THO -4300, OK300
F026407022	Oil Filter Spin-on	NIS-15208AW300, 1520800QAF, 1520800Q0D, 1520800Q0G	UFI -2348100; CMI -EOF216; TEN -R283; JPP -FO122S; MFR -ELH4392, ELH4333; SFM -S3820R; UNP -GFE584; WIX -WL7427; FIM -FT5901, FT5688; BLP -ADN12121; MHL -OC727, OC1290; FLT -OP6434; PRF -LS933, LS926; CPF -FT5901; FRA -PH9739; MN -W7069, W79; GUD -Z559; HEG -H221W; KNE -OC1290, OC471

**Filters Cross Reference Chart**

Part Number	Product Description	Potential OE Part Number	Potential Comp. Part Number
0451103313	Oil Filter Spin-on	AUD-078115561J	HEG -H24W04; LUB -LS210, PH2701; UFI -2346500, 2346540; COO -Z1417; ALC -SP979; CMI -EOF047; MFR -ELH4280; PUR -L30257, L25401; MPC -61200; CRO -2200; DEP -FX20017, FX20002, FX0131; WIX -WL7321, WL7072; WGA -WO344; MN -W93021, W93019; FRA -PH8994; LAT -ELH4280; FIM -FT5567, FT5363; ACD -FX20017, X4085E; SFM -S6620R; GUD -Z358; FLT -OP5265, OP5262; TEN -R266, R299; MHL -OC485, OC241, OC311; KNE -OC485, OC241, OC311; PRF -LS214, LS274, LS274A; KSS -350OS, 514OS; CLF -DO896
0451103079	Oil Filter Spin-on	OPE-93156954, VOF93, 93156300, 93156171, 90348728, 90144675, 650401, 650389, G93156245, 93156245, 650381	CLF -DO229; MN -W71275, W71222; FLT -OP570, OP570T; CPF -FT4970; APD -LK1013; PBR -BC1154; CMI -CDW11001, EOF002; UNP -GFE8057; FIM -FT4970, FT4970CS; PRF -LS206; MOZ -15; GUD -Z156; TEN -R317; UFI -2312902; MFR -ELH4120; RYC -Z154; ALC -SP935; MOT -AFL41, EFL257, MFL275; MHL -OC90, OC90OF; CHA -G102, F114; FRA -PH3387A, PH4722; SVA -SO432; ACD -X93; WFF -WZ154; HEG -H90W03; DON -P550047, LFP550047; CRO -2024; PUR -L17244, PER244, L10111; KNE -OC90, OC90OF; THO -4112; KSS -100OS; AC -X93; COO -Z520; WIX -WL7129, 51040; NIP -J1310900
F002H24987	Oil Filter Spin-on	HON-15400RZ0G01, 154005Z8E01	
F026407209	Oil Filter Spin-on	REN-8660005350, 152085758R, 7701068766, 1521021920, 152089F60A, 152009645R, 7701053054, 1520865F0A, 152088066R	CLF -DO853A, DO853; LUC -LFOS159; SFM -S3484R; LAT -H59; NIP -J1310500, J1311026, J1311022, J1311018; CPF -FT5368; VIC -C806, C224; FLT -OP595; MHL -OC1566, OC1052; UFI -2348400; MQP -VFL390; AHK -1001120, 1005593; GUD -Z653; MN -W671, W6025; KNM -RB197, RB222; AMK -NO2223, HO821; FRA -PH5594A, PH11275, PH4998, PH5594; FIM -FT5406, FT6081, FT5368; UNO -C218, C560; BLP -ADG02109, ADN12112; MSF -Z452; PUR -L18097; VAO -586022; TEF -PSL78; DEP -X597; KNE -OC1566, OC1052; WIX -WL7537, 51358; TEN -R205, R215, R438; PBR -BC1375; JPP -FO593S, JFO120S, FO120S, JFO197, FOH05S, JFO593S; PRF -LS301, LS965; SKR -C1855; HEG -H13W03, H313W, H97W06; FLG -LF3692; EOR -E149082; MFR -ELH4440, ELH4243



**Filters Cross Reference Chart**

Part Number	Product Description	Potential OE Part Number	Potential Comp. Part Number
F026407077	Oil Filter Spin-on	HON-15400PH1F02, 15400PR3004, 15400PLMA01, 15400MJ0003, 15400RAFT01, 15400RTA003, 15400PH305, 15400PC6004, 15400679003, 15400PK1003, 15400611003, 15400PT1K01, 15400PLC003, 15400PH1F01, 15400679004, 15400PR3014, 15400PH1003, 15400PLC004, 15400RBAF01, 15200PH1004, 15400PCX004, 15400PH9004, 15400PLMA02, 15400PR3003, 15400PH1F03, 15400679013, 04154PR3E00, 15400679023, 15400PR3305, 15400PH1014, 15400RTA004, 15220PH1014, 15400PMET01, 15400PC6003, 15400PH1004	HEB -J1314018; PUR -L14459; KNE -OC617; UFI -2324300; MN -W6106; BLP -ADM52107, ADH22114; HEG -H97W05; GUD -Z428, Z226, Z218; WIX -WL7134; PRF -LS350; FLT -OP575; MHL -OC617; MFR -ELH4405
F002H23434	Oil Filter Spin-on	TAE-279018130104, 279018130106, 279018130105, G279018130106	
F002H23432	Oil Filter Spin-on	MRU-16510M86J00, 16500M86J20, 16510M86J20	
F026407183	Oil Filter Spin-on	VWW-03C115561H, 03C115561D, 03C115561E	CMI -EOF250; FLT -OP6412; PRF -LS391, LS391A; HEG -H314W01; GUD -Z567; UFI -2357300; MHL -OC5933; CPF -FT6035, FT6035A; MN -W71294; FRA -PH10757A
F026407022	Oil Filter Spin-on	REN-8200274858, 8200867980, 8200768927	UFI -2348100; CMI -EOF216; TEN -R283; JPP -FO122S; MFR -ELH4392, ELH4333; SFM -S3820R; UNP -GFE584; WIX -WL7427; FIM -FT5901, FT5688; BLP -ADN12121; MHL -OC727, OC1290; FLT -OP6434; PRF -LS933, LS926; CPF -FT5901; FRA -PH9739; MN -W7069, W79; GUD -Z559; HEG -H221W; KNE -OC1290, OC471

**Filters Cross Reference Chart**

Part Number	Product Description	Potential OE Part Number	Potential Comp. Part Number
F026407080	Oil Filter Spin-on	AUD-06J115561B, 06J115403Q	TEF -PSL557; MHL -OC456; UFI -2349300; FLT -OP5267; CMI -EOF227; MN -W71945; GUD -Z552; WIX -WL7466; PRF -LS937; HEG -H14W30; MFR -ELH4428; WGA -WO592; KNE -OC456; FRA -PH10600
F026407078	Oil Filter Spin-on		FRA -PH10044, PH5556; COO -Z1207, Z1754; UNP -GFE676, GFE348; HEG -H90W22, H315W; MAR -71761637; TEN -R715, R530; SFM -S3413R, S8540R, S9431R; ACD -X4316E; VAO -586039; CRO -2331, 2278, 2152; UFI -2341300, 2326700; KSS -50013511, 5110S; MPC -61601; WIX -WL7187, WL7459; CLF -DO1841, DO942; MQP -VFL564; CMI -EOF023; FLT -OP629T, OP629, OP627, OP6291; THO -4352; PUR -L17201; MOT -EFL010, EFL10; JPP -JFO395S, FO395S, FO395, JFO395; MFR -ELH4370; PBR -BC1158, BC1363; MN -W71281, W7008; BLP -ADM52122; FIM -FT5914; PRF -LS934, LS277; GUD -Z435, Z551; SVA -SO614; HAF -HOF251; ALC -SP1073, SP1072; MED -152388; CPF -FT5914; HFR -76052388; MHL -OC1051, OC244
F002H23550	Oil Filter Spin-on	MRU-16510M68K10, 16510M68K00	
F002H23566	Oil Filter Spin-on	TAE-253418130169, 254718130117	FLG -LF16056
0451103316	Oil Filter Spin-on	HYU-2630035504, 2630035503, 2630035505	BAL -B227; FLT -OP536, OP617; AMK -IA372, MO429; UNO -C341, C331, C340; MFR -ELH4293, ELH4146, ELH4264, ELH4260; PUR -PL14459, L14459, L14622, L10193; UFI -2316500; LUB -LS116, LS185; MIR -T8307, T7316; BLP -ADC42112; NIP -J1315002, J1317003, J1315010; CRO -672, 2162, 2145, 2128; SVA -SO222, SO229; FRA -PH2871A, PH3950, PH6811, PH4870; PRF -LS489A, LS465; GUD -Z91D, Z243, Z91B, Z91C; MN -W71218, W81180; VIC -C307; CMI -CMB11341, CIZ11020; DEL -FX166, FX175, FX51, FX141; FLG -LF3403, LF3649, LF3462, LF3591; CHA -F123, F119, F110, F113; WFF -WZ79, WZ142A; COO -Z819, Z91; MOT -MFL263, MFL248, EFL130, AFL79A; HEG -H13W01; KNE -OC205, AW207, OC230; MHL -OC205, OC500, OC1673; CLF -DO883; DON -P502009, P550162, LFP550162; SOP -OC230; CPF -FT5447; WIX -51334, WL7171; UNP -GFE228, GFE324; RYC -Z79A, Z142A, Z193, Z426

**Filters Cross Reference Chart**

Part Number	Product Description	Potential OE Part Number	Potential Comp. Part Number
F026407209	Oil Filter Spin-on	HYU-2630002751, 2630002500, 2630002750, S2630003001, 2630003000, 2630003001, S2630002750, 2630002502, S2630002500, 2630002501, 2630002752	CLF -DO853A, DO853; LUC -LFOS159; SFM -S3484R; LAT -H59; NIP -J1310500, J1311026, J1311022, J1311018; CPF -FT5368; VIC -C806, C224; FLT -OP595; MHL -OC1566, OC1052; UFI -2348400; MQP -VFL390; AHK -1001120, 1005593; GUD -Z653; MN -W671, W6025; KNM -RB197, RB222; AMK -NO2223, HO821; FRA -PH5594A, PH11275, PH4998, PH5594; FIM -FT5406, FT6081, FT5368; UNO -C218, C560; BLP -ADG02109, ADN12112; MSF -Z452; PUR -L18097; VAO -586022; TEF -PSL78; DEP -X597; KNE -OC1566, OC1052; WIX -WL7537, 51358; TEN -R205, R215, R438; PBR -BC1375; JPP -FO593S, JFO120S, FO120S, JFO197, FOH05S, JFO593S; PRF -LS301, LS965; SKR -C1855; HEG -H13W03, H313W, H97W06; FLG -LF3692; EOR -E149082; MFR -ELH4440, ELH4243
F002H60003	Oil Filter Spin-on	TAE-253418130129	
F002H24311	Oil Filter Spin-on	MRU-16510M82713, 16510M73080, 16510M73013, 16510M82703, 16510M73010	
F026407304	Oil Filter Spin-on	ISU-8973587200, 8971679720, ZA8971679720	MHL -OC584; FRA -PH11138; COO -Z1552; BLP -ADZ92122; FLG -LF16267; NIP -J1319018; RYC -Z600; GUD -Z538; AMK -IO3337; MQP -LVFL837; VIC -C524; KNE -OC584; HEB -J1319018; MN -W8018; ASF -SP795; ALC -SP1061; DON -P506008; SKR -C1527, C15271
F002H20264	Oil Filter Spin-on	TAE-279018130101, 279018130102, G279018130103	FLG -LF16080
F002H24521	Oil Filter Spin-on	CHE-J25181616, J96980028	
F026407203	Oil Filter Spin-on	LRG-LR025306, LR096524	PRF -LS357; HEG -H90W27, H319W; UFI -2363200; MFR -ELH4369; FLT -OP5322; WIX -WL7510; MOT -EFL910, EFL907, FL910S; GUF -GFO157; GUD -Z586; FRA -PH9566, PH9460; MGA -FH1129; MHL -OC466, OC1063; TEF -PSL164; KNE -OC466, OC1063; CHA -C182; MN -W7015
0451103300	Oil Filter Spin-on	FIA-9558048380, 71753742, 60655594, 46805832, 60612882, 46423474, 60621830, 60657858, 46468378, 7715489, 71736159, 60810852, K9558048380, 606218900, 60621890, 46808398	UFI -2341500; CHA -F133; THO -4344; KNE -OC272; FLT -OP5371, OP5451; FIM -FT5333, FT5332; GUD -Z423; KSS -5450S; FRA -PH5752; CMI -EOF039; PRF -LS296; HEG -H90W15; MFR -ELH4330, ELH4257; MN -HU7182X, W71216; WIX -WL7083; CRO -2194

**Filters Cross Reference Chart**

Part Number	Product Description	Potential OE Part Number	Potential Comp. Part Number
0986452044	Oil Filter Spin-on	TOY-1560016010, 0012000014, 90915YZZD4, 1560001020, 909153002, 90915YZZD2, 9091520004, 1560176009, 0415203002, 0892202002, 9091520003, 90915YZZJ3, 0892202010, 90915Y22D2, 0892202011, 0012000015, 9091520001, 1150101301, 9091503005, 90915TB001, 9008091210, 0892202004, 0892202001, 0909153002, 0415264010, 156017600971, 9091533021, 90915YZZJ4, 9091520002, 90915YZZB3, 9091503002, 0012000009, 90915YZZD1	UNO -C171; KSS -5100S; FLG -LF764; DON -P550335, LFP550335, P779197; COO -Z850, Z1015; MFR -ELH4241; CLF -DO339, DO911, DO910; SKR -C3001; AMK -TO131, TO138, TO133; RYC -Z700, Z334, Z87A, Z131A, Z418; FIM -FT4809, FT5274; PRF -LS359, LS161, LS164; KNE -AW1, OC478; UFI -2325300; GUD -Z118, Z117, Z217, Z217A; VIC -C111; FRA -PH4985, PH3614; CRO -2110, 591, 439, 531; CMI -CTY11111, CTY11171, EOF233; THO -4075; MN -W71180, W71283, W7171; AC -PF19, SF, SR, PF13, X19; PUR -PER17, MF45800A, L14477, L10241; MOT -MFL204, EFL344; CPF -FT4960; WIX -51348; PBR -BC1158; BLP -ADT32114; FLT -OP618; UNP -GFE114; HEG -H14W32; MHL -OC988, OC478
F026407176	Oil Filter Spin-on	DAC-152085488R, 152089599R	MSF -Z642; PRF -LS946; MHL -OC978; CPF -FT6088; TEN -R998; WIX -WL7513; GUD -Z614; CLF -DO5515; HEG -H14W42; UFI -2362800; FLT -OP6435; FRA -PH11440; CMI -EOF285; MN -W7032; MQP -LVFL803; BLP -ADN12133
0451103314	Oil Filter Spin-on	AUD-06A115561D, 06A115561B, 06A115561E, 035115561G	THO -4073; HEG -H14W15, H14W27; SFM -S3436R, S3291R; KNE -OC240, OC264; MRO -8671000207; LAT -ELH4297; CLF -DO894, DO907; WFF -WZ553; GUD -Z362; WIX -WL7071; LUC -EDL973; TEN -R326, R640, R130; UFI -2329100, 2343600; MPC -61096; MHL -OC240, OC264, OC154; MFR -ELH4297; MN -W71930; RYC -Z553; DEL -FX130; DEP -FX0130; ALC -SP1137, SP978; UNP -GFE352; FRA -PH10298, PH5552; CMI -EOF036; PUR -L20252, L27017; CHA -C149, C183, LS300; SOP -OC240, OC264; CRO -2005; FIM -FT5259; MFI -MH3392; PRF -LS255, LS324; LUB -LS200, LS300; KSS -1610S, 5290S; PBR -BC1278; FLT -OP5261; HAF -HOF250; MNC -W71930; COO -Z1195, Z1758; SVA -SO592; TEF -PSL564

### Filters Cross Reference Chart

Part Number	Product Description	Potential OE Part Number	Potential Comp. Part Number
0986AF1043	Oil Filter Spin-on	TOY-9091503004, 1560016010, 9008091034, 0012000015, 0012000013, 9008091210, 90915YZZJ2, 1560001020, 0892202001, 90915YZZE2, 9091510004, 0892202002, 1560016020	SKR -C1140; VIC -C113; RYC -Z432; MN -W6109, W6101; DON -P502019; WFF -WZ432; HEG -H97W01; PUR -L14476, L14477
F002H20377	Oil Filter Spin-on	MRU-16510M82713, 16510M73080, 16510M82703, 16510M73010	
F002H23551	Oil Filter Spin-on	MHI-8200867976, 7700274177, 8671002274, 8200768927, 8200768913	
9451037446	Oil Filter Spin-on		MN -W9005
0986452003	Oil Filter Spin-on	NIS-15208EB70D, 15208EB70C, 15208BN300, 15208BN30A	UFI -2312700; GUD -Z123; PBR -BC1108, BC1131, BC1070; MOT -MFL207, FL332; UNO -C140; FRA -PH2879, PH16; ZF -9999000172; FLG -LF3400, LF3682, LF3501; NIP -J1312001; DON -P779150, P550095, LFP552518, P779220, P559957, P551201, P552518, P550882, P779221, P550963, LFP551201, LFP550882, LFP550095; FIM -FT4512; UNP -GFE8049, GFE221; AMK -TO130, KO5001; PUR -L10017, PC23; TEF -PSL171; VIC -C103; KSS -0500S; PRF -LS149; CRO -604, 5291, 615, 683; MN -W71280, WF9161, W71238, W92031, W92080, W92048, W92026; MHL -OC236; WIX -WL7067, WL7400, WL7113, WL7078, 51362; HEG -H10W11, H24W01; RYC -Z89A, Z135, Z10; FLT -OP562; KNE -AW45, AW6, OC36, FO383; MFR -ELH4244, ELH4385; COO -Z860, Z27A
F002H26361	Oil Filter Spin-on	TAE-252518130164	FLG -LF09667
F026407268	Oil Filter Spin-on	CIT-9809532380	HEG -H388W; MHL -OC1397; FRA -PH12221; MN -W7063; MQP -LVFL846; MSF -Z699; KNE -OC1397; PRF -LS995; CPF -FT6735; FLT -OP5403; MFR -ELH4478
9951030134	Oil Filter Spin-on	TAE-254718130117	

### Filters Cross Reference Chart

Part Number	Product Description	Potential OE Part Number	Potential Comp. Part Number
F002H23467	Oil Filter Spin-on	HON-15400PH1F03, 15400PR3014, 15400RAFT01, 15400PLC003, 15400PLC004, 15400RTA004, 15400PMET01, 15400RTA003, 15400P3RE01	
F002H23413	Oil Filter Spin-on	TOY-90915TB001	
F002H20236	Oil Filter Spin-on	TAE-254718130115	FLG -LF16070
F026407306	Oil Filter Spin-on	LEX-9091510009	LUC -LFOS344; MFR -ELH4512; MHL -OC534; DSO -FC1150107640, 1150107640; FLT -OP6182; MN -W6031; HEG -H97W07; WIX -WL7593; MSF -Z713
F026407142	Oil Filter Spin-on	HYU-2630003000, 2630003001, 2630002502, 2630002503	PRF -LS301; MHL -OC1566, OC1052; UFI -2345200; FLT -OP5952; HEG -H97W06; MQP -LVFL793; TEF -PSL166; MFR -ELH4440; MN -W7023; WIX -WL7520; GUD -Z580; KNE -OC1566, OC1052
F026407203	Oil Filter Spin-on	JAG-C2Z21964, C2Z32125	PRF -LS357; HEG -H90W27, H319W; UFI -2363200; MFR -ELH4369; FLT -OP5322; WIX -WL7510; MOT -EFL910, EFL907, FL910S; GUF -GFO157; GUD -Z586; FRA -PH9566, PH9460; MGA -FH1129; MHL -OC466, OC1063; TEF -PSL164; KNE -OC466, OC1063; CHA -C182; MN -W7015
F002H23470	Oil Filter Spin-on	HYU-2630002751, 2630002750, 2630002752	
F002H23439	Oil Filter Spin-on	MHI-9420000074, 9420000073, 0303BAM00350N, 0303BC0071N, 0303BC0010N, 0024772	
0451103370	Oil Filter Spin-on	OPE-93178952, 55352643, 93156300, 650144, 650104, 93156243, 55496757, 0650104, 0650401, 650381, 95509857, 5650343, 650401, 93183723, 0650144, 93179720	GUD -Z684; PRF -LS370; FRA -PH10008; FLT -OP5701; MOT -EFL257; MFR -ELH4342, ELH4120; ALC -SP1275; CMI -CDW11001, EOF002; MHL -OC4053; HEG -H90W03, H90W26; ACD -96879797, PF65; PUR -L19209; HEB -J1310900; UFI -2329900; COO -Z1641; CRO -2293; KNE -OC4053; VAO -586058; MGA -FH1098; WIX -WL7428; MQP -VFL532; CPF -FT5753, Z1641; MN -W71275
F002H20371	Oil Filter Spin-on	HYU-2630002750	
F002H23490	Oil Filter Spin-on	HYU-2630022800	
F026407183	Oil Filter Spin-on	SKO-03C115561H, 03C115561D, 03C115561E	CMI -EOF250; FLT -OP6412; PRF -LS391, LS391A; HEG -H314W01; GUD -Z567; UFI -2357300; MHL -OC5933; CPF -FT6035, FT6035A; MN -W71294; FRA -PH10757A

**Filters Cross Reference Chart**

Part Number	Product Description	Potential OE Part Number	Potential Comp. Part Number
F026407209	Oil Filter Spin-on	NIS-1520865F0D, 1520865F1B, 1520865F0C, 152089F600, AY100NS004, 152089F60A, 1520865FOA, 1520865F01, 1520865F00, 1520895FOA, 152083J400, 152081HC0A, 1520865FOE, 15208ED50A, 1520865F1A, A520865FOA, 1520865F0B, 1520865F10	CLF -DO853A, DO853; LUC -LFOS159; SFM -S3484R; LAT -H59; NIP -J1310500, J1311026, J1311022, J1311018; CPF -FT5368; VIC -C806, C224; FLT -OP595; MHL -OC1566, OC1052; UFI -2348400; MQP -VFL390; AHK -1001120, 1005593; GUD -Z653; MN -W671, W6025; KNM -RB197, RB222; AMK -NO2223, HO821; FRA -PH5594A, PH11275, PH4998, PH5594; FIM -FT5406, FT6081, FT5368; UNO -C218, C560; BLP -ADG02109, ADN12112; MSF -Z452; PUR -L18097; VAO -586022; TEF -PSL78; DEP -X597; KNE -OC1566, OC1052; WIX -WL7537, 51358; TEN -R205, R215, R438; PBR -BC1375; JPP -FO593S, JFO120S, FO120S, JFO197, FOH05S, JFO593S; PRF -LS301, LS965; SKR -C1855; HEG -H13W03, H313W, H97W06; FLG -LF3692; EOR -E149082; MFR -ELH4440, ELH4243
F026407203	Oil Filter Spin-on		PRF -LS357; HEG -H90W27, H319W; UFI -2363200; MFR -ELH4369; FLT -OP5322; WIX -WL7510; MOT -EFL910, EFL907, FL910S; GUF -GFO157; GUD -Z586; FRA -PH9566, PH9460; MGA -FH1129; MHL -OC466, OC1063; TEF -PSL164; KNE -OC466, OC1063; CHA -C182; MN -W7015
F026407332	Oil Filter Spin-on	HYU-2631027200	ACD -X4318E; MFR -ELH4416; LAT -H133; HEB -J1310512; WIX -WL7426; PRF -LS1067; HEG -H16W04; MHL -OC476; HFR -15519; UFI -2354500; MSF -Z185; JPP -FOH04U, JFOH04U; MYL -37143220004; MED -15519; CMI -CHY11002; MQP -VFL562; SFM -S3545R; KNE -OC476; ASU -03934050; NIP -J1310504; AHK -10H0004U; GUD -Z529; MN -W8303; CHA -COF100289S; BLP -ADG02116, ADG02126; EOR -1616174680; AMK -HO609; MAR -154068223810; ALC -SP1274; FLT -OP6325
F002H24495	Oil Filter Spin-on	TAE-570518130102	
F026407181	Oil Filter Spin-on	VWW-03C115561J, 03C115561C, 03C115561B	PRF -LS391, LS391A; MN -W71293; GUD -Z579; CPF -FT6035A; WGA -WO342; UFI -2349400; MHL -OC5934; HEG -H312W01; FLT -OP6411; FRA -PH11820, PH10757A; CMI -EOF226

**Filters Cross Reference Chart**

Part Number	Product Description	Potential OE Part Number	Potential Comp. Part Number
0986452036	Oil Filter Spin-on	HON-15400PR3406, 15400MJO003, 15400PT7005, 15400PC6004, 15400PT7006	WIX -WL7107; FRA -PH2849, PH3917HON, PH2871, PH6811, PH5343, PH2871MAZ, PH3917; MOT -EFL320, EFL129, FL821, EFL361, EFL296, EFL383, EFL487, EFL319, EFL130, EFL314; ALC -SP919, SP934, SP873; THK -116182, 115522; DON -P552840, P779164; PRF -LS460, LS489, LS705, LS489A; CRO -6728, 2071, 662, 672, 2025, 2065; THO -4144; CHA -F110, F302, F208, F116, F126; MN -W81480, MW810, W6102; AL -AL73, AL304; RYC -Z79A, Z142A, Z148A; AMK -FO011A, MO526, MO422, HO818, MO523, CY003, HO523, MO520, MO429, HO819; MHL -OC115; FLT -OP623, OP5581, OP557; KSS -1460S; WFF -WZ148A; CLF -DO883, DO289, DO324; VIC -C414, C304, C403, C805; GUD -Z218; FLG -LF3536, LF3462, LF3591; UFI -2324300, 2313300, 2310300; FIM -FT4907, FT5148, FT5407, FT4908HON, FT4908, FT4911, FT4907MAZ, FT5216; TEN -R94, R96; COO -Z527, Z91, Z920, Z91B; MFR -ELH4143; NIP -J1313016, J1313002, J1313001, J1314006, J1314004; ACD -X119, X46; PUR -PER4458, L14459, L14610, L20073, L10241, L24458; APD -LK1191, LK1080A, LK1080, LK3837, LK1080B, LK1016; KNE -OC115, OC194; PBR -BC1287, BC1318, BC1090, BC1088; HEG -H97W02, H90W25, H13W01
0451103313	Oil Filter Spin-on	SKO-078115561J	HEG -H24W04; LUB -LS210, PH2701; UFI -2346500, 2346540; COO -Z1417; ALC -SP979; CMI -EOF047; MFR -ELH4280; PUR -L30257, L25401; MPC -61200; CRO -2200; DEP -FX20017, FX20002, FX0131; WIX -WL7321, WL7072; WGA -WO344; MN -W93021, W93019; FRA -PH8994; LAT -ELH4280; FIM -FT5567, FT5363; ACD -FX20017, X4085E; SFM -S6620R; GUD -Z358; FLT -OP5265, OP5262; TEN -R266, R299; MHL -OC485, OC241, OC311; KNE -OC485, OC241, OC311; PRF -LS214, LS274, LS274A; KSS -3500S, 5140S; CLF -DO896





# What drives you, drives us

Bosch technologies are used in most vehicles worldwide.  
People, and assuring their mobility, is what we are focused on.

Therefore, we have dedicated over 130 years of pioneering spirit  
and expertise in research and manufacturing to achieving this.

We provide the aftermarket and workshops worldwide with modern diagnostic  
and workshop equipment and a wide range of spare parts for passenger cars and  
commercial vehicles:

- Solutions for efficient vehicle repairs
- Innovative workshop equipment and software
- One of the world's most comprehensive ranges of new and exchange parts
- Large network of wholesale customers, for quick and reliable parts supply
- Competent hotline support
- Comprehensive educational and training offers
- Targeted sales and marketing support

Scan the below QR code to place your  
orders on the Bosch Infocomm App



Please contact your nearest Bosch Main Distributor to enroll in the  
Bosch Rewards Programme / register in the Bosch Infocomm App



**Bosch Limited**  
**Automotive Aftermarket**  
P. B. No: 3000, Hosur Road, Adugodi  
Bengaluru – 560 030