



BOSCH

Invented for life

Driven by

HAIRPINS

**Reliability in
any situation**
Brakes from Bosch

Because safety is more than a feeling

Brakes from Bosch



Did you know?

Safety without compromise:

Brakes from Bosch bring a vehicle traveling at 100 km/h to a standstill in approx.

2.7 seconds

The child should not really have been riding her go-kart in the driveway. Coming around the tight corner, she only came into view at the last moment. But the father behind the wheel stops the family station wagon in time. Like him, drivers all over the world rely on brakes and brake components from Bosch. Displaying technology and quality, they set standards and make essential contributions to safety in road traffic.



Parts, diagnostics and services

The range for the aftermarket and workshops comprises high-quality spare parts, modern workshop equipment for diagnostics, service and repairs, as well as special training offers and a technical hotline. Accordingly, Bosch offers a very comprehensive package to facilitate everyday work routines in workshops.



Global presence

More than 17,000 associates in 150 countries, together with an extensive dealer network, reliably ensure targeted workshop support and local availability of the Bosch spare parts range.



Competence and know-how

Thanks to decades of experience and a comprehensive system expertise, Bosch knows the technical requirements of automobiles very well. Bosch brake components benefit from this know-how. Bosch provides reliable solutions meeting the technical requirements and standing out for their high quality.



Committed to progress

Bosch has made an essential contribution toward advancing technical progress in brake technology. With its own research and development facilities, Bosch continues to ensure that brakes and therefore driving are safer than ever before.



0.72
m

Because safety is more than a feeling

Brakes from Bosch

The child should not really have been riding her go-kart in the driveway. Coming around the tight corner, she only came into view at the last moment. But the father behind the wheel stops the family station wagon in time. Like him, drivers all over the world rely on brakes and brake components from Bosch. Displaying technology and quality, they set standards and make essential contributions to safety in road traffic.



Parts, diagnostics and services

The range for the aftermarket and workshops comprises high-quality spare parts, modern workshop equipment for diagnostics, service and repairs, as well as special training offers and a technical hotline. Accordingly, Bosch offers a very comprehensive package to facilitate everyday work routines in workshops.



Competence and know-how

Thanks to decades of experience and a comprehensive system expertise, Bosch knows the technical requirements of automobiles very well. Bosch brake components benefit from this know-how. Bosch provides reliable solutions meeting the technical requirements and standing out for their high quality.



Committed to progress

Bosch has made an essential contribution toward advancing technical progress in brake technology. With its own research and development facilities, Bosch continues to ensure that brakes and therefore driving are safer than ever before.



Global presence

More than 17,000 associates in 150 countries, together with an extensive dealer network, reliably ensure targeted workshop support and local availability of the Bosch spare parts range.



Did you know?

Safety without compromise:

Brakes from Bosch bring a vehicle traveling at 100 km/h to a standstill in approx.

2.7 seconds



Did you know?

With an engine output of 200 horsepower, braking horsepower is about five times as high:

1,000 hp!

Brake components

Overview

Ever since automobiles have featured brakes, there has been a need to make them safer and more efficient. Bosch has been committed to technical progress right from the start in an effort to provide drivers with improved braking safety and comfort.

Brake experts for more than 90 years

Bosch is a key pioneer in brake technology, presenting the first servo brake as early as 1927. Brake technology continues to be characterized by many technical developments by Bosch.

Extensive product range

The Bosch range of brakes comprises more than 50,000 different products around the world. Whether wear parts, hydraulic products or components for electronic brake systems – Bosch supports workshops with an extensive range of products. With more than 15,000 sets of brake pads, Bosch covers more than 97% of the market in Europe alone. This makes it possible for workshops to work efficiently and competitively on the brake systems of a wide variety of vehicles.

Safe and reliable

Bosch is among the leading international manufacturers of brake system components. Brake pads are produced in line with the most stringent quality guidelines in Bosch production facilities in Juárez (Mexico) and Shanghai/Nanjing (China). Specially tailored to the respective vehicle models, Bosch engineers develop new brake pad mixtures in their development laboratories in Karlsruhe (Germany) and Chicago (USA).

Bosch – a strong partner for workshops

Bosch is a strong partner supporting workshops – in order to keep customers satisfied and improve their profitability. Bosch offers a wide range of services comprising first-class products, reliable service offers, and efficient diagnostics technology for the workshop business.



Brake components

Product range



Wheel brake

- ▶ Brake discs
- ▶ Brake pads
- ▶ Warning contacts
- ▶ Brake pad accessories
- ▶ Brake calipers/
Remanufactured brake calipers
- ▶ Brake caliper repair sets
- ▶ Brake drums
- ▶ Drum brake shoes
- ▶ Wheel brake cylinders
- ▶ Drum brake shoe accessories
- ▶ Pro drum brake shoe kit
- ▶ Super Pro drum brake shoe kit



Transmission equipment

Very high safety and consistent transmission behavior

- ▶ Brake hoses
- ▶ Brake cables
- ▶ Brake fluids
- ▶ Superfit lubricant



Actuation equipment

Reliable braking thanks to high-grade materials, stringent quality control and a carefully matched system for all actuation components

- ▶ Brake master cylinders
- ▶ Brake boosters
- ▶ Brake force regulators



Brake fluids

Product range and details



	ENV4	ENV6
	<p>ENV4 is an elite DOT 4 brake fluid. Improved safety in road traffic is achieved by a significantly higher dry and wet boiling point and lower viscosity. Higher boiling points offer additional protection from the formation of vapor bubbles in the fluid at excessively high brake temperatures which can cause brakes to fail in extreme cases.</p>	<p>Bosch ENV6 sets new standards for DOT 4 brake fluids. It can replace all previous brake fluids (applies for vehicle models launched since 1990) and reduces complexity in the workshop. Improved safety is offered by a significantly higher dry and wet boiling point which exceeds all Bosch brake fluids to date, accompanied by extremely low viscosity. The latest ABS and ESP® systems benefit from outstanding lubrication levels at low temperatures.</p>
Dry boiling point (°C)	≥ 265	≥ 270
Wet boiling point (°C)	≥ 175	≥ 180
Viscosity at -40 °C (mm ² /sec)	≤ 700	≤ 670
DOT types	DOT 4, DOT 4HP	DOT 3, DOT 4, DOT 5.1
Areas of application		

Advantages at a glance

- ▶ Fast and safe braking
- ▶ High vehicle stability even for reactive braking
- ▶ OE brake fluid of high quality
- ▶ Suitable for all standard vehicles (DOT 3, DOT 4, DOT 5.1 with or without ABS/ESP®)
- ▶ New OE standard for some vehicle manufacturers and Bosch system development
- ▶ Longer maintenance intervals can be achieved

ENV6 brake fluid

Product details

Highly-dynamic brake fluid for high loads – with its low viscosity and high wet boiling point, ENV6 already meets the requirements of future brake systems today.



Advantages at a glance

- ▶ **One for all:** suitable for all standard vehicles (DOT 3, DOT 4, DOT 5.1 with or without ABS/ESP®)
- ▶ **Fast and safe braking:** exceeds all of the respective brake fluid standards
- ▶ **High performance:** ENV6 is the new standard at Bosch for current and future developments of new brake technologies
- ▶ **High vehicle stability even for reactive braking:** the high-quality and viscose fluid ensures optimal response by the ABS and ESP® system
- ▶ **Longer maintenance intervals:** can be achieved by the high specifications (a brake fluid tester in the workshop helps in examining the boiling points)
- ▶ **Long storage capacity (min. 5 years when sealed well):** the tinplate packaging provides the brake fluid with extra protection against water absorption
- ▶ **Protects ABS and ESP® from wear and corrosion:** thanks to high lubricity of the brake systems

ENV6 brake fluid

Quality tests

Sophisticated test at the Bosch development center

For more than 2 years, Bosch ENV6 has been tested and geared to new versions of the ABS and ESP® systems at the Bosch test-bench laboratory.

The Bosch ENV6 brake fluid has been subject to extreme strains both at the test routines regarding the system-pressure build-up at extreme temperatures and at the wear and noise tests.



Bosch ENV6 test results at the laboratory: At the Bosch development center, the brake fluid is subject to chemical tests.



Continuous-operation test benches at the high-tech laboratory: With its high dynamic, ENV6 contributes to the high performance and service life of modern brake systems.



Comparing viscosity and wet boiling point of different brake fluids

Viscosity [1/mm²/s]

The higher the viscosity, the shorter the reaction times of ESP®.

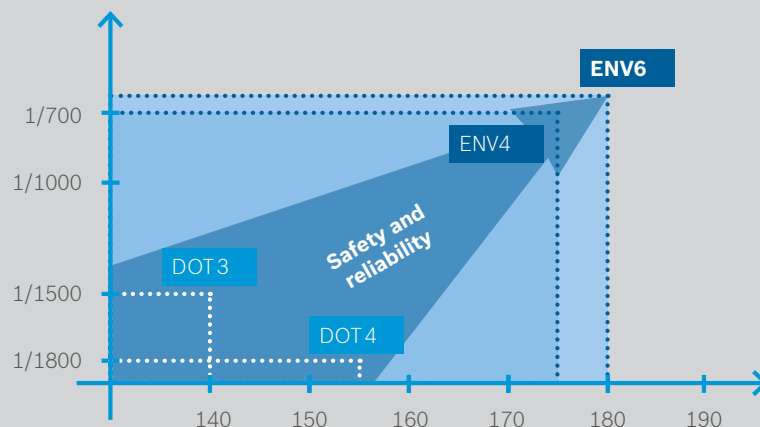

High wet boiling point [°C]

The higher the wet boiling point, the lower the risk of formation of vapor bubbles – the main cause of brake failure.

Superfit high-performance lubricant

Product details

The permanent lubricant **Bosch Superfit** prevents brake noises. Bosch Superfit also ensures a long and reliable service life.



Advantages at a glance

- ▶ **Long-term durability:** through low oil separation
- ▶ **Outstanding function:** as lower tendency to collect dust (pasting) than comparable products
- ▶ **High durability:** through outstanding resistance to heat arising during braking
- ▶ **High thermal range:** as it is insensitive to both high and low outdoor temperatures
- ▶ **Non-corrosive:** Bosch Superfit is metal-free, acid-free and non-conductive
- ▶ **Outstanding interaction:** Bosch Superfit is also well suitable for steel/aluminum brake calipers



Workshop tip

Assembly with lubricants containing copper can lead to resonant vibrations and/or make it more difficult for the brake pads to return smoothly once the brake is released. Both of these can result in noise (squealing).

By using Bosch Superfit in the area of the brake pad guides and – depending on the caliper design – the brake caliper guides as well, such noises can be avoided and improved sliding properties of the brake pads achieved.

Brake discs

Overview and product details

Bosch has comprehensive competence and many years of experience in the development and manufacture of brake discs and is a key OE partner to the automotive industry. Bosch expertise is applied as early as in the selection of materials. It ensures products of the highest quality which set standards in the market and convince workshop customer.

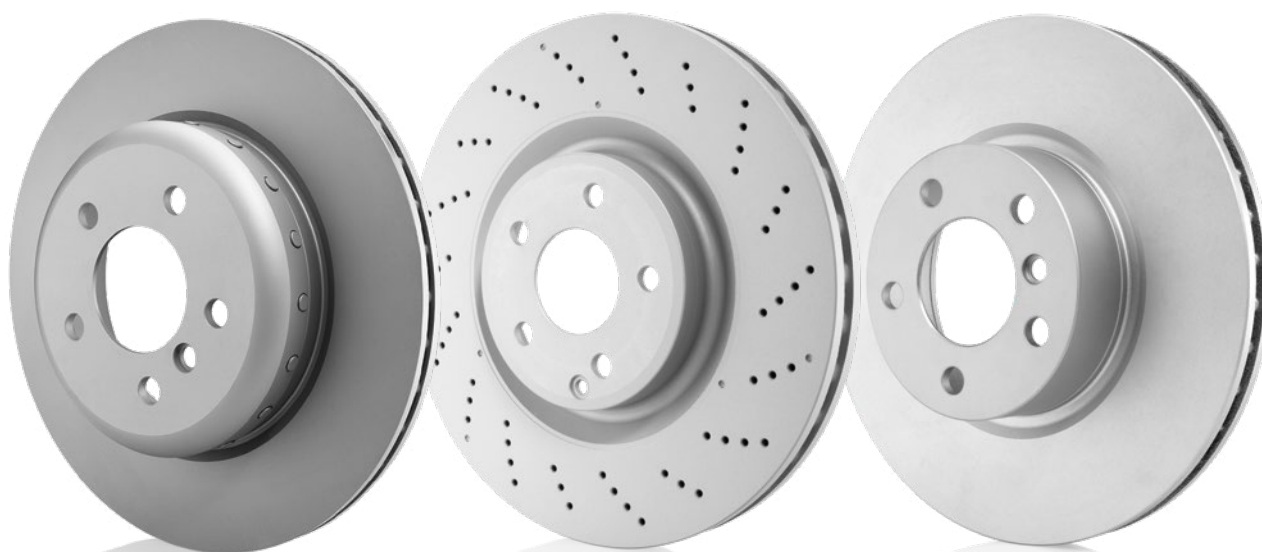

Advantages at a glance

- ▶ **Durable even in extreme situations:** through top braking performance and comfortable, safe braking characteristics
- ▶ **Braking without noises or vibrations as well as improved and long-term driving comfort:** through minimum manufacturing tolerances and the use of innovative alloyed and high-carbon cast materials
- ▶ **Efficient and swift repairs:** through enclosed fixing screws, integrated wheel bearings and ABS sensor rings
- ▶ **Corrosion-protected:** through innovative brake disc coatings
- ▶ **Bosch quality:** the Bosch Group is Europe's largest OE/OES manufacturer of brake discs for passenger cars

Composite brake discs

Product details

The Bosch composite brake disc is an innovative, lightweight product development which comprises a profiled aluminum mount paired with a cast brake ring made from high-carbon gray cast iron. The material composition and tolerance values are specially matched with the respective brake system in the applications covered.



ECE-R90-
certified



Advantages at a glance

- ▶ **Weight reduction of up to 20 %:** ensures reduced fuel consumption and CO2 savings
- ▶ **High degree of comfort and excellent driving performance:** the lighter brake disc concept reduces the un-sprung mass of the braking system
- ▶ **Minimized brake judder:** through higher thermal performance and improved conductivity accompanied by higher dimensional stability of the friction ring under thermomechanical loads
- ▶ **Counteracting vibrations and noises:** through the decoupling process of the friction ring and the aluminum mount
- ▶ **Minimized tension and thermal cracks:** by using a bi-metal product with a special bonding process, heat flow separation is achieved from the wheel hub
- ▶ **High resilience and good deceleration characteristics:** performance is improved by the innovative design and high-quality materials of the brake disc

Brake discs

Technology

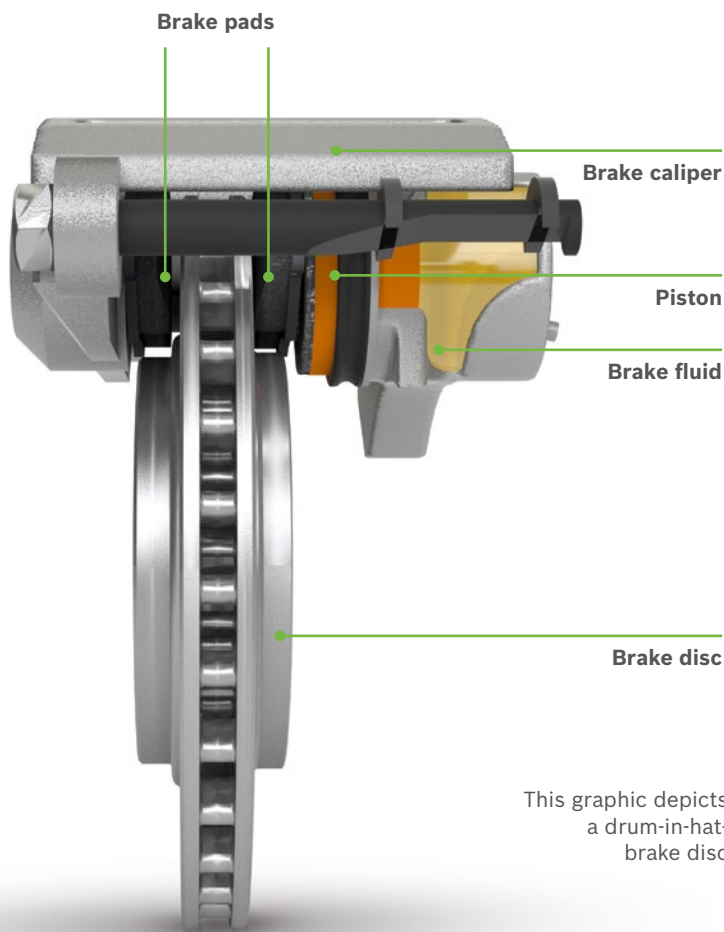

This graphic depicts a drum-in-hat-brake disc

Disc brakes comprise:

- ▶ Brake disc firmly connected to the wheel
- ▶ Brake bracket for securing the brake caliper
- ▶ Brake caliper
- ▶ Brake pads

Specially matched with each other: the brake components

Bosch develops and manufactures disc brakes. Brake disc, bracket, caliper and pads are specially matched with each other and comply with the exact requirements of the respective vehicle model. This ensures top performance in terms of:

- ▶ Brake efficiency
- ▶ Service life
- ▶ Brake comfort



Cast steel – safe, perfect, proper

Higher engine performance and vehicle weights make increasing demands on the brake system. Only brake discs made from high-grade materials and homogenous cast structure without internal tension comply with the vehicle manufacturers' specifications.



Uncompromising precision: high carbon

High-carbon discs made from a highly-carbonized gray cast iron dissipate heat without thermal cracks or distortions. This prevents the brakes from juddering, improves deceleration, and increases both the resistance and service life of the brake discs.

**HIGH
CARBON**

Brake discs

Maintenance

No tolerance without tolerances

Two characteristics are crucial to the quality and thus the performance and comfort of a brake disc: the side runout, i.e. the parallel state of the friction ring to the area of support, and the degree of unevenness, i.e. the parallel state of the friction ring surfaces. Bosch brake discs are distinguished by a very high degree of precision. Why? Bosch has outstanding expertise and extensive experience with respect to casting technologies at its disposal.

Always replace in pairs

Brake discs are subject to wear and should always be replaced in pairs per axle as soon as one of them drops below the minimum thickness. This usually occurs with the second brake pad replacement or the third at the latest.

Who needs brake judder and squeals?

Nuisances such as brake judder or squealing are usually caused by irregularities on the brake disc surface or by a side runout of the disc. However, excessive slackness in the wheel bearings, the wheel suspension and even in the steering transmission components can be a factor, too. Professional repairs and the use of high-quality spare parts eliminate these nuisances.



Workshop tip

Prior to assembling the brake discs, the surface areas of the wheel hub must be clean, free of rust and burrs, and even and should not display any indications of damage.



Workshop tip

In the case of composite brake discs, the vehicle-specific rated torque is achieved in three steps during wheel assembly:

Tighten wheel bolts crosswise:

1. Turn in evenly (max. 20 Nm)
2. Tighten to 2/3 of the rated torque
3. Use torque wrench to tighten to rated torque as per vehicle manufacturer's specifications

For caliper assembly or pad changes, the lock angle may only be achieved using the steering wheel. Avoid straining the disc.

Brake pads

Product details

Top braking performance is achieved by selecting premium materials and consistent testing of the pads. Research, development and production in the quality-certified plants ensure the high quality demands offered by Bosch brake pads.



Advantages at a glance

- ▶ **Safe and reliable:** Bosch tests exceed all statutory requirements
- ▶ **Consistent brake performance even under high loads:** ensured by a stable friction value
- ▶ **Braking without noises or judder:** through anti-vibration plates, chamfered edges
- ▶ **Comfortable and good pedal feel:** ensured by high compressibility
- ▶ **Always the right pad for the respective vehicle** selected by Bosch experts
- ▶ **Bosch quality:** from international research and development



Did you know?

Mount brake pads correctly to avoid brake noises:

- ▶ Prior to assembly, lubricate the brake pad guides and brake caliper guides (depending on the model) with Bosch Superfit 5 000 000 150
- ▶ **Do not lubricate** brake pads which have an adhesive layer
- ▶ **Do not use** lubricants **containing copper**
- ▶ Replace accessory parts, springs, clips etc.

Brake pads

Technology

Friction material

Is developed individually for each vehicle and taking consideration of the material properties of the brake disc, thereby ensuring very short stopping distances and excellent comfort.

Intermediate layer

Is responsible for comfort and safety, and has an influence on compressibility and noise.

Adhesive

Ensures the connection between the pad carrier and friction material, which means it provides the required shearing strength, thereby ensuring that the friction material does not detach from the pad carrier even under extreme conditions.



Anti-vibration material

Insulating coating made of rubber, plastic or metal (shim) for improving the comfort features.

Pad carrier

Ensures a safe function in the interaction between the brake caliper and brake piston and is coated with high-grade, environmentally friendly varnishes to avoid corrosion.

Did you know?

Several US states will be specifying copper-free brake pads in the future in order to protect the environment. Bosch has already responded by registering the patent for the copper-free NAO brake pad mixture as early as 2014.



Bosch quality requirements

The ECE R90 quality standard represents the European guideline for approving disc brake pads and drum brake shoes. Brake pads from Bosch by far exceed statutory standards.



Brake pads

Quality tests



Bosch's global brake development and manufacturing network:

- ▶ Chicago, USA (development)
- ▶ Juárez, Mexico (production)
- ▶ Karlsruhe, Germany (development headquarters)
- ▶ Shanghai/Nanjing, China (development/production)

Quality without compromises

Bosch brake pads are distinguished by their high quality which is comparable to that of original equipment. They are designed for extreme loads and are made of particularly high-grade materials. Before entering the market, they are obliged to prove their resilience and long service life within the framework of comprehensive tests.



Bosch brake pad tests are tougher than those specified by ECE R90

Tests specified in accordance with the ECE R90 standard applicable in Europe	Tests specified by Bosch
▶ Shearing strength	▶ Shearing strength
▶ Pressure sensitivity	▶ Pressure sensitivity
▶ Speed sensitivity	▶ Speed sensitivity
▶ Temperature resistance	▶ Temperature resistance
	▶ Temperature sensitivity
	▶ Brake fading
	▶ Thermal conductivity
	▶ Brake judder
	▶ Noise
	▶ Wear
	▶ Simulation of extreme braking situations

Brake hoses

Product details

Flexible safety rear to front: The high quality of Bosch brake hoses pays off.



Advantages at a glance

- ▶ **Bosch brake hoses cope with high mechanical strains and are resistant to chemical influences**
- ▶ **They comply with the technical regulations (e.g. FMVSS 106)**
- ▶ **Durable and safe:** due to use of high-quality materials and modern production techniques
- ▶ **Easy and precise installation:** due to accurately fitting design and fittings



Workshop tip

Ambient humidity can penetrate porous or defective brake hoses. This affects the brake performance – and can even result in complete failure. **Brake hoses should thus be subject to a visual examination at each technical service and replaced in case of damage or severe corrosion.**

Brake hoses

Technology

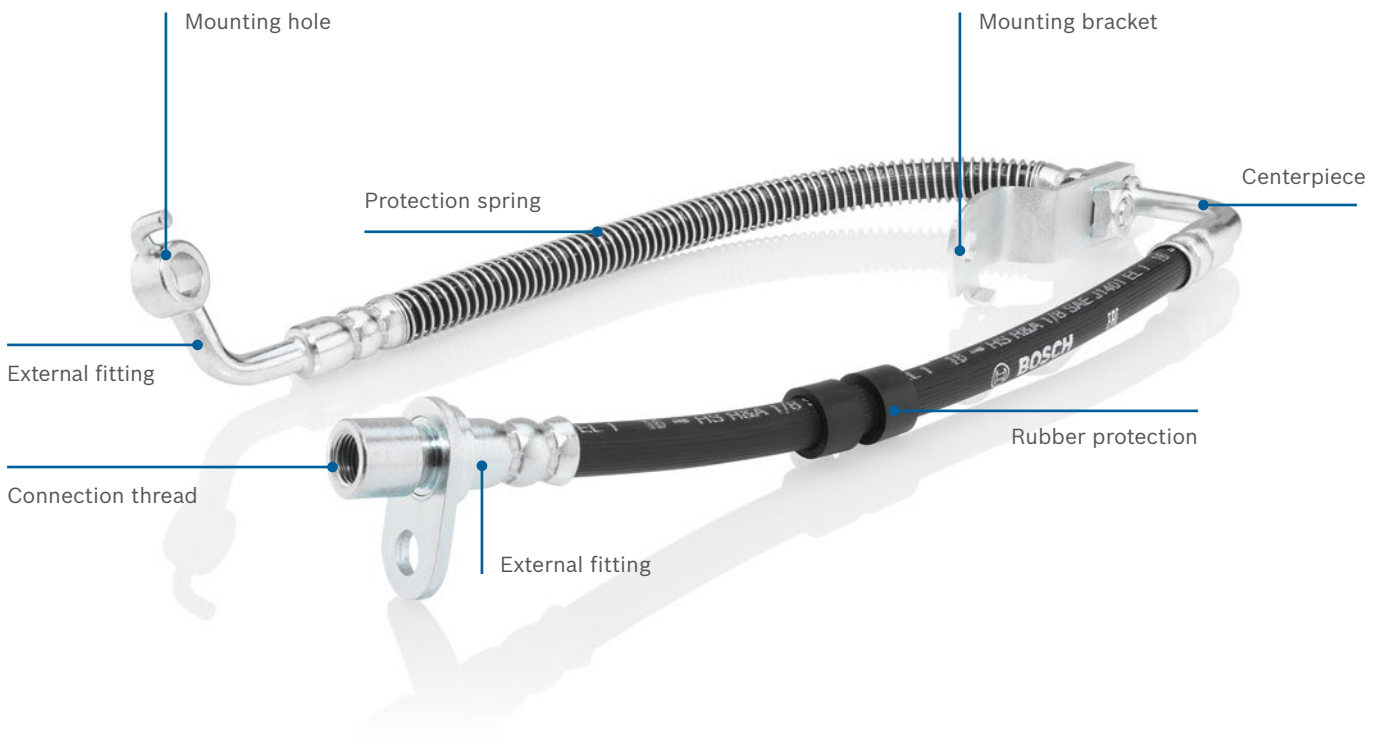

Car driver safety through high quality

Bosch brake hoses are available with cold-rolled or CNC-machined fittings. If necessary, Bosch brake hoses come with protective rubber cover and cable holder installed at the right place.

Bosch brake hoses are subject to tough tests:

- ▶ Pressure test at the end of assembly
- ▶ Expansion test
- ▶ Burst test
- ▶ Tensile strength test (slow and quick pulling)
- ▶ and several additional quality tests in line with the guidelines FMVSS 106, SAE J1401 and GB 16897

Brake hoses

Maintenance

Causes of defects

- ▶ High mechanical strains
- ▶ Climatic influences such as humidity, road salt, oil, ozone and other chemical substances
- ▶ Material aging
- ▶ Short pressure peaks of up to 180 bar within the brake system
- ▶ Incorrect installation
- ▶ Mechanical influences of accidents, marten bites or the like

Identifying defective brake hoses

- ▶ Reduced brake performance until total failure
- ▶ Brake fluid leaks
- ▶ Corrosion on brake lines
- ▶ Visibly or perceptibly porous or damaged brake hose

Regular testing at the workshop

- ▶ Visual examination at any technical service
- ▶ It is usually easy to identify cracks, lumps and other external damages



Corroded brake hose



Brake hose with breakaways



Porous brake hose



Brake hose with breakaways



Workshop tip

- ▶ Fit hoses free of tension, twists or contacts
- ▶ Ensure a bending radius big enough (> 40 mm)
- ▶ Do not bring in contact with greases oils or other chemical substances
- ▶ Do not install next to the exhaust system



Brake cables

Product details

Bosch brake cables reliably transmit the brake force of the parking brake to the wheel brakes of the rear axle. **High-quality materials provide tear and wear safety.**



Advantages at a glance

- ▶ **Easy to install:** as all cables are geared to the respective vehicle
- ▶ **Reduced wear and tear:** due to use of high-quality materials with high strength
- ▶ **Safe parking:** new Bosch brake cables are maintenance-free and ensure good functionality



Workshop tip

Dirt, wear and corrosion can cause the brake cable to get stuck thus impeding its optimum actuation. This will affect the functionality of the parking brake. **Brake cables should thus be checked regularly and replaced if required.**

Brake cables

Technology

Extruded inner hoses
ensure minimum friction
and a long service life

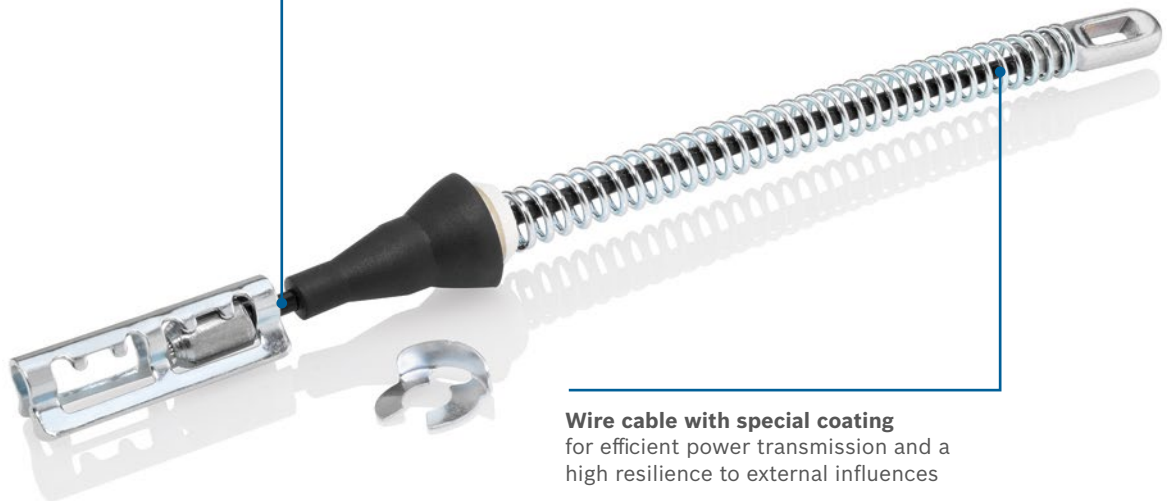

Wire cable with special coating
for efficient power transmission and a
high resilience to external influences



Did you know?

The Bosch range of brake cables covers
more than

95 %

of the complete European vehicle market.

Bosch brake cables are subject to tough tests:

- ▶ Saltwater spray (OE-standard test)
- ▶ Performance tests (OE-standard test)
- ▶ Temperature resistance (OE-standard test)
- ▶ Material fatigue in case of load cycling operation (OE-standard test)

Brake cables

Product details and technology

Bosch brake cables reliably transmit the brake force of the parking brake to the wheel brakes of the rear axle. For quick and safe installation, they come pre-assembled. **High-quality materials provide tear and wear safety.**

Extruded inner hoses
ensure minimum friction
and a long service life

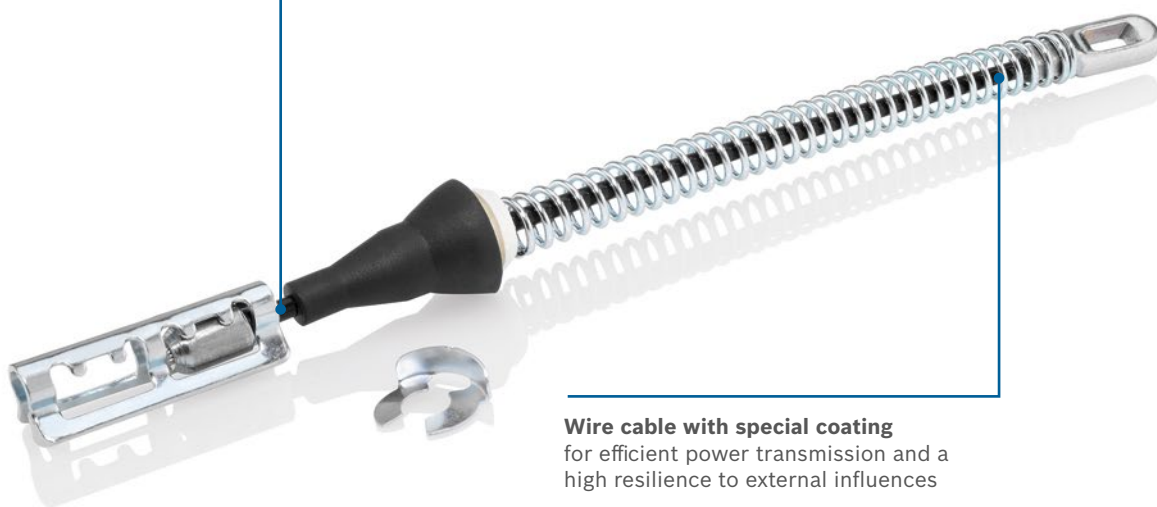

Wire cable with special coating
for efficient power transmission and a
high resilience to external influences



Advantages at a glance

- ▶ **Easy to install:** as all cables are geared to the respective vehicle
- ▶ **Reduced wear and tear:** due to use of high-quality materials with high strength
- ▶ **Safe parking:** new Bosch brake cables are maintenance-free and ensure good functionality



Workshop tip

Dirt, wear and corrosion can cause the brake cable to get stuck thus impeding its optimum actuation. This will affect the functionality of the parking brake. **Brake cables should thus be checked regularly and replaced if required.**

Brake cables

Maintenance

Causes of defects

- ▶ Mechanical strains
- ▶ Climatic influences such as humidity, road salt, oil, ozone and other chemical substances
- ▶ Material aging
- ▶ Incorrect fitting
- ▶ Parking brake locking
- ▶ Use of grease on cable

Identifying defective brake cables

- ▶ Low resistance or parking brake rotating without engaging
- ▶ Long travel when actuating the parking brake
- ▶ Parking brake lever can be pulled up all the way to the stop
- ▶ No brake performance

Checking rear-axle brakes on a brake tester

- ▶ No brake performance with the parking brake lever pawl locked at the first tooth of the ratchet mechanism
- ▶ Different brake performance on each side
- ▶ Parking brake needs to be able to lock all wheels
- ▶ Parking brake lever travel must not be too long



Workshop tip

- ▶ Fit cables free of tension, twists or contacts
- ▶ Adjust for optimum function without scrubbing
- ▶ Do not install next to the exhaust system



Corroded and tight brake cable



Torn brake cable

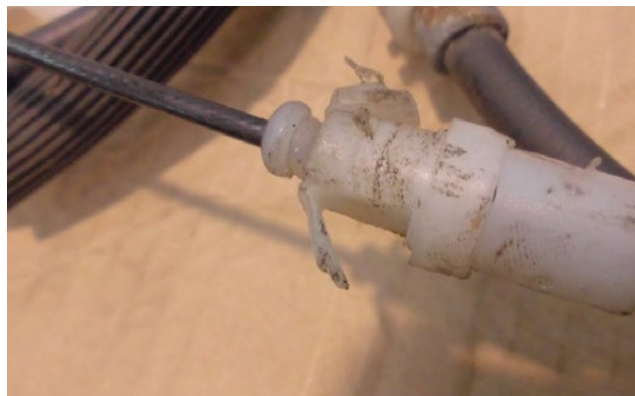

Incorrect installation



Torn brake cable

What drives you, drives us.

Bosch technologies are used worldwide in almost all vehicles. People, and assuring their mobility, is what we are focused on.

Therefore, we have dedicated the last 125 years of pioneering spirit and expertise in research and manufacturing to achieving this.

We continue to work on our unique combination of solutions for spare parts, diagnostic devices, workshop equipment and services:

- ▶ Solutions for efficient vehicle repairs
- ▶ Innovative workshop equipment and software
- ▶ The world's most comprehensive range of new and replacement parts
- ▶ Large network of wholesale customers, for quick and reliable parts supply
- ▶ Competent hotline support
- ▶ Comprehensive educational and training offers
- ▶ Targeted sales and marketing support

Find out more at:
bosch-automotive-aftermarket.com

Your local retailer:

Robert Bosch GmbH
Automotive Aftermarket

Auf der Breit 4
76227 Karlsruhe
Germany

www.bosch.com