



BOSCH

Invented for life

Driven by

ROBUSTNESS

**Reliable Service Parts
for Truck Business**
Commercial Vehicle
Filters from Bosch

Commercial vehicle filters

Overview

Commercial vehicles make money every day. Their operation is a constant race against the clock. Operators seeking to avoid expensive downtimes don't make any compromises and thus rely on Bosch commercial vehicle filters.

Safety through outstanding product quality

High-quality materials, neat and accurate processing and well-defined quality checks – according to the same standards as for OE parts.

Injection system competence

Bosch develops and produces diesel and Denox-tronic injection systems and therefore knows how to protect them.

Complete range from a single source

Easier handling and ordering thanks to a comprehensive range for many common types of commercial vehicles and engines, which is permanently updated.

High availability of goods

Bosch ensures quick availability of its parts by means of an international sales and logistics network.

Strategic partner for the future

Suitable diagnostic solutions, training courses and seminars for wholesalers and workshops.



Commercial vehicle filters

Product range

			
<p>Diesel filter</p> <p>Bosch diesel filters protect the injection system. They reliably separate particles and water from fuel and contribute to optimum engine performance.</p>	<p>Oil filter</p> <p>Bosch oil filters protect the engine and engine components - e.g. the turbocharger. They reliably separate soot and metal abrasion from engine oil.</p>	<p>Air filter</p> <p>Bosch air filters protect the engine and support a proper function of the sensors in the intake air duct. They reliably separate particles from intake air and contribute to optimum engine performance.</p>	<p>Cabin filter</p> <p>Bosch cabin filters protect the vehicle occupants against pollen, fine dust as well as harmful and foul-smelling gases.</p>
			
			
<p>Air dryer cartridge</p> <p>Bosch air dryer cartridges protect pneumatic systems of commercial vehicles against damages, e.g. the braking system. They dehumidify compressed air and reliably separate particles and oil mist thus reducing the risk of expensive downtimes.</p>	<p>Denoxtronic filter</p> <p>Bosch Denoxtronic filters protect the Denoxtronic injection system. They reliably remove particles from AdBlue thus contributing to optimum dosing.</p>	<p>Special filters</p> <p>Special filters for special tasks – from coolant filters to oil mist separators and hydraulic oil filters.</p>	
			

Commercial vehicle filters

Quality requirements

Product quality is not negotiable; there can't be any compromises in this regard. Besides high-quality materials and excellent processing, this includes optimized alignment of the filter specifications. These specifications influence one another. They must thus be exactly geared to each other in order to ensure outstanding filter performance.

All functional and quality tests are performed according to the same standards applied to original equipment parts.



Magic triangle of filtration

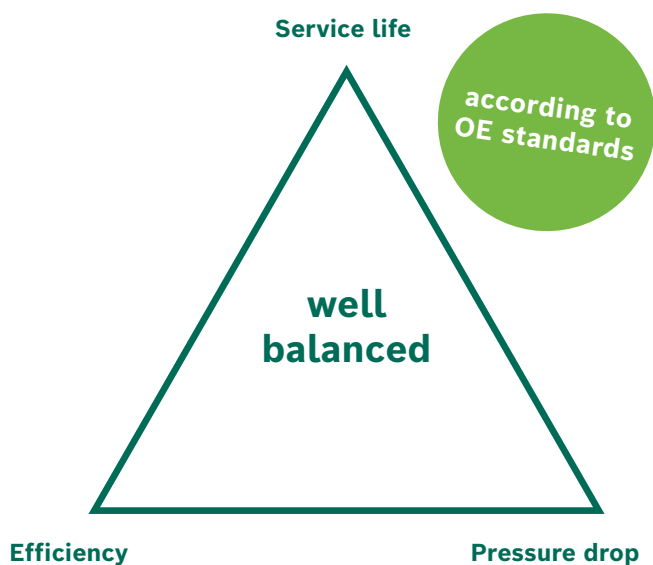

Service life (particle holding capacity):

the amount of particles a filter is able to retain before reaching the change interval – should be as high as possible

Efficiency (particle separation rate):

the ratio of the number of particles retained by the filter to the number entering the filter, expressed as a percentage – should be as high as possible

Pressure drop (differential pressure):

the difference in fuel/oil/air pressure between filter inlet and outlet – should be as low as possible

Commercial vehicle filters

Quality requirements

Commercial vehicles are almost always on the road. This means all filter types are constantly strained and – in case of international transport – it also implies significant variations in fuel quality in different countries. As a result, commercial vehicle filters need to meet technical requirements being appr. two to three times higher than those placed on passenger car filters.

Technical requirements* of passenger car and commercial vehicle oil filters in comparison (schematic illustration)

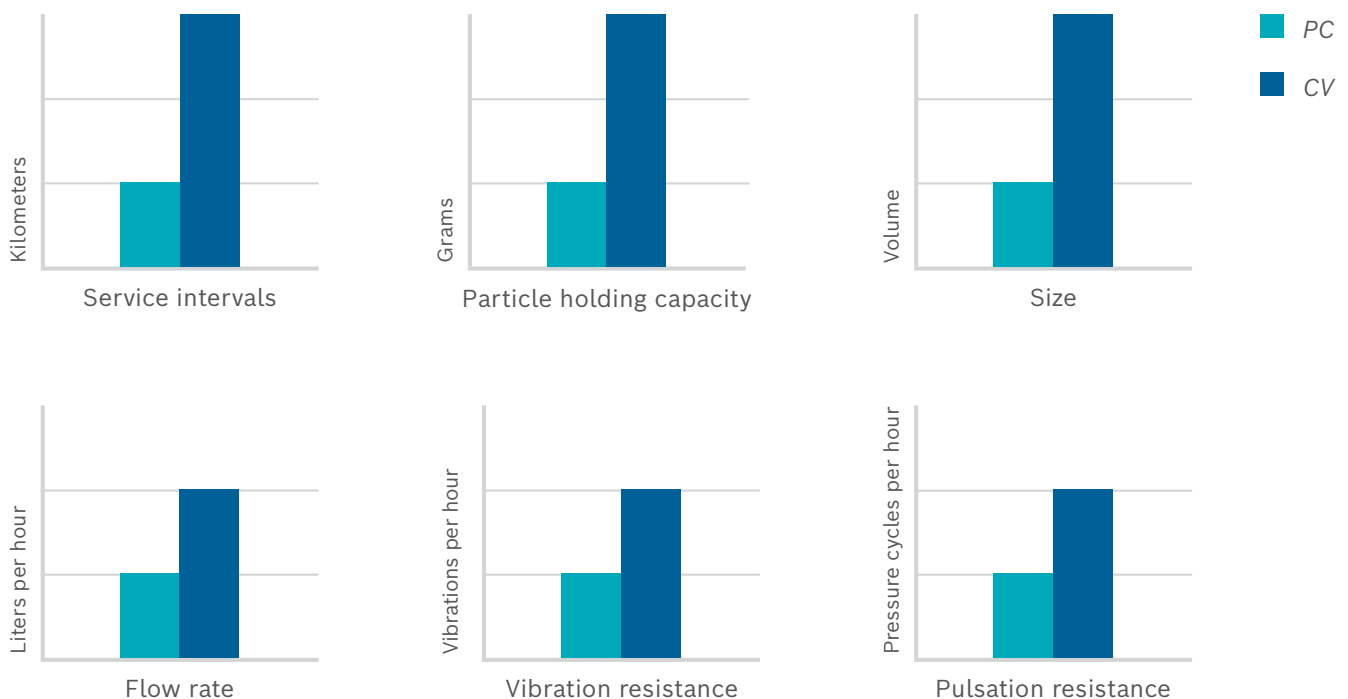

*according to OE requirements, approximated values



Did you know?

Every year, some

13.4 million

commercial vehicles with more than 6 tons of GVW circulate on European roads – covering an annual overall distance of some 145,000 km in long-haul traffic.

Diesel filter

Product details

Bosch diesel filters protect the injection system. They reliably separate particles and water from fuel and contribute to optimum engine performance.



Advantages at a glance

- ▶ **Excellent filter efficiency and reliable water separation** due to multilayered, microporous filter media
- ▶ **High particle holding capacity and low flow resistance** due to large filter surface
- ▶ **Moisture resistance and tensile strength** due to specially impregnated filter media
- ▶ **Protected against inner and outer leakage** due to high-quality processing and usage of resistant materials

Change diesel filters regularly as specified by the vehicle manufacturer!



Possible consequences of silted-up filters:

- ▶ Loss of engine power or even engine standstill
- ▶ Impairment of the fuel supply
- ▶ Impairments to the output of the fuel pump or even a short-circuit
- ▶ Internal corrosion of engine components

Diesel filter

Technology

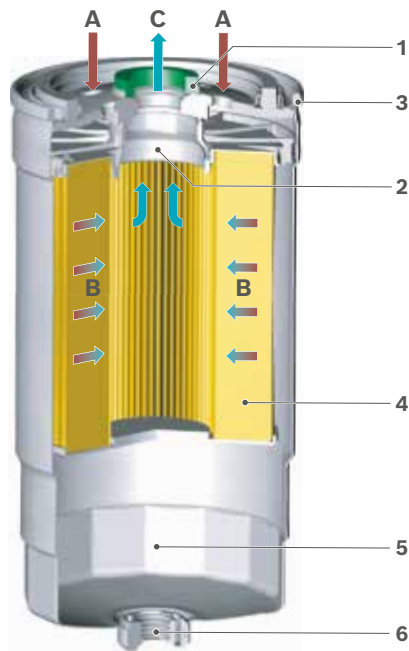

Design and operation

- 1 Seal
- 2 Threaded connection
- 3 Double beading
- 4 Multilayer filter media
- 5 Water accumulation chamber
- 6 Water drain screw

- A Inflow of contaminated diesel
 B Dirt and water filtration of diesel
 C Cleaned diesel is conducted to the engine

Common-rail system for up to 2,500 bar

Bosch system competence

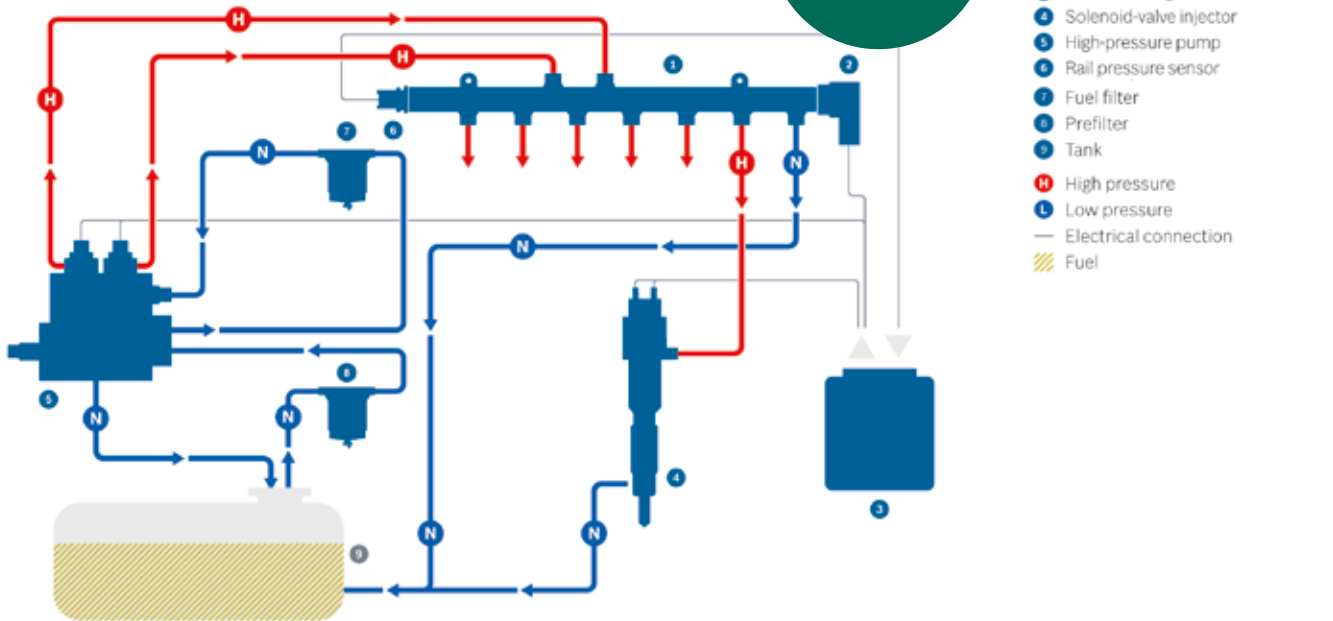

- 1 High-pressure rail
 - 2 Pressure control valve
 - 3 Electronic engine control unit
 - 4 Solenoid-valve injector
 - 5 High-pressure pump
 - 6 Rail pressure sensor
 - 7 Fuel filter
 - 8 Prefilter
 - 9 Tank
- H High pressure
 L Low pressure
 — Electrical connection
 Fuel

Diesel filter

Technology

Because of varying diesel quality

In global terms, the quality of diesel varies considerably. Depending on the region and the climatic conditions, the concentration of water and dust may be extremely high. Bosch thus provides various diesel filters exactly geared to the individual diesel qualities of the respective country.

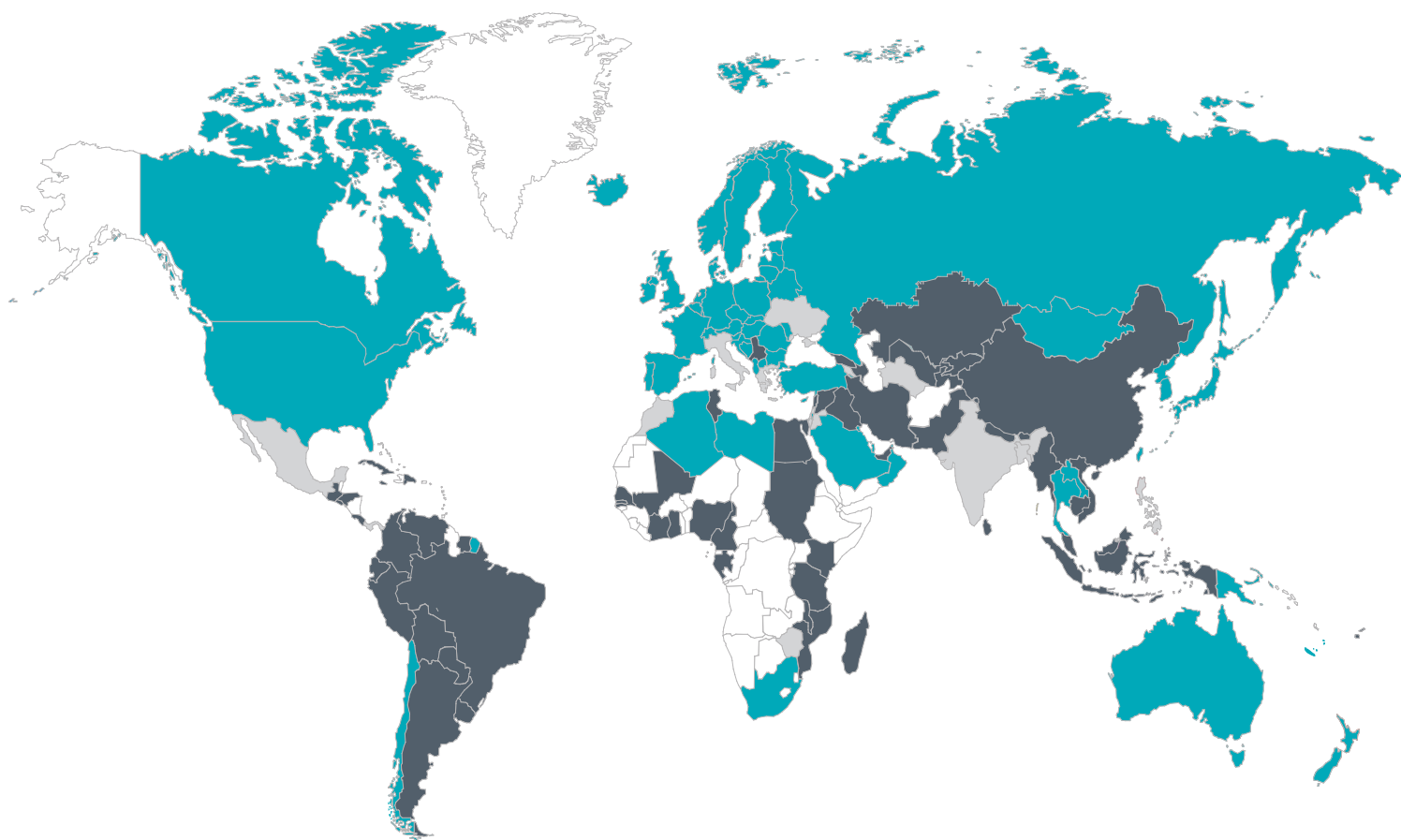

Source: SGS World Wide Fuel Surveys summer 2006 to winter 2010/2011

- ≤ 19 Established diesel markets
- = 20
- ≥ 21 } Increased impurity due to particles

Diesel prefilter

Product details

Bosch diesel prefilters support the function of the main diesel filter in commercial vehicles. They reliably separate coarse particles and water from the fuel thus ensuring the main diesel filter's service life. This helps to reduce the total cost of ownership.



Advantages at a glance

- ▶ **Excellent filter efficiency and reliable water separation** due to multilayered, microporous filter media
- ▶ **High particle holding capacity and low flow resistance** due to large filter surface
- ▶ **Protected against inner and outer leakage** due to high-quality processing and usage of resistant materials

Change the diesel prefilter regularly according to the vehicle manufacturer's specifications!



Particles contained in fuel

The particles contained in fuel are often mineral materials (sand). They end up in fuel as a result of dust from the atmosphere or dirt inside the tank or the supply pipes. But even corrosion or abrasion residues of metal and plastic components can mix with fuel. If those particles are not separated by the fuel filter, they can result in corrosion inside the fuel tank, mechanical grinding and early wear.

Diesel water separator

Product details

Bosch diesel water separators support the function of the main diesel filter in commercial vehicles. They reliably separate large amounts of water from the fuel thus ensuring the main diesel filter's service life. This helps to reduce the total cost of ownership.



Advantages at a glance

- ▶ **Excellent water separation** due to specially pleated, multilayered filter media
- ▶ **Low flow resistance** due to large filter surface
- ▶ **Protected against inner and outer leakage** due to high-quality processing and usage of resistant materials

Change the diesel water separator regularly according to the vehicle manufacturer's specifications!



Water contained in fuel

Any diesel fuel contains finely dissipated water. The water content depends on the fuel quality. Condensation inside the tank can increase the amount even further. Insufficient water separation – e.g. by non-compliance with replacement intervals or use of low-quality filters – can result in expensive corrosion damages on the engine, the high-pressure pump or even on the injectors.

Oil filter

Product details

Bosch oil filters protect the engine and engine components - e.g. the turbocharger. They reliably separate soot and metal abrasion from engine oil.



Advantages at a glance

- ▶ **Long service life of filter and engine oil** due to multilayered, specially impregnated filter media
- ▶ **High particle holding capacity** due to large filter surface
- ▶ **Excellent filter efficiency** due to specially designed and well balanced filter components
- ▶ **Reliable engine lubrication** in almost all temperature and oil pressure conditions
- ▶ **No oil loss** by corrosion-resistant housing materials and seals made of special rubber

Change oil filters and oil regularly as specified by the vehicle manufacturer!



Possible consequences of silted-up filters:

- ▶ Premature engine wear or even engine damage
- ▶ Reduced engine performance
- ▶ Increased oil consumption

Oil filter

Technology

Design and operation

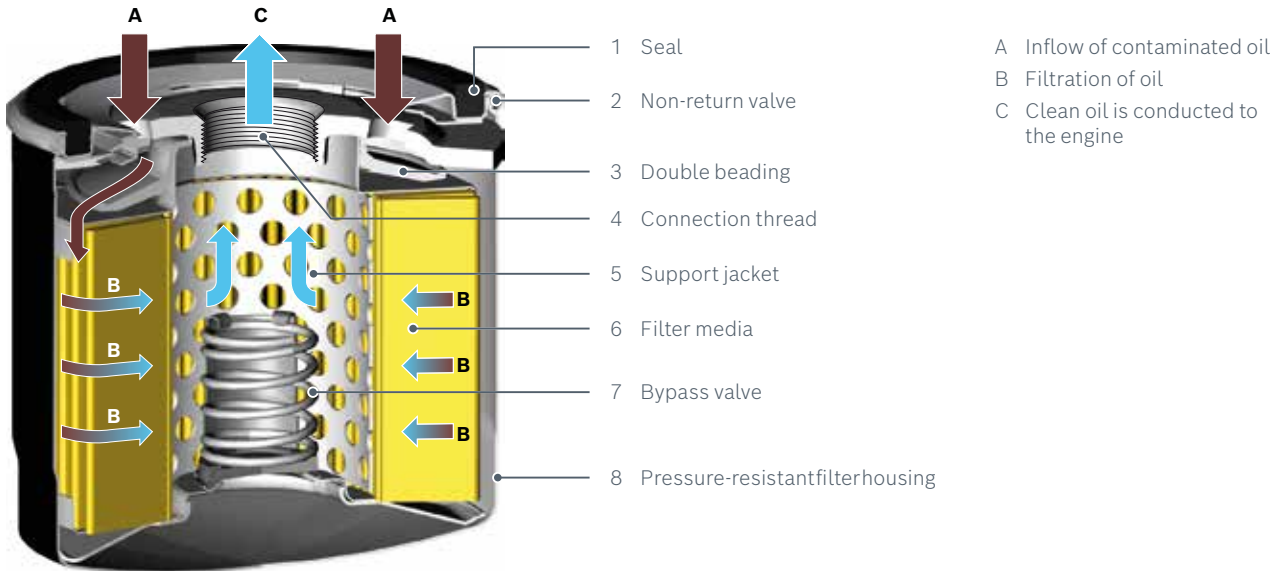

Bypass valve

- ▶ Ensures continuous oil supply for the engine at low ambient temperatures and protection when the filter is clogged through brief bypassing of the filter
- ▶ Less damage caused by impurities than by interrupted oil supply and cooling

Non-return valve

- ▶ Prevents idling of the oil filter after switching off the engine
- ▶ Immediate lubrication at restarts thanks to quick buildup of pressure

Centrifugal oil filter

Product details

Bosch centrifugal oil filters support the function of the main oil filter in commercial vehicles. They reliably separate ultrafine particles from the engine oil thus ensuring the main oil filter's service life and the lubrication properties of the engine oil. This helps to reduce the total cost of ownership.



Advantages at a glance

- ▶ **Longer service life of the main oil filter and engine oil** due to an effective secondary flow filtration of the oil
- ▶ **Reduced wear on engine components** due to removal of ultrafine (1micron) particles
- ▶ **High particle separation rate** due to centrifugal forces of up to 2000 times the force of gravity applied to the oil.

Change the centrifugal oil filter regularly according to the vehicle manufacturer's specifications!



Combined main-flow/bypass filter

- ▶ Main-flow filters: filtration of 100% of the oil
- ▶ Bypass filters: Additional fine filtration of 10% of the oil – delays oil aging

Air filter

Product details

Bosch air filters protect the engine and support a proper function of the sensors in the intake air duct. They reliably separate particles from intake air and contribute to optimum engine performance.

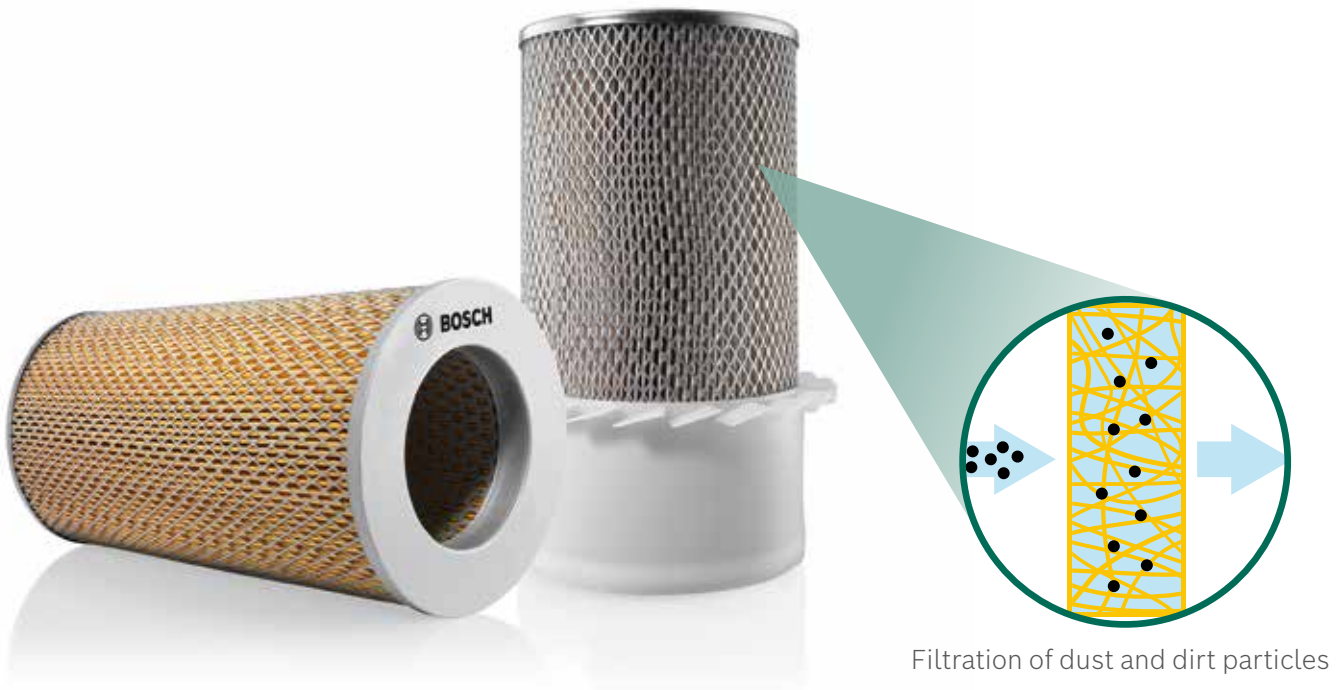

Advantages at a glance

- ▶ **Long service life, excellent filter efficiency, moisture resistance and tensile strength** due to multilayered, specially impregnated filter media
- ▶ **High particle holding capacity and low flow resistance** due to large filter surface
- ▶ **Robust fold geometry** due to filter media with special embossing
- ▶ **Appropriate fit** due to precise dimensions and high-quality sealing materials

Change air filters regularly as specified by the vehicle manufacturer!



Possible consequences of silted-up filters:

- ▶ Increased fuel consumption
- ▶ Reduced engine power
- ▶ Increased pollutant emissions

Secondary air filter

Product details

Bosch secondary air filters provide an important, additional safety function in commercial vehicles. In case of a damaged main air filter or during the change of the main air filter they protect the intake air duct from dirt particles thus reducing the risk of expensive downtimes.



Advantages at a glance

- ▶ **Long service life** due to usage of high-quality materials
- ▶ **Low flow resistance** due to special filter media
- ▶ **Stable fit** due to accurate dimensions and sealings

Change the secondary air filter regularly according to the vehicle manufacturer's specifications!



Cabin filters

Product range & details

Bosch cabin filters protect the vehicle occupants against pollen, fine dust as well as harmful and foul-smelling gases.



*Recommended replacement interval:
Cabin filters should be changed every
200 000 to 300 000 km. Please ob-
serve the manufacturer specifications!*

Function	Activated carbon filter	Standard filter
	Bosch activated carbon cabin filters – for noticeably purer and more pleasant air inside the car.	Bosch standard cabin filters – for clean air inside the car.
Separates foul-smelling and harmful gases (ozone, smog, exhaust gases)	●	
Separates pollen and fine dusts (up to 100% of 10µm)	●	●
Protects the air conditioning	●	●
Reduces dazzling effects	●	●
Coverage		
Advantages at a glance	<ul style="list-style-type: none"> ▶ Neutralizes reliably harmful and foul-smelling gases in an activated-carbon layer ▶ Filters effectively fine dusts, soot and pollen in an ultrafine microfiber layer ▶ Protects the air conditioner and improves the vision by reducing deposits 	<ul style="list-style-type: none"> ▶ Filters effectively fine dust, soot and pollen in an ultrafine microfiber layer ▶ Protects the air conditioner and improves the vision by reducing deposits

Cabin filters

Technology

Activated carbon filter

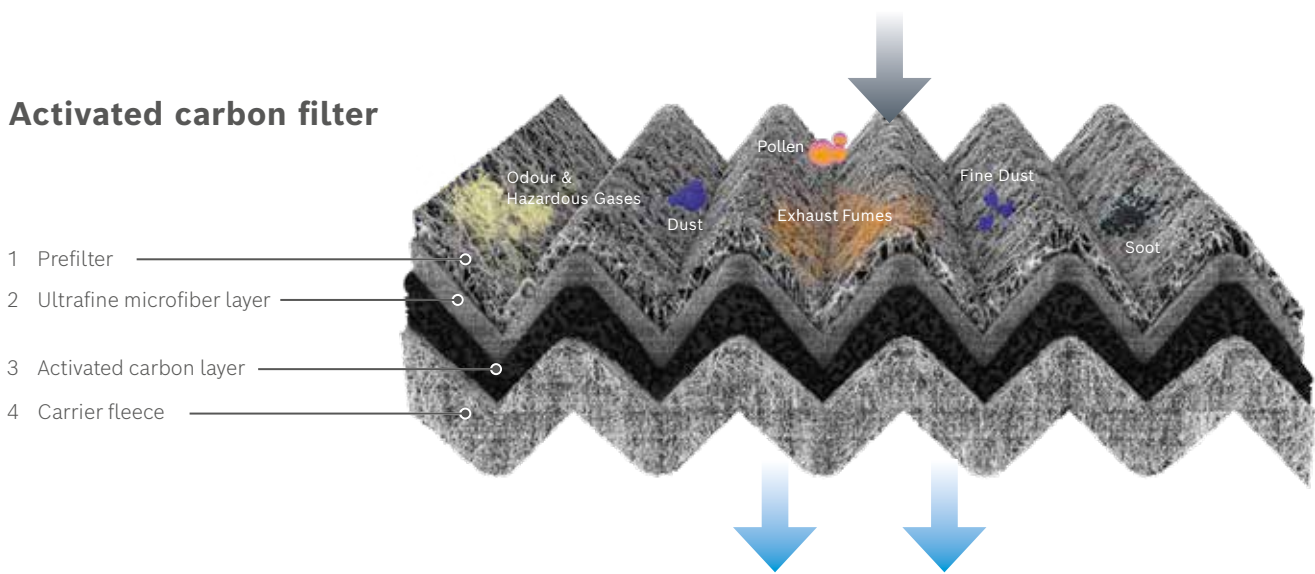

Standard filter

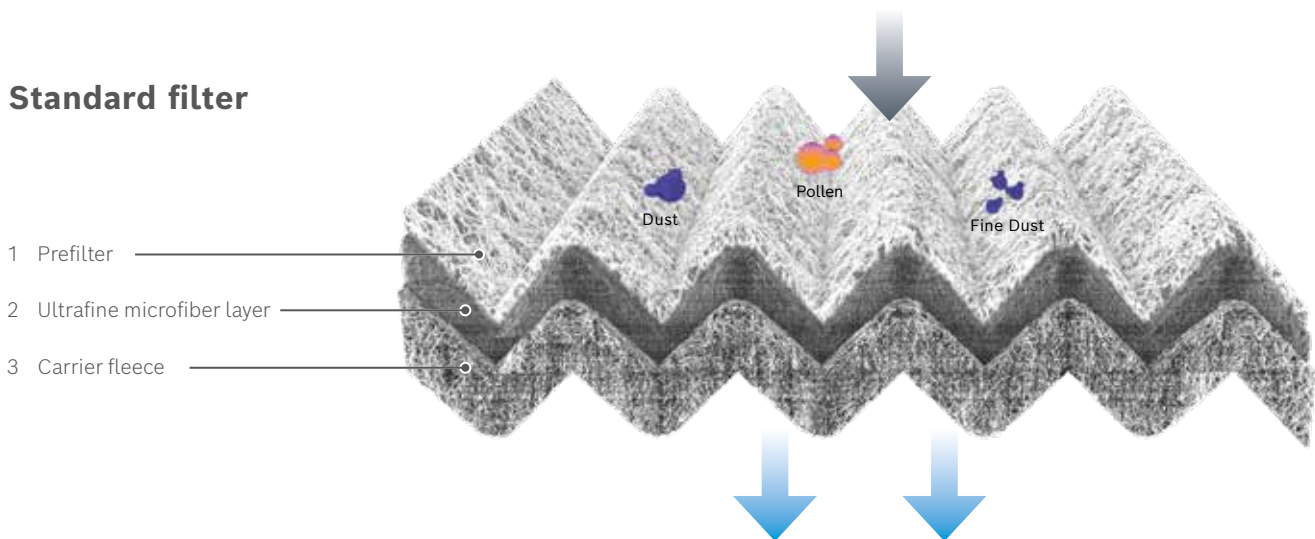

Possible consequences of silted-up filters:

- ▶ Poor vision due to misted windows, and thus reduced safety
- ▶ Increased concentration of pollutants inside the vehicle
- ▶ Allergic reactions, e.g. sneezing
- ▶ Restricted operation of the air conditioning system due to deposits on the evaporator



Did you know?

Activated carbon is made of coconut shells carbonized and crushed in a hermetically sealed environment. Water vapor with a temperature of

800° C

is used to create its sponge-like structure.

Denoxtronic filter

Product details

Bosch Denoxtronic filters protect the Denoxtronic injection system. They reliably remove particles from AdBlue thus contributing to optimum dosing.

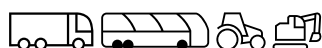

Advantages at a glance

- ▶ **High particle separation rate** due to microporous filter medium with special impregnation
- ▶ **High particle holding capacity** due to large filter surface
- ▶ **Chemical resistance to aggressive AdBlue** due to usage of high-quality materials
- ▶ **Frost resistance** due to compressible compensation elements

*Recommended replacement interval:
Denoxtronic filters must be replaced regularly.
Please observe the vehicle manufacturers'
specifications!*

? Did you know?

AdBlue is a watery urea solution composed of up to 32.5 % urea and up to 67.5 % demineralized water. Due to its high water content, AdBlue freezes and expands at just

-11° C.

In this case, compressible compensation elements prevent damage to both the filter and the supply module.

Denoxtronic filter

Technology

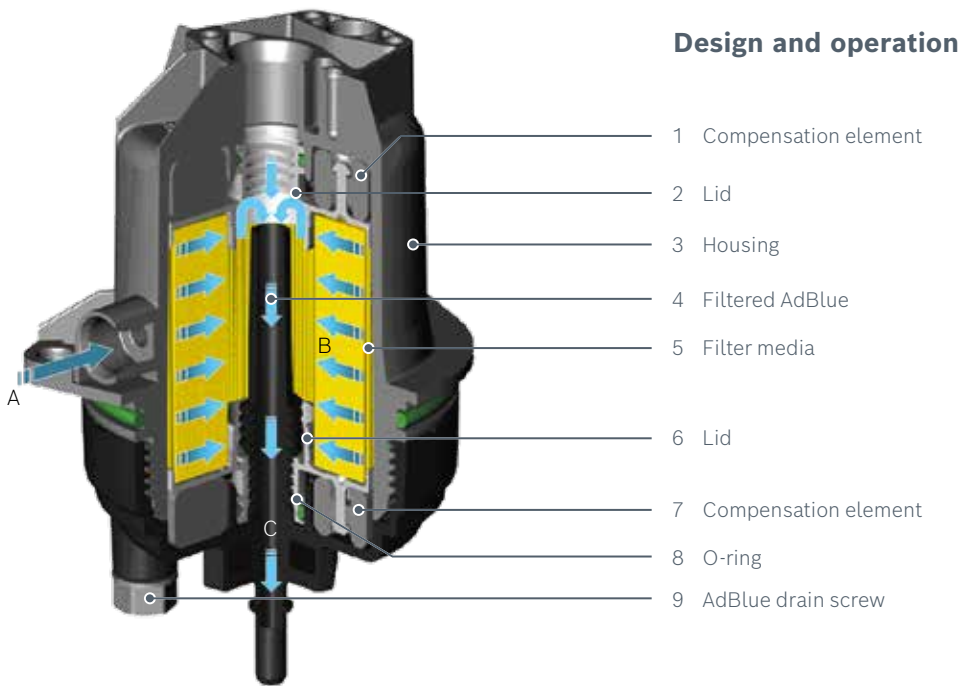



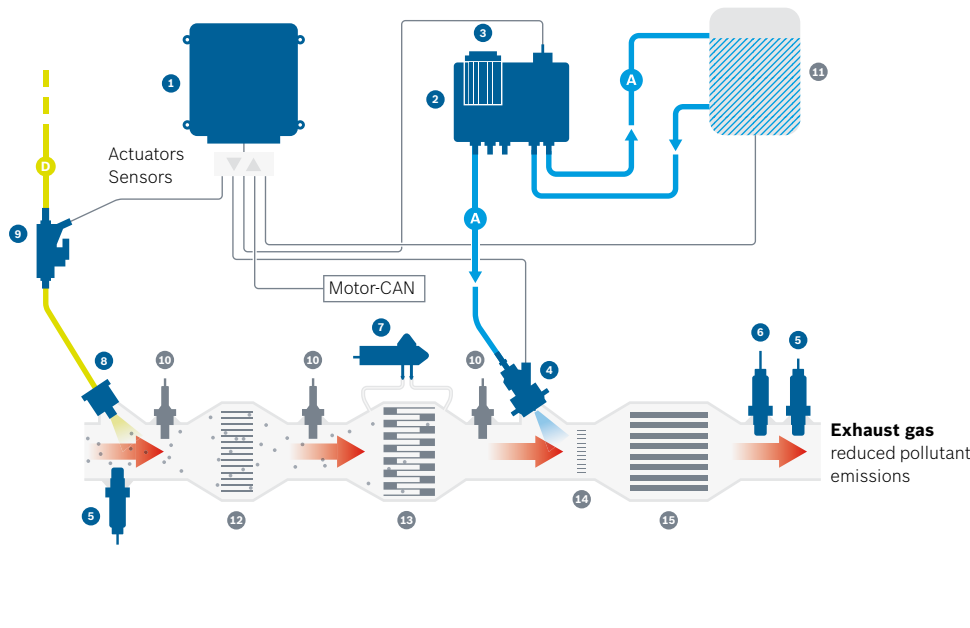





Denoxtronic exhaust-gas treatment and sensors (e.g. for Denoxtronic 2.2)



Denoxtronic filter

Product range

Spare-part sets for repairs and servicing

Typ/KIT										
Denoxtronic 1 Service	1 457 436 042		•	•		•	•	•		DAF, MAN, IVECO, Scania, Volvo
Denoxtronic 1 Repair	F 00B H40 025						•	•	•	DAF, MAN, IVECO, Scania, Volvo
Denoxtronic 2.1 Service	1 457 436 006		•				•	•		Case, IVECO, KHD, Renault, Volvo
Denoxtronic 2.1 Repair	1 457 030 020							•		Case, IVECO, KHD, Renault, Volvo
Denoxtronic 2.2 Service	1 457 436 088		•			•			•	Cummins, IVECO, Mack, Nissan, Renault, Volvo
Denoxtronic 6.5 Service	1 457 436 039		•			•			•	Perkins, IVECO, CNH, JCB, Daimler India, CAMC (China)
Denoxtronic 6HD Service	1 457 436 057		•			•			•	MAN, John Deere, IVECO, CNH



Filter with compensation element



Compensation element with sealing function



Pre-filter



Filter element



Set of seals



Filter cover



Compensation element



Drain plug



Extraction tool



Replacement of Denoxtronic 2.1 filters

The filter is screwed onto the housing cover of the Denoxtronic supply module and is extracted from the housing along with the cover. In case the filter detaches from the cover or gets stuck at the housing, it can be extracted using the extraction tool.



Replacement of Denoxtronic 2.2 filters

Using the extraction tool, the filter is extracted from the Denoxtronic supply module. The matching extraction tool is included within the service kit.

Air dryer cartridge

Product details

Bosch air dryer cartridges protect pneumatic systems of commercial vehicles against damages – e.g. the braking system. They dehumidify compressed air and reliably separate particles and oil mist thus reducing the risk of expensive downtimes.



Advantages at a glance

- ▶ **Large reserves for water absorption** due to usage of high-quality air dryer granulate
- ▶ **High resistance to pulsation and burst pressure** due to robust high-quality processing
- ▶ **Longer service life of air dryer granulate** by integrated oil separator

Air dryer cartridges shall be replaced annually. Please observe the vehicle manufacturers' specifications!



Possible consequences of poor dehumidification of compressed air

- ▶ Risk of malfunctioning valves due to frozen water – in case of cold weather
- ▶ Corrosion in air reservoirs as well as on valves and cylinders
- ▶ Erosion of oil lubricant film in brake-system components

Air dryer cartridge Technology

Design and operation

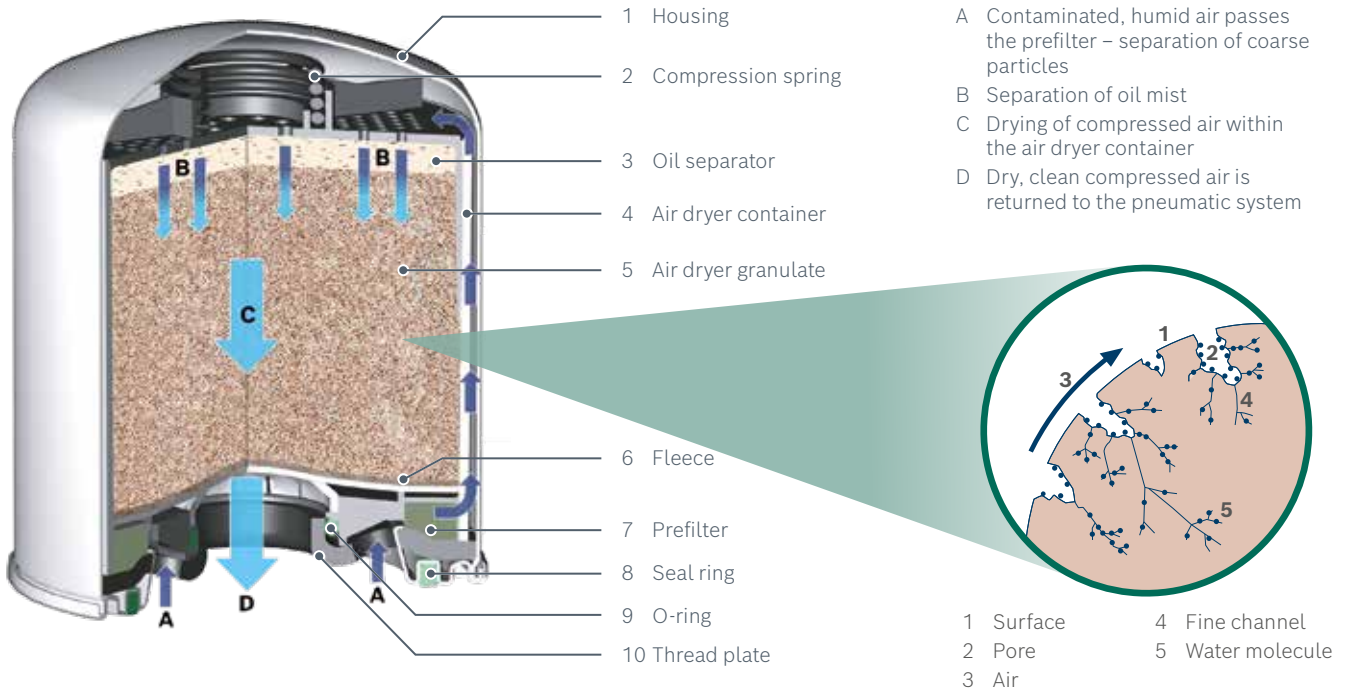

Bosch air dryer cartridge

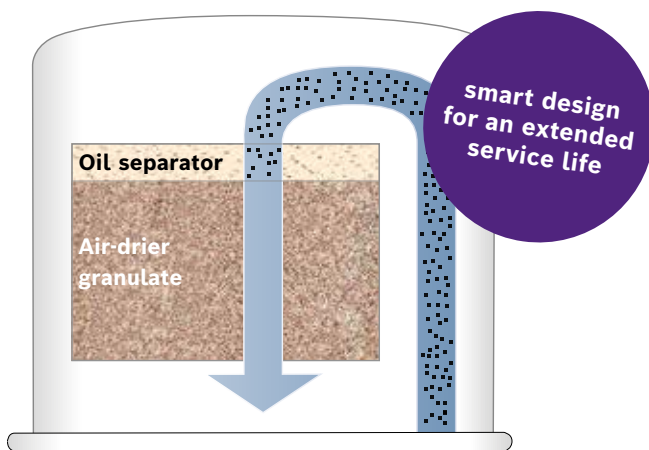

Oil mist is separated before reaching the air drier granulate
→ water-absorption capability remains fully intact, extended service life

Other air dryer cartridge

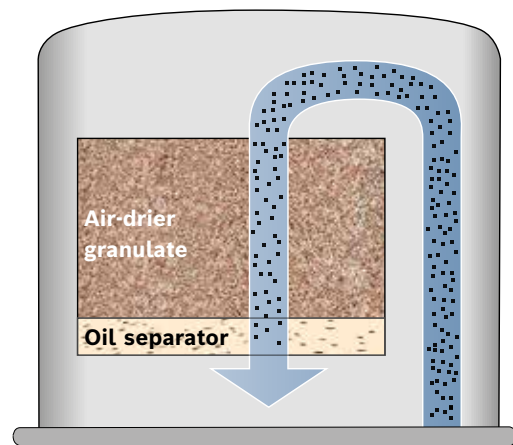

Oil mist is separated after reaching the air drier granulate
→ deteriorated water-absorption capability, reduced service life

Coolant filter

Product details

Bosch coolant filters protect the fine channels of the cooling system of commercial vehicles against deposits. They reliably separate particles and other residues from coolant, thus reducing the risk of expensive downtimes.



Advantages at a glance

- ▶ **High particle holding capacity** due to large filter surface and specially impregnated filter media
- ▶ **Long service life and engine protection** due to corrosion-resistant housing and coolant-resistant seals
- ▶ **Prevents bacterial growth, corrosion, chalk deposits and acidification** by easily soluble chemical additives

Coolant filters should be replaced regularly and together with the oil filter. Please observe the vehicle manufacturers' specifications!



Possible consequences of insufficient coolant filtration

- ▶ Pitting (corrosion within the cooling system)
- ▶ Premature wear of the coolant pump
- ▶ Deposits of calcium and magnesium
- ▶ Acidification and bacterial growth
- ▶ Particle residues within the cooling system

Coolant filter Technology

Design and operation

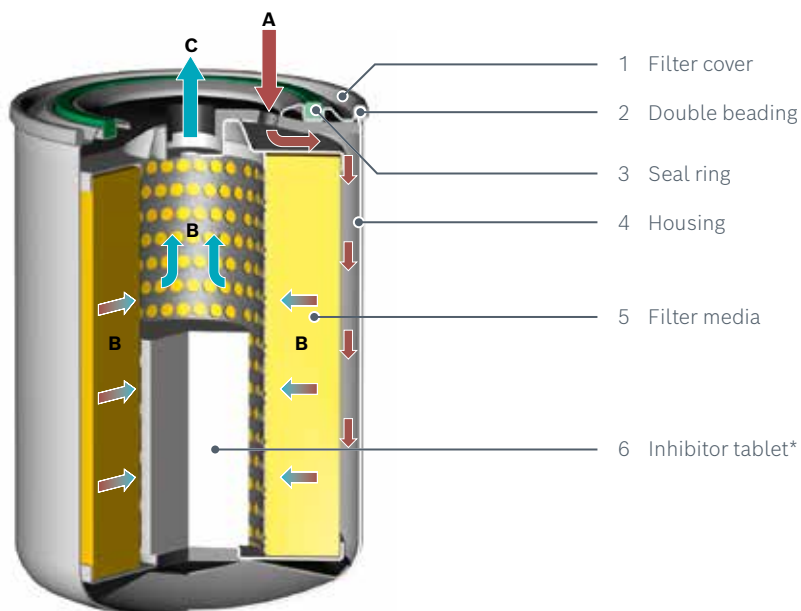

- A Inflow of contaminated coolant
- B Coolant is filtered and chemical additives are added
- C Cleaned coolant is conducted to radiator

*not standard



Insufficient coolant filtration can result in pitting. The result: damage to the cylinder due to corrosion.

KTS Truck: ECU diagnosis for CV electronics

- ▶ KTS Truck module for trucks, vans, trailers and buses
- ▶ KTS Truck can be connected to the Bosch DCU range and all common laptops/PCs via the USB port
- ▶ Integrated Bluetooth connection with a large range of up to 100 m
- ▶ Bluetooth USB adapter included
- ▶ Sturdy housing



Oil mist separator

Product details

Bosch oil mist separators protect the engine intake duct of commercial vehicles – e.g. the turbocharger – against damages. They reliably separate oil mist and particles from returned blow-by gases thus reducing the risk of expensive downtimes.



Advantages at a glance

- ▶ **Highly efficient oil separation and permanent particle collection** due to multilayer microfiber filter media
- ▶ **Protection of turbocharger**, charge air cooler and easing of the exhaust gas treatment system (in closed systems)
- ▶ **Cleaner ambient air** due to effective separation of oil mist (in open systems)

In short-distance and distribution traffic, oil mist separators should be changed every 40 000 km; in long-distance traffic, they should be replaced every 80 000 km. Please observe the vehicle manufacturers' specifications!



How are blow-by gases formed?

During engine operation, gases flow out of the combustion chamber, through the construction-borne gaps between piston and cylinder wall and into the crankcase. Even with optimum sealing, these blowby gases make up approximately 0.5 % to 2 % of the entire gas volume inside the cylinders. Blow-by gases contain fuel residues, soot particles and oil mist.

Hydraulic oil filter

Product details

Bosch hydraulic oil filters protect the hydraulic system of commercial and off-highway vehicles against damages. They reliably separate particles and other residues from hydraulic oil thus reducing the risk of expensive downtimes.



Advantages at a glance

- ▶ **Long filter service life and high particle holding capacity** due to specially designed and well balanced filter components
- ▶ **High particle separation rate** due to filter media made of synthetic or glass fibers
- ▶ **No oil loss** by corrosion-resistant housing materials and seals made of special rubber

Hydraulic oil filters should be replaced every 500 to 1 000 hours of operation, at latest once a year. Please observe the vehicle manufacturers' specifications!



Properties of hydraulic fluids

Hydraulic fluid is used to transmit pressures in hydraulic systems. These pressures can be up to 400 bar, thus demanding hydraulic fluids to meet tough requirements:

- ▶ Low temperature sensitivity for viscosity (fluidity)
- ▶ Low compressibility
- ▶ Low tendency to form foams
- ▶ High shear stability, i.e. no rupture of the lubricant film – even if subject to high mechanical strains

“Racing implies a constant search for optimization potentials. A reliable partner is thus a huge support. Bosch workshop equipment and parts feature a particularly high quality. That’s material for professionals.”

Jochen Hahn



Team Hahn Racing

Successful with Bosch

Since 2000, Jochen Hahn's participation at the FIA European Truck Racing Championship (ETRC) has been highly successful – bringing him six titles as European champion and two as vice champion since 2011. This success is facilitated by his Team Hahn Racing, a real family business run by him, his wife and his children. For several years, Bosch has been supporting Team Hahn Racing providing both technology and know-how. The European truck motor racing series ETRC is a real crowd-puller attracting more than 800 000 spectators at roughly eight events each year.

Bosch technology inside the race truck



Battery

Bosch S5 battery with PowerFrame technology: more power right from the start



Diesel injection system

Diesel injection system with EDC7U control unit and unit injectors for excellent fuel injection



Alternator

Heavy Duty alternator for reliable power supply



Ribbed V-belts

Bosch ribbed V-belts provide top performance in racing applications



Filters

The fuel-filter replacement box and the oil filter protect both the injection system and the engine



Sensors

Crankshaft, camshaft and intake-manifold pressure sensors provide accurately measured data



Relays

Bosch relays – reliably and safely switch high currents within the race truck



Fuses

Bosch fuses protect cables, harnesses and devices against overloads or short circuits



Wiper

Bosch Aerotwin wiper blades – highly esteemed in racing for their high wiping performance

Team Hahn Racing

Successful with Bosch

“Racing implies constant search for potential improvements. A reliable partner is thus a huge support. Bosch workshop equipment and parts feature a particularly high quality. That’s material for professionals.”

Jochen Hahn

Since 2000, Jochen Hahn’s participation at the FIA European Truck Racing Championship (ETRC) has been highly successful – bringing him six titles as European champion and two as vice champion since 2011. This success is facilitated by his Team Hahn Racing, a real family business run by him, his wife and his children. For several years, Bosch has been supporting Team Hahn Racing providing both technology and know-how. The European truck motor racing series ETRC is a real crowd-puller attracting more than 800 000 spectators at roughly eight events each year.

Bosch technology inside the race truck

- ▶ Bosch S5 battery with PowerFrame technology: more power right from the start
- ▶ Diesel injection system with EDC7U control unit and unit injectors for excellent fuel injection
- ▶ Heavy Duty alternator for reliable power supply
- ▶ Bosch ribbed V-belts provide top performance under racing conditions
- ▶ Fuel-filter replacement box and oil filter protect both injection system and engine
- ▶ Crankshaft, camshaft and intake-manifold pressure sensors provide accurately measured data
- ▶ Bosch relays – reliably and safely switch high currents within the race truck
- ▶ Bosch fuses protect cables, harnesses and devices against overloads or short circuits
- ▶ Bosch Aerotwin wiper blades – highly esteemed in racing for their high wiping performance



What drives you, drives us

Bosch technologies are used in most vehicles worldwide. People, and assuring their mobility, is what we are focused on.

Therefore, we have dedicated over 130 years of pioneering spirit and expertise in research and manufacturing to achieving this.

We provide the aftermarket and workshops worldwide with modern diagnostic and workshop equipment and a wide range of spare parts for passenger cars and commercial vehicles:

- ▶ Solutions for efficient and effective vehicle repairs
- ▶ Innovative workshop equipment and software
- ▶ One of the world's most comprehensive ranges of new and exchange parts
- ▶ Large network of wholesale customers, for quick and reliable parts supply
- ▶ Competent technical support
- ▶ Comprehensive educational and training offers
- ▶ Targeted sales and marketing support

Find out more at:
boschaftermarket.com

Robert Bosch GmbH
Automotive Aftermarket

Auf der Breit 4
76227 Karlsruhe
Germany

